

Denis
Surgical

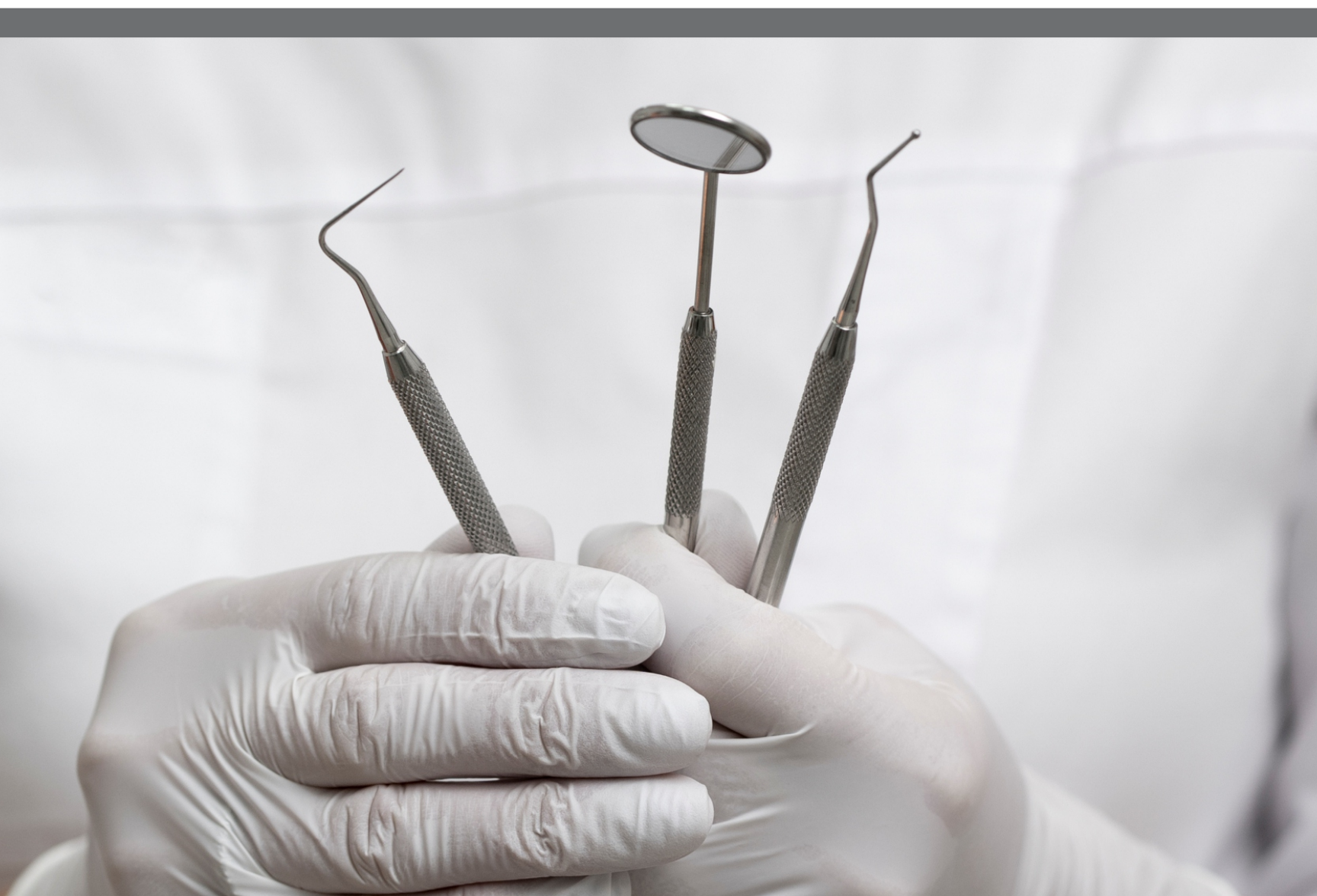

DENTAL INSTRUMENTS CATALOGUE
www.denissurgical.com

50



Extracting Forceps, American Pattern
Zahnzangen, Amerikanische Form
Daviers, forme américaine
Forceps de extracción, forma americana
Pinze per estrozione, forma americana

Page 01 to 15

51



Extracting forceps, English pattern
Zahnzangen, Englische Form
Daviers, forme anglaise
Fórceps dentales, forma inglesa
Pinze per estrazione, forma inglese

Page 16 - 38

52

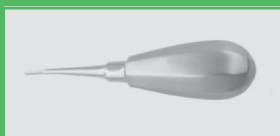

Root Elevators
Wurzelheber
Elévateurs á racines
Botadores para raíces
Leve per radici

Page 40 to 54

53



Bone Files
Bone-Dateien
Archivos de huesos
Fichiers d'os
Bone Files

Page 55 to 56

54



Dental Probes
Zahnsonden
Sondas dentales
Sondes dentaires
Sonde dentali

Page 57 to 58

55

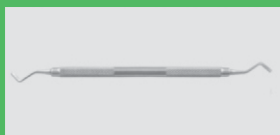

Enamel Instruments
Emaile-Instrumente
Instrumentos de esmalte
Instruments d'émail
Strumenti per smalto

Page 59 to 62

56



Dental Scalers
Zahnsteinentferner
Escaladores dentales
Scalers dentaires
Scaler dentali

Page 63 to 78

57

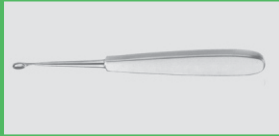

Bone Crettes
Knochenküretten
Curetas de hueso
Curettes osseuses
Curette d'ossa

Page 79 to 84

58

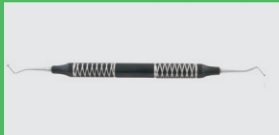

Excavators
Bagger
Excavadoras
Pelles
escavatori

Page 85 to 89

59



Wax Proclein
Wachs-Porzellan
cera Porcelana
Cire Porcelaine
Cera porcellana

Page 90 to 94

60

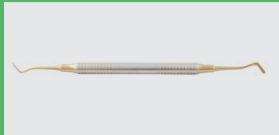

Filling Instruments
Füllungsinstrumente
Actos de llenado
Instruments de remplissage
Strumenti di riempimento

Page 95 to 105

61



Gingivectomy Knives
Gingivektomie Messer
Cuchillos de gingivectomía
Couteaux de gingivectomie
Coltelli per gingivectomia

Page 106 to 107

62



Cement Spatulas
Zementspatel
Espátulas de cemento
Spatules de ciment
Spatole di cemento

Page 108 to 112

63



Mouth Mirrors
Mundspiegel
Espejos bucales
Bouche Miroirs
Bocca specchi

Page 113 to 115

64



Amalgam Instruments
Amalgam Instrumente
Instrumentos de amalgama
Instruments Amalgam
Strumenti amalgama **Page 116 to 117**

65



Matrix Retainers
Matrix-Halterungen
Retenedores de matrices
Retenue de matrice
Matrix Retainers **Page 118 to 125**

66



Hemostatic Forceps
Arterienklemmen
Pinces hemostaticas
Pinzashemostaticas
Pinze emostatiche **Page 126 to 132**

67



Towel Clamps
Handtuchklammern
Abrazaderas de toalla
Pinces à serviettes
Morsetti per asciugamano **Page 133 to 134**

68



Needle Holders
Nadelhalter
Porte-aiguilles
Porta-agujcs
Port' aghi **Page 135 to 143**

69



Retractors
Wundhaken
Ecarteurs
Separadores
Divaricatori **Page 144 to 148**

70

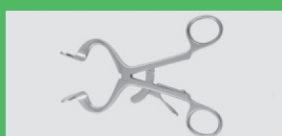

Mouth and Tongue
Mund und Zunge
Boca y la lengua
Bouche et langue
Bocca e la lingua **Page 149 to 152**

71



**Scissors
Schere
Tijeras
Les ciseaux
Forbici**

Page 153 to 168

72



**Micro Scissors
Mikroschere
Micro tijeras
Micro-ciseaux
Micro forbici**

Page 169 to 170

73



**Orthodontics
Kieferorthopädie
Ortodoncia
Orthodontie
Ortodonzia**

Page 171 to 187

74



**Bone Rongeurs
Knochen Rongeur
Rongeurs de hueso
Os Rongeurs
Bone Rongeurs**

Page 188 to 190

75



**Forceps
Zange
Fórceps
Forceps
forcipe**

Page 191 to 198

76



**Scalpel Handles
Skalpelli
Manches de bistouris
Mangos de Bisturías
Manici per bisturi**

Page 199 to 200

77

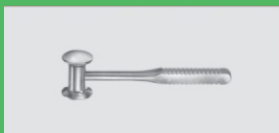

**Mallets
Schlägel
Mazos
Maillets
Mallets**

Page 201 to 203

78



**Cassettes
Kassetten
Cassettes
Cassettes
cassette**

Page 204 to 207

79



**Cylinder cartridge syringe
Zylinder-Ampullenspritze
Seringue á ampoule cylindrique
Jeringo para cartucho ampollas
Siringe ampollare a cilindro**

Page 208 to 213

80



**Impression Trays
Abdrucklöffel
Porte empreintes
Cubetas para impresiones
Portaimpronte**

Page 214 to 225

81



**Articulators
Artikulatoren
Articuladores
Articulateurs
articolatori**

Page 226 to 227

82



**Holloware
Holloware
holloware
Platerie
Holloware**

Page 228 to 231



Denis
Surgical

50

- EN** Extracting Forceps, American Pattern
- DE** Zahnzangen, Amerikanische Form
- ES** Daviers, forme américaine

Page 01 to 15





Fig. 1

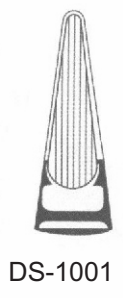

HENAHAN
Fig. 1 A

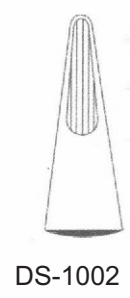
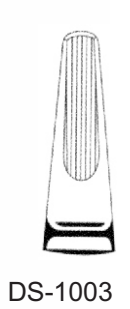

Fig. 1 B



MILWAUKEE
Fig. 3



WOODDS-WARD
Fig. 3 FH

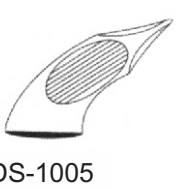



DS-1006

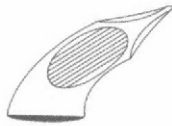

WOODDS-WARD
Fig. 3 FS



DS-1007

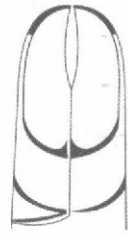

PHYSICK
Fig. 5

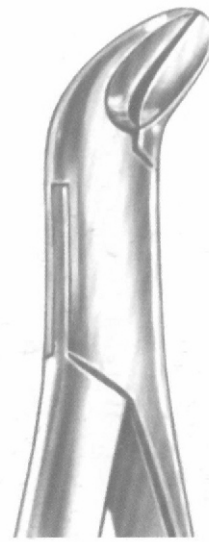

DS-1008

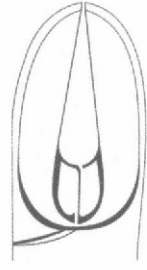

Fig. 6



DS-1009

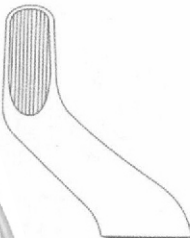

Fig . 10 H



DS-1010

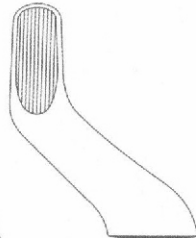

Fig . 10 S



DS-1011



HARRIS
Fig . 15

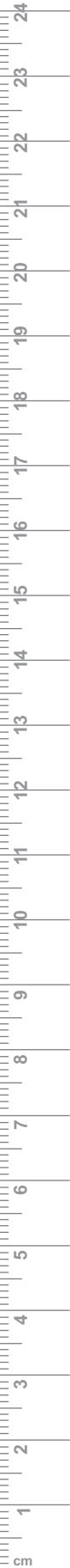

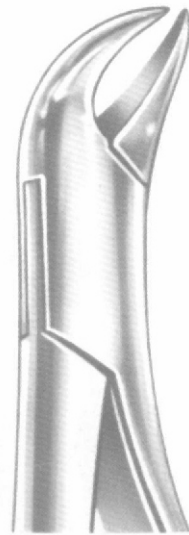

HARRIS
Fig. 16



DS-50DS-1012



Fig. 16 S

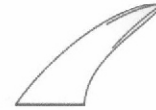

DS-50DS-1013



Fig. 17



DS-50DS-1014



HARRIS
Fig. 18 L



DS-50DS-1015



HARRIS
Fig. 18 R



DS-50DS-1016

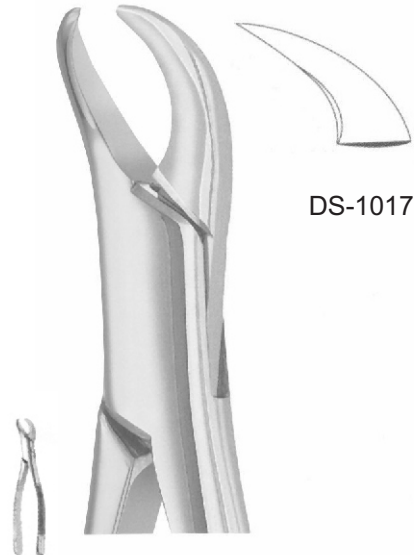

DS-1017

Fig. 23

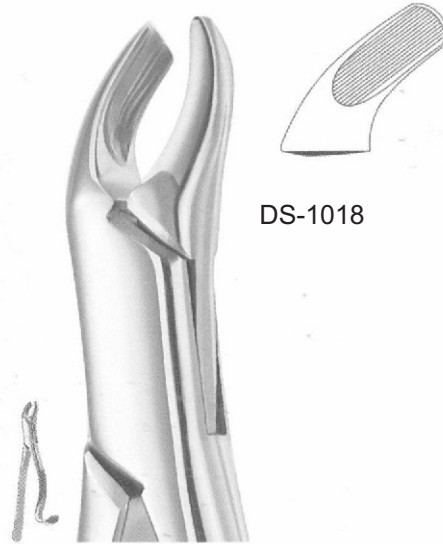

DS-1018

Fig. 24

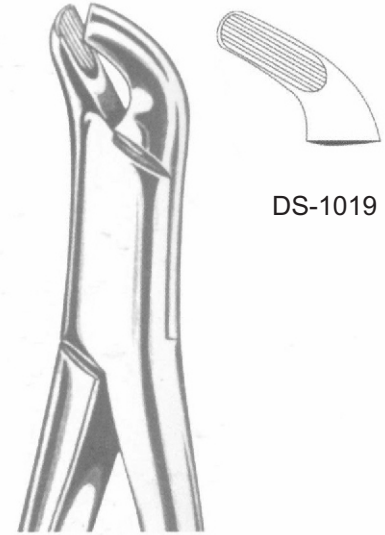

DS-1019

Fig. 27



DS-1020

PARMLY
Fig. 32

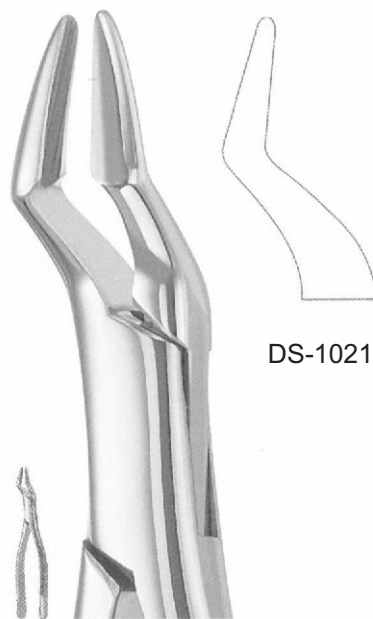

DS-1021

PARMLY
Fig. 32 A

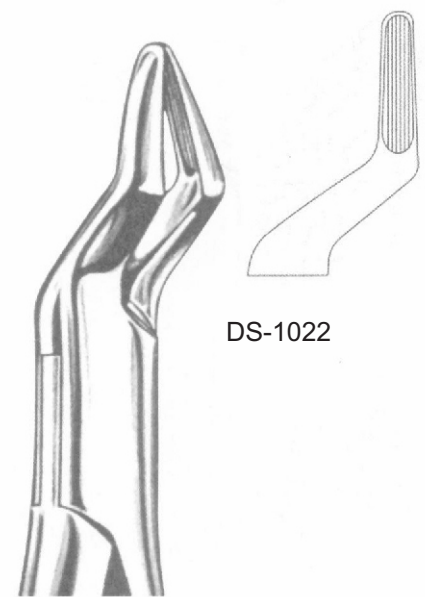

DS-1022

Fig. 35





DS-1023



DS-1024

Fig. 53 L

Fig. 53 R



Fig. 62



DS-1025

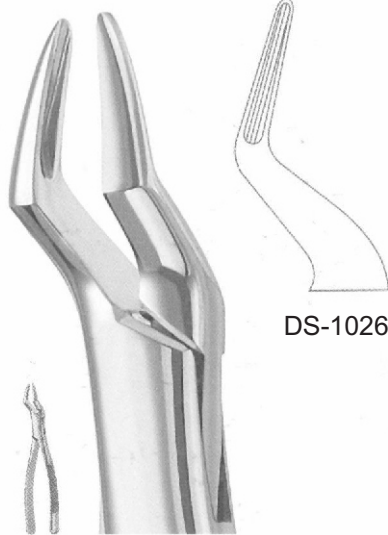

Fig. 65



DS-1026



TOMES
Fig. 69



DS-1027



THOMAS
Fig. 85



DS-1028



THOMAS
Fig. 85 A



DS-1029

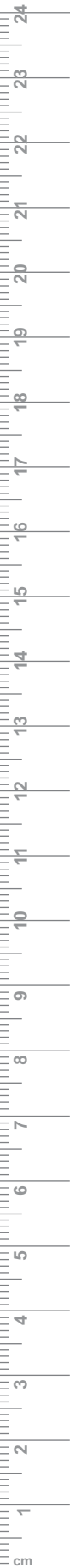



NEVIUS
Fig. 88 L



DS-1030



NEVIUS
Fig. 88 R

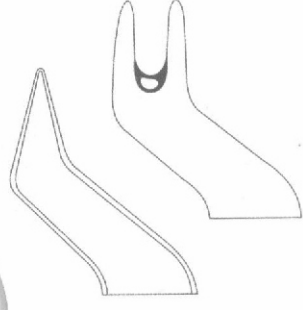

DS-1031



KELLS
Fig. 99 A

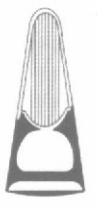

DS-1032



KELLS
Fig. 99 C

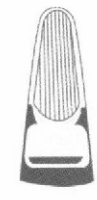

DS-1033



HULL
Fig. 101



DS-1034



Fig. 103

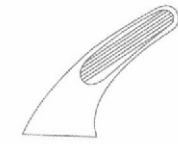

DS-1035



Fig. 10 H



DS-1036

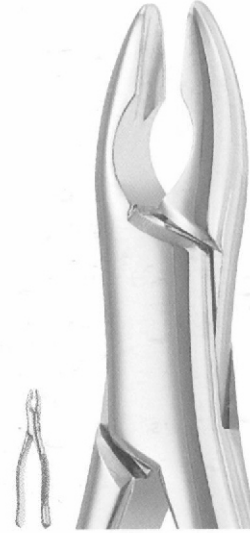

Fig. 10 S



DS-1037



CRYER
Fig. 150



DS-1038

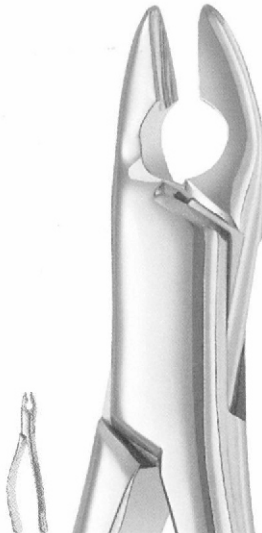

CRYER
Fig. 150 A



DS-1039



Fig. 150 X

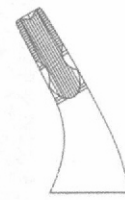

DS-1040

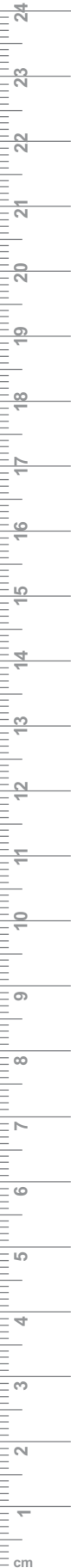



DS-1041



DS-1042



DS-1043

Fig. 150 AB

Fig. 150 AS

CRYER
Fig. 150 S



CRYER
Fig. 151

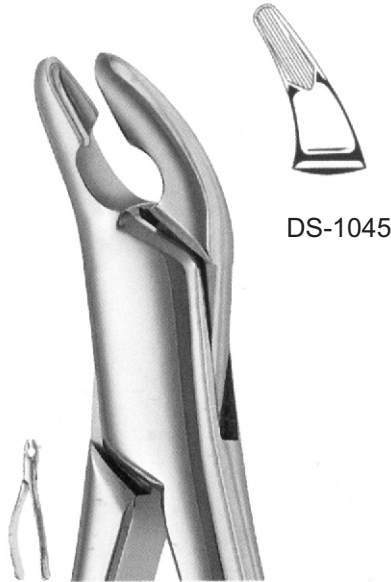

CRYER
Fig. 151 A

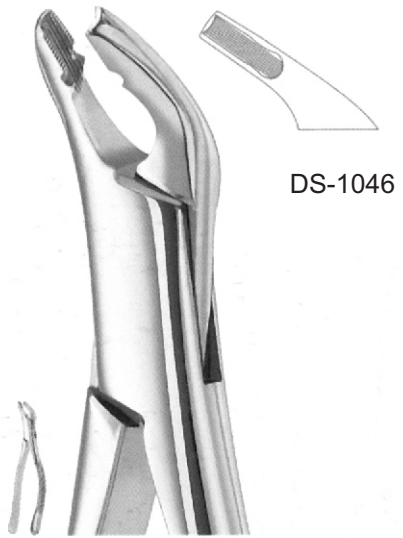
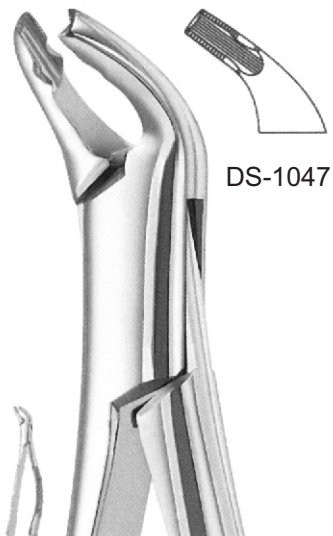
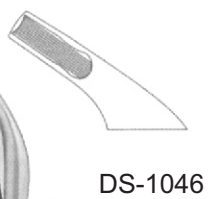

Fig. 151 X



CRYER
Fig. 151 AB

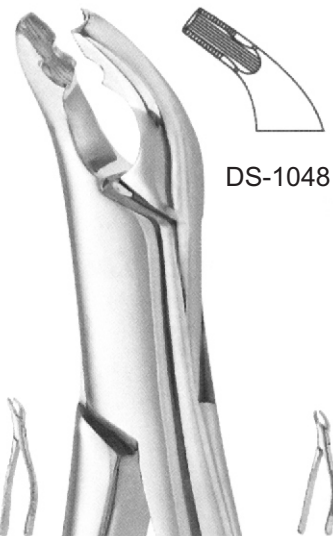
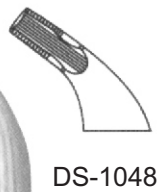

Fig. 151 AS



CRYER
Fig. 151 S



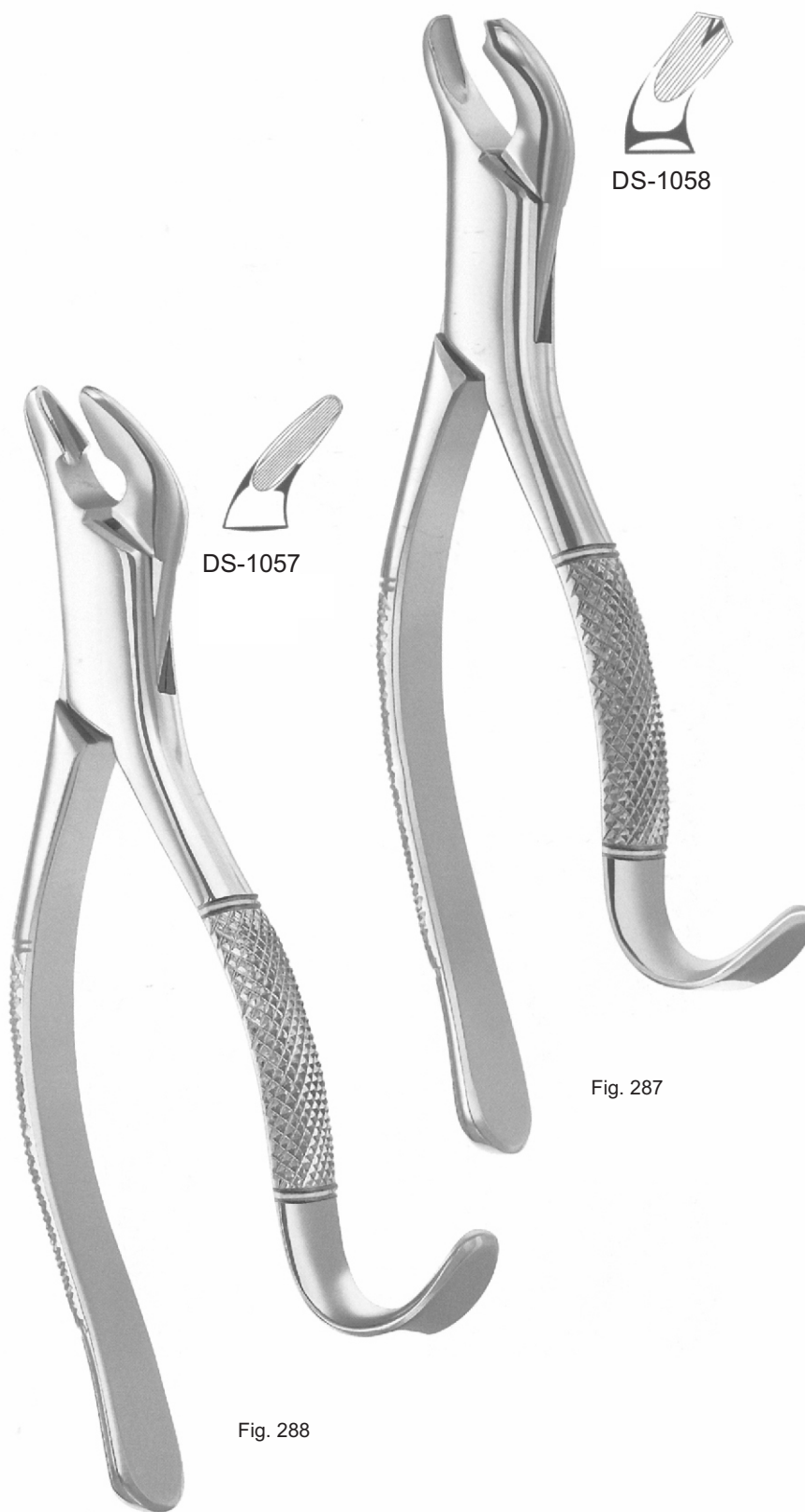



Fig.201

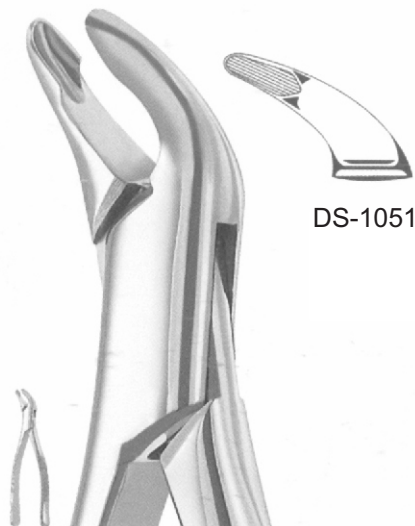

Fig.203

DS-1051

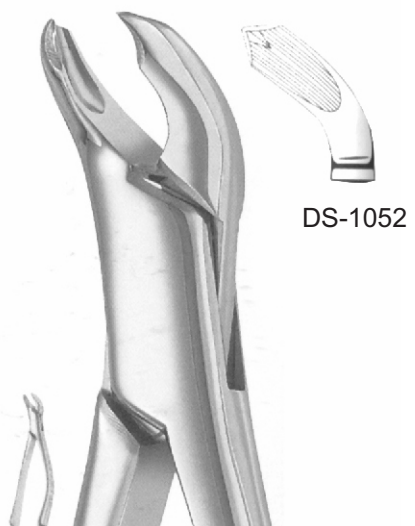

Fig.217

DS-1052

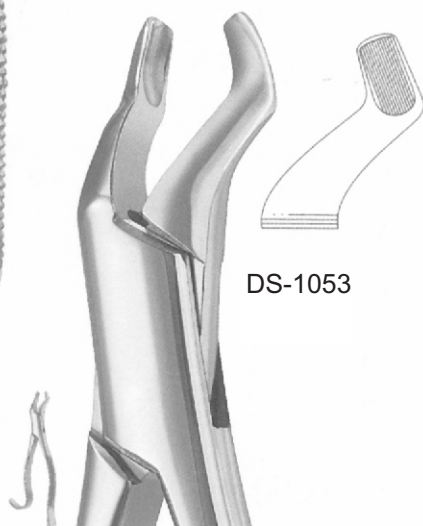

Fig.210 H

DS-1053

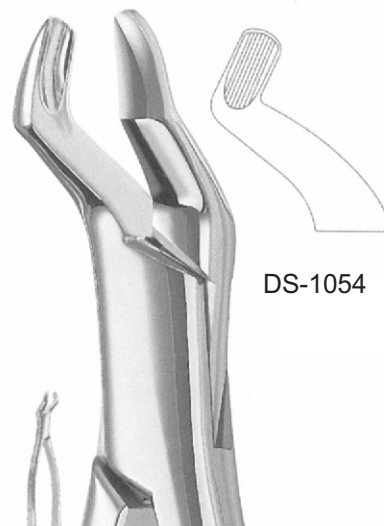

Fig.210 S

DS-1054

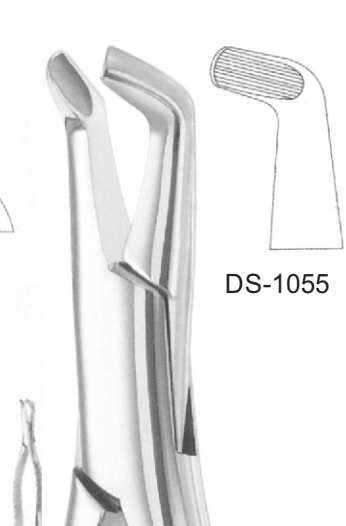
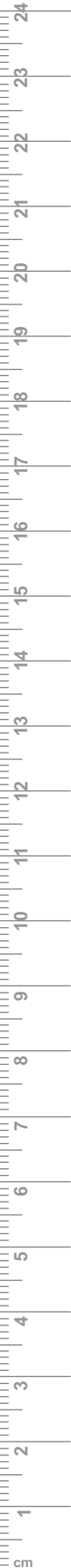

Fig.222

DS-1055



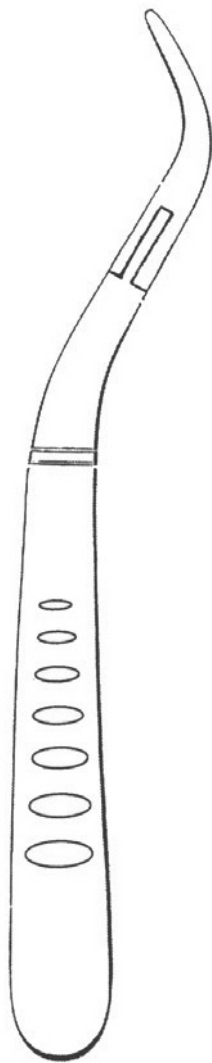

Fig.300



DS-1059

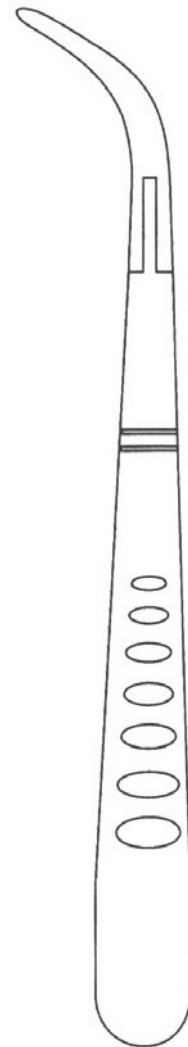
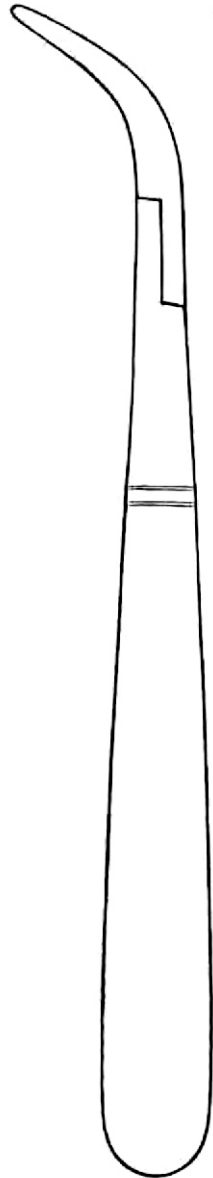

Fig.301



DS-1060



DS-1061
WITZEL
Fig.501

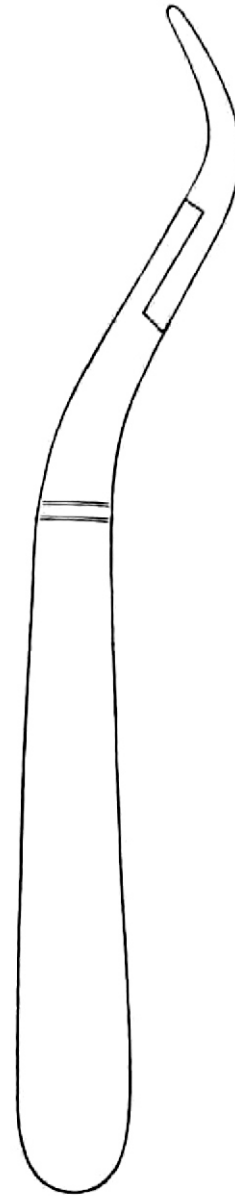

DS-1062
WITZEL
Fig.502





DS-1063

Fig. 17 SK



DS-1064

Fig. 23 SK



DS-1065

Fig. 150 Sk



DS-1066

Fig. 151 Sk





Denis
Surgical

51

- EN** Extracting forceps, English pattern
- DE** Zahnzangen, Englische Form
- ES** Daviers, forme anglaise

Page 16 DS- 38





Fig. 1

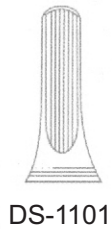

DS-1101

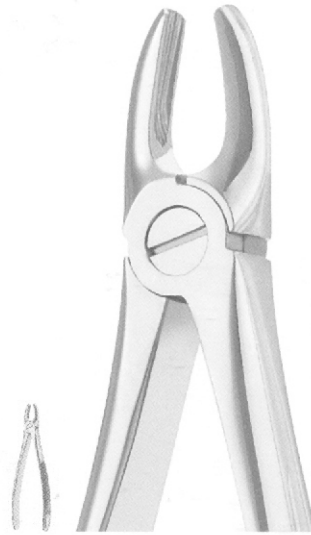

Fig. 2



DS-1102



Fig. 3

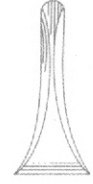

DS-1103



Fig. 4



DS-1104



Fig. 7



DS-1105

EXTRACTING FORCEPS ENGLISH

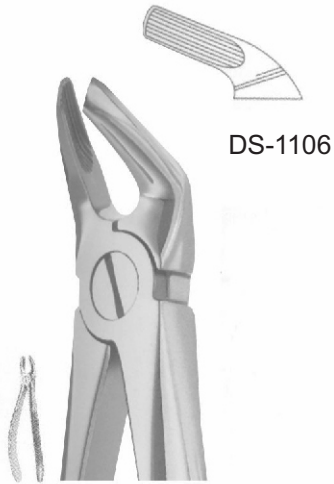

Fig. 8



Fig. 13

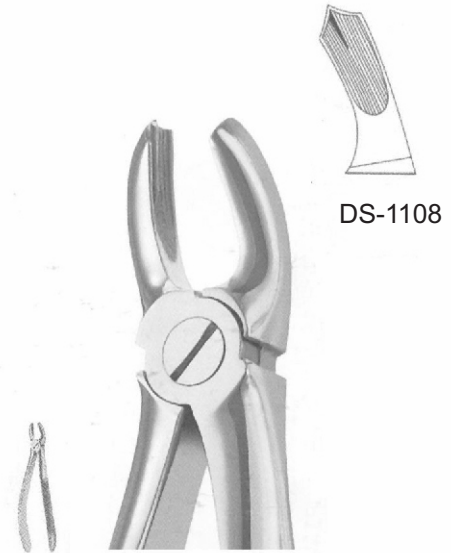

Fig. 17

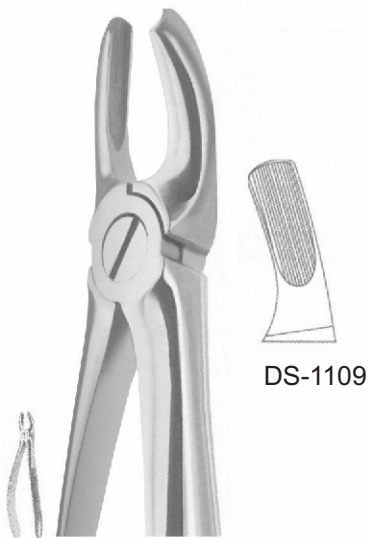

Fig. 18

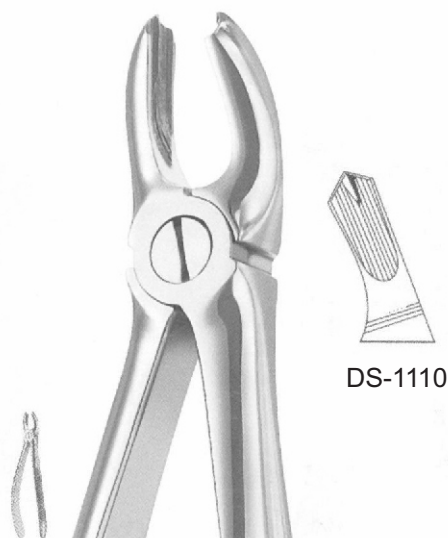

Fig. 18 A



Fig. 19

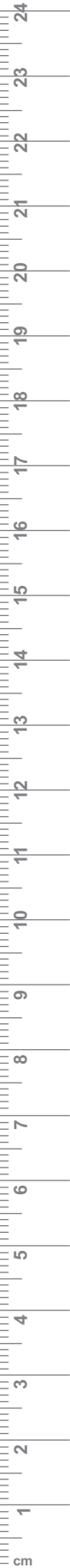



Fig. 20

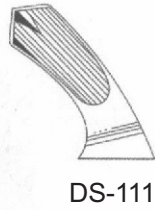

Fig. 21



Fig. 22

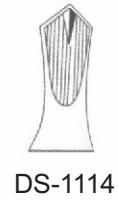

Fig. 23

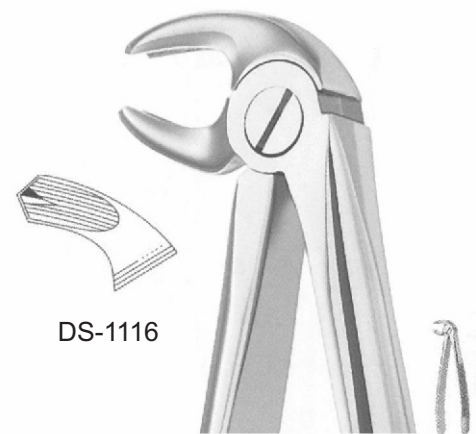
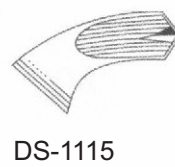

Fig. 24



EXTRACTING FORCEPS ENGLISH

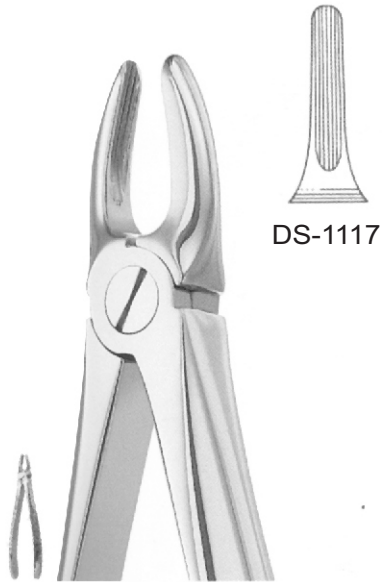

Fig. 29

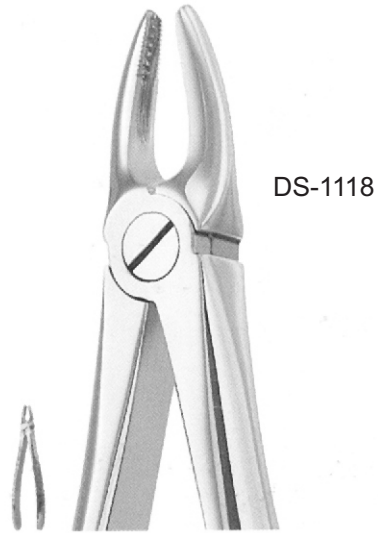

Fig. 29 N



Fig. 30



Fig. 31



Fig. 32
DS-1121

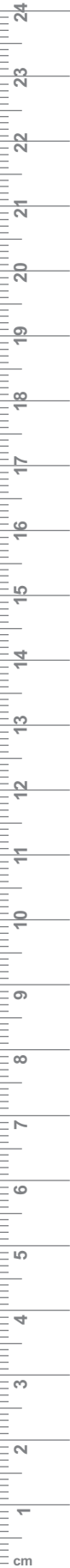
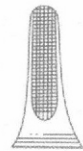



Fig. 33



DS-1122



Fig. 33 A

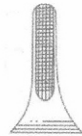

DS-1123



Fig. 33 C

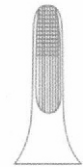

DS-1124



Fig. 33 M

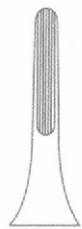

DS-1125



Fig. 33 W



DS-1126

EXTRACTING FORCEPS ENGLISH



DS-1127

Fig. 34



DS-1128

Fig. 35



DS-1129

Fig. 36

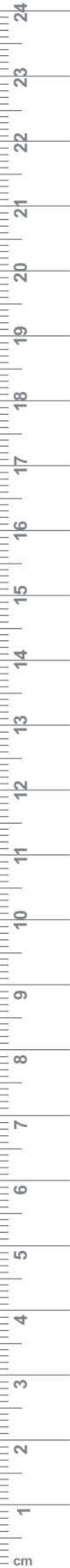



Fig. 41



DS-1130

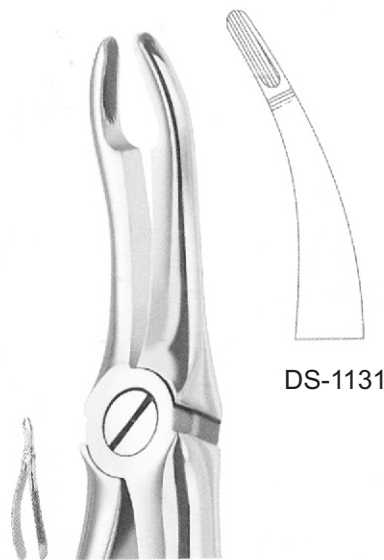

Fig. 44



DS-1131

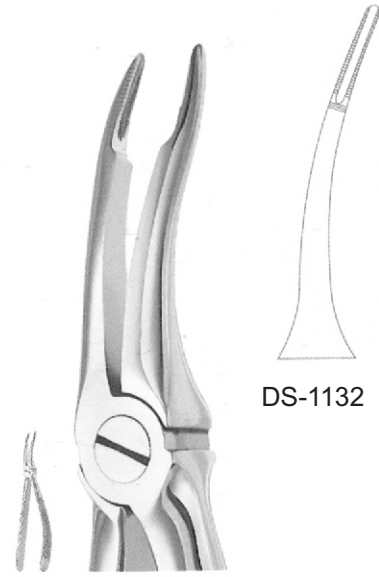

Fig. 44 F



DS-1132



Fig. 45



DS-1133



Fig. 45 F



DS-1134



Fig. 46 L



DS-1135

EXTRACTING FORCEPS ENGLISH



Fig. 51

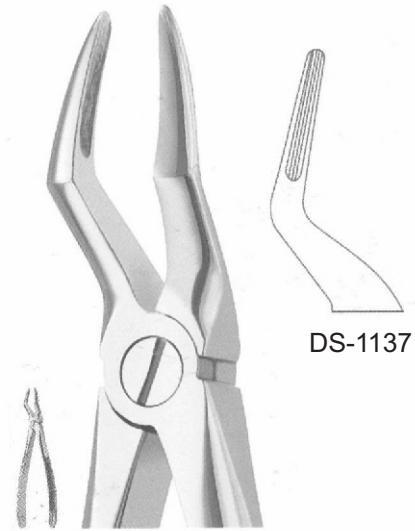

Fig. 51 A

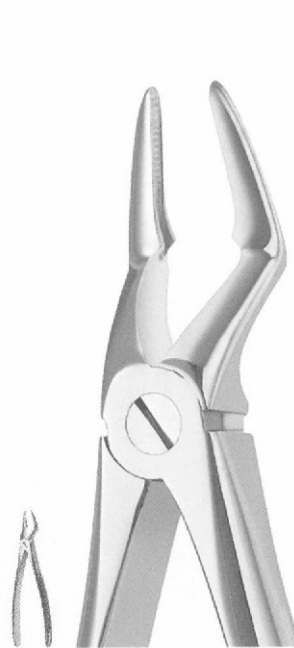

Fig. 51 C

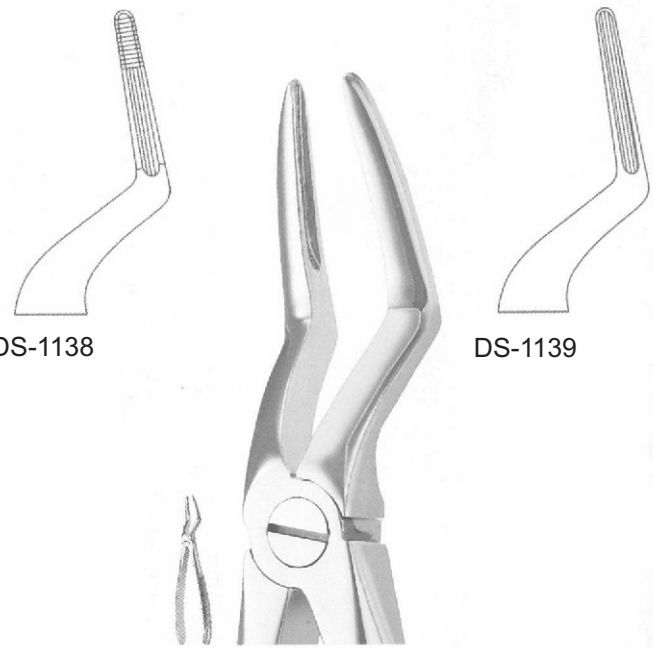

Fig. 51 L

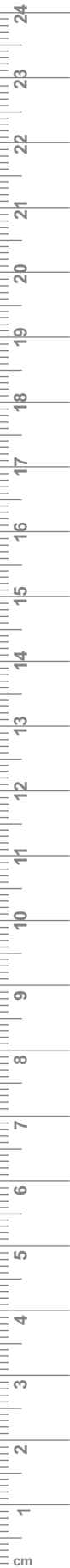
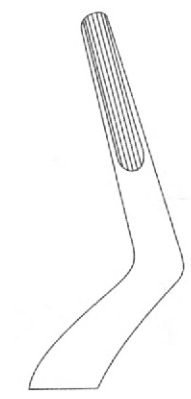



Fig. 51 M



DS-1140

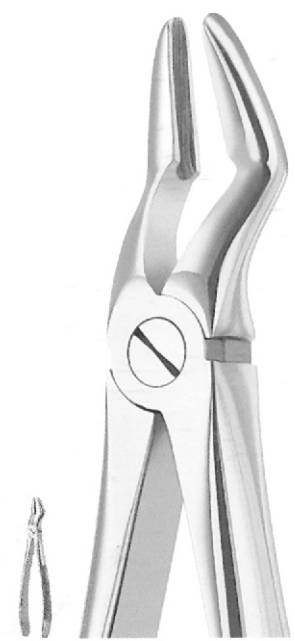
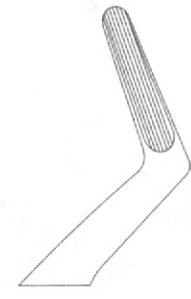

Fig. 52



DS-1141



Fig. 52 A

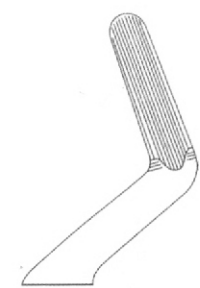

DS-1142



Fig. 53

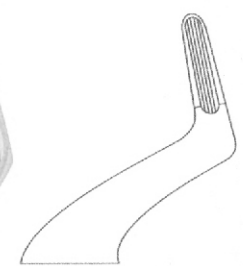

DS-1143

EXTRACTING FORCEPS ENGLISH



Fig. 55

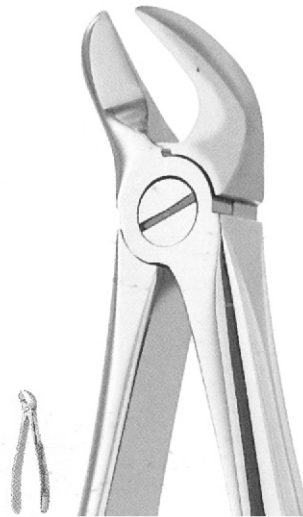
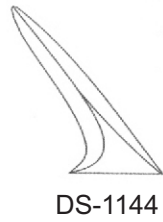
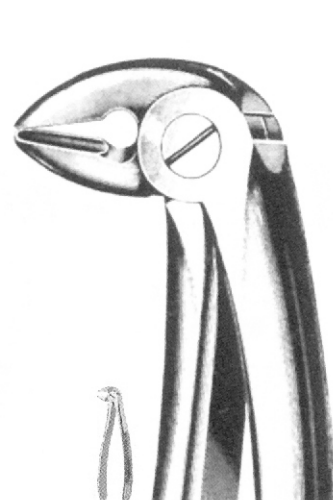
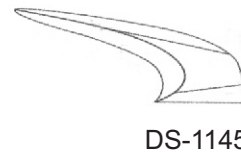
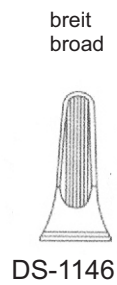

Fig. 56



BUSCH
Fig. 59



BUSCH
Fig. 60

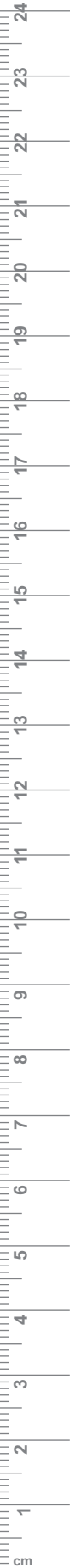

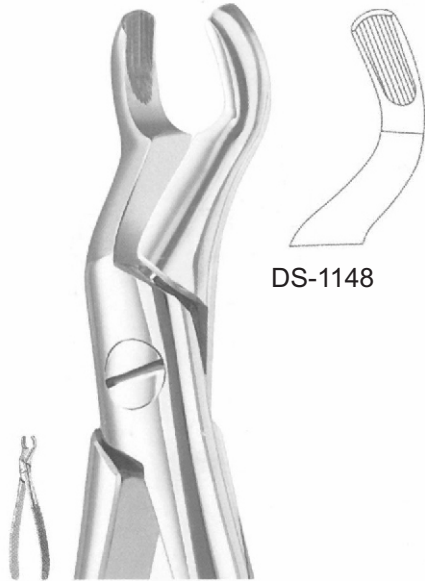

DS-1148

Fig. 67

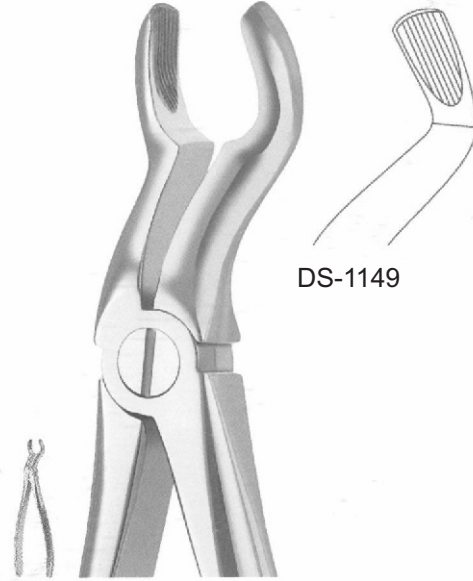

DS-1149

Fig. 67 A

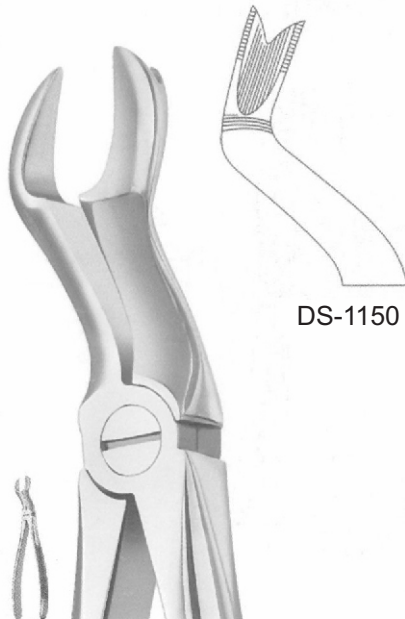

DS-1150

Fig. 67 LX

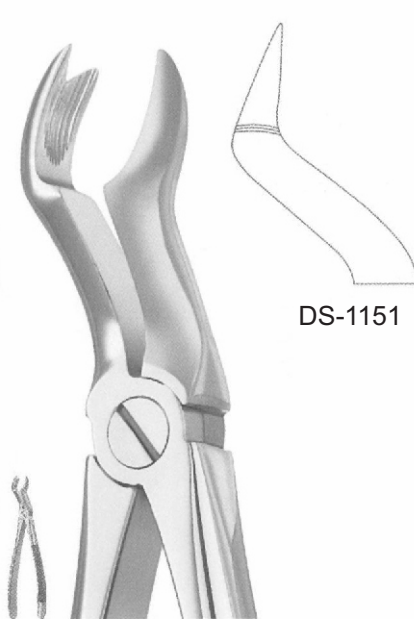

DS-1151

Fig. 67 RX

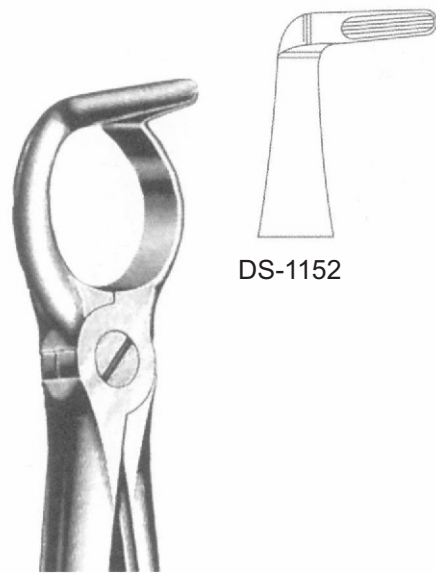

DS-1152

RYDING
Fig. 68

Extracting forceps, English pattern — EN
 Zahnzangen, Englische Form — DE
 Daviers, forme anglaise — ES



Fig. 73



DS-1153



Fig. 74

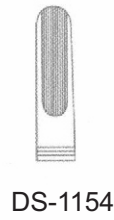

DS-1154

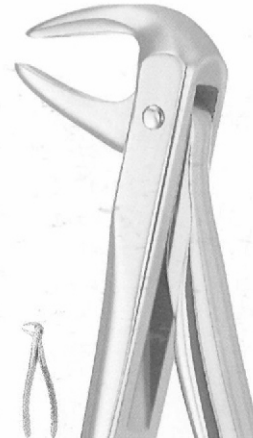
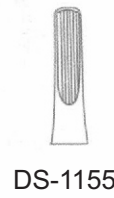

Fig. 74 M



DS-1155

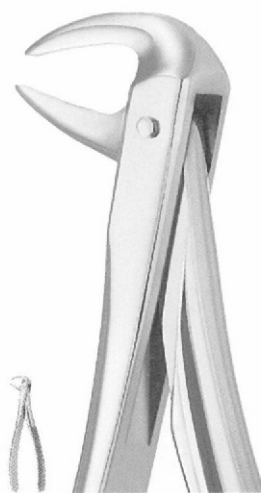
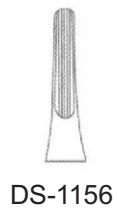

Fig. 74N



DS-1156



Fig. 75

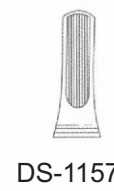

DS-1157

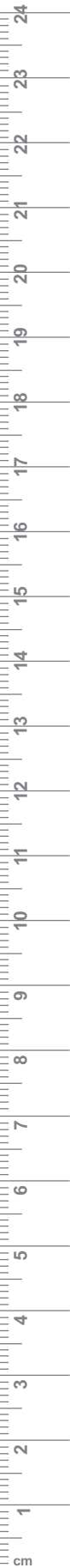



DS-1158

LAWRENCEDS-READ
Fig. 76



DS-1159

LAWRENCEDS-READ
Fig. 76 N



Fig. 79



Fig. 79 A



Fig. 86 A



Fig. 86 B



Fig. 86 C





Fig. 87

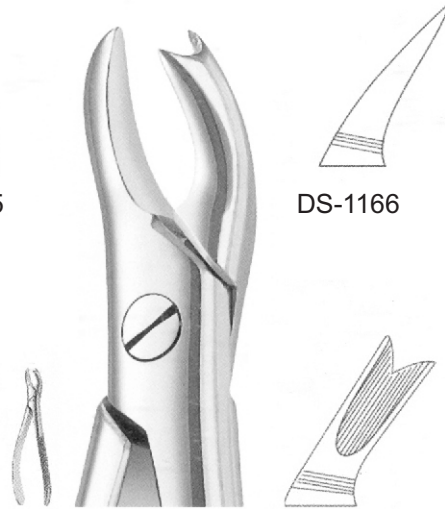

Fig. 89

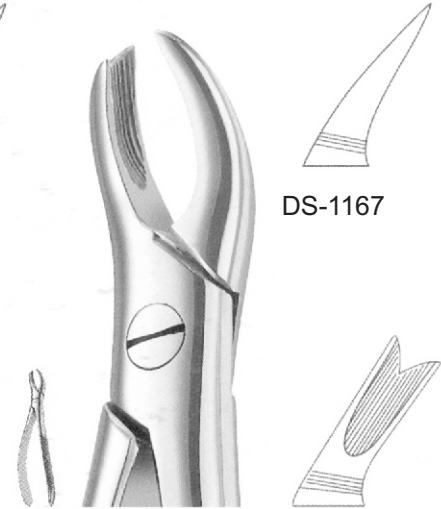

Fig. 90



Fig. 94

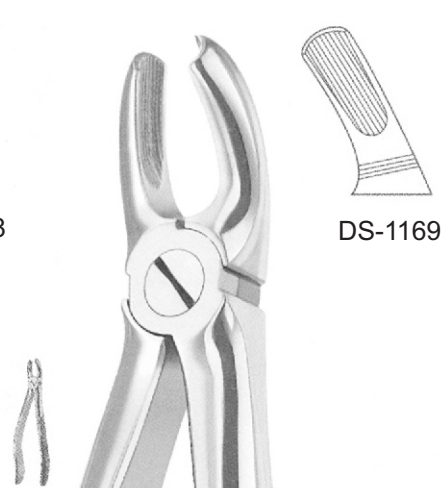

Fig. 95



WOOD
Fig. 99

Extracting forceps, English pattern ●— EN
 Zahnzangen, Englische Form ●— DE
 Daviers, forme anglaise ●— ES

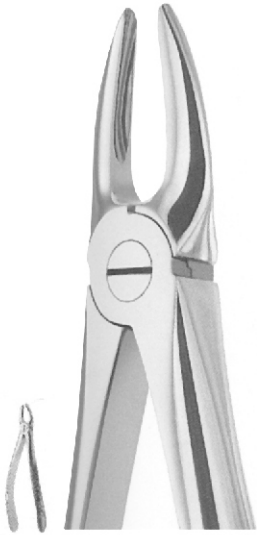
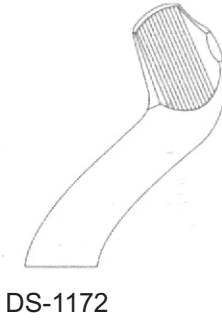

Fig. 113
DS-1171



OGDEN FELSCH
Fig. 121



DS-1172



GUY
Fig. 136
DS-1173

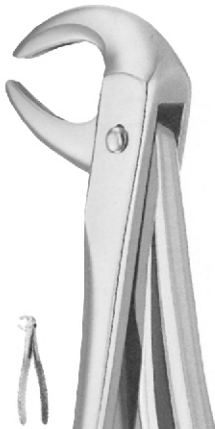

GUY
Fig. 137
DS-1174



Fig. 160
DS-1175



Fig. 162
DS-1176

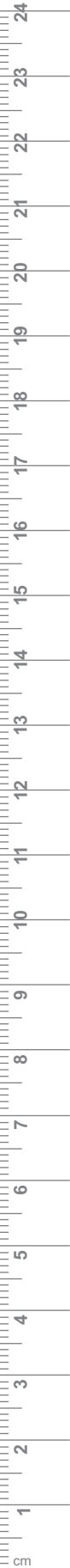



DS-1177
Fig. 233



DS-1178



DS-1179
Fig. 235



EXTRACTING FORCEPS ENGLISH



MEAD
Fig. MD 1



DS-1180

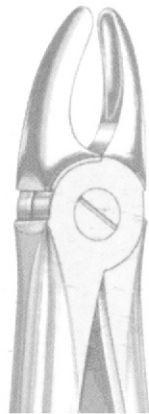

MEAD
Fig. MD 2



DS-1181



MEAD
Fig. MD 3



DS-1182



MEAD
Fig. MD 4



DS-1183

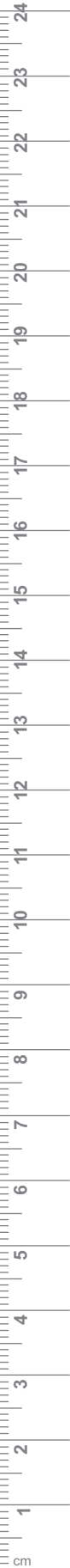

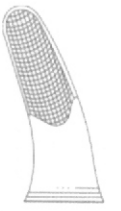

DS-1184

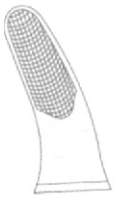
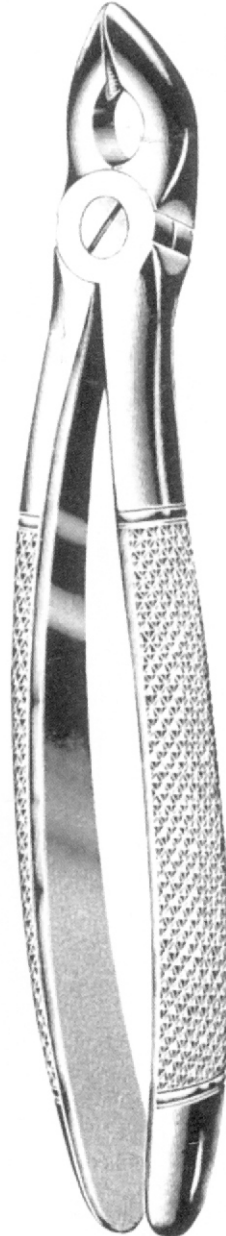

DS-1185

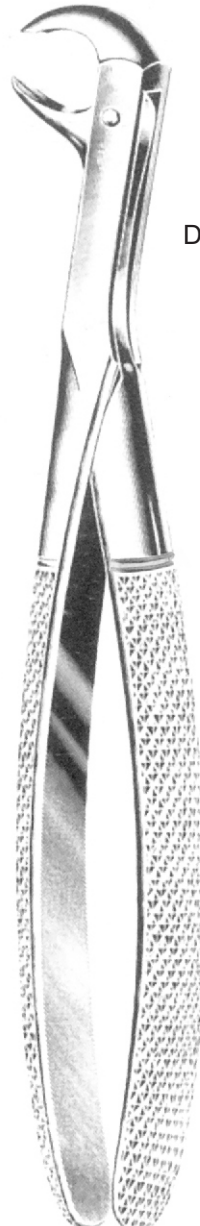

DS-1186

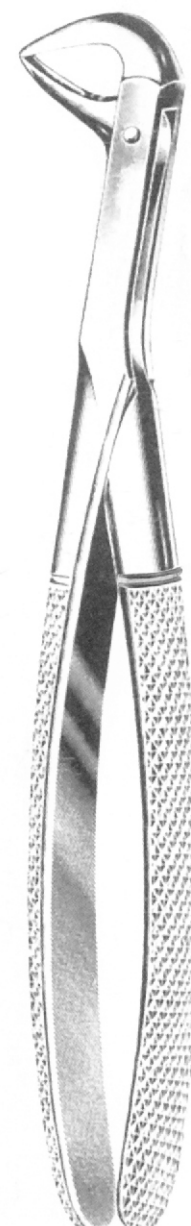

DS-1187

COHEN

COHEN

STIKSA

STIKSA

EXTRACTING FORCEPS ENGLISH

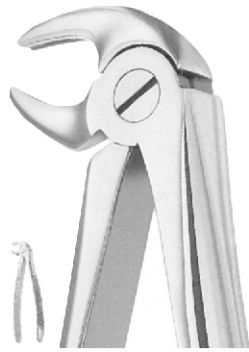

Fig. 13 S

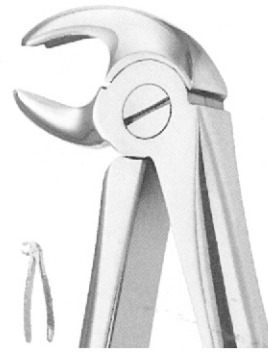

Fig. 22 S



Fig. 29 S



Fig. 30 S



Fig. 33 S

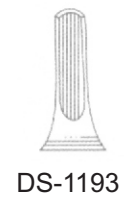
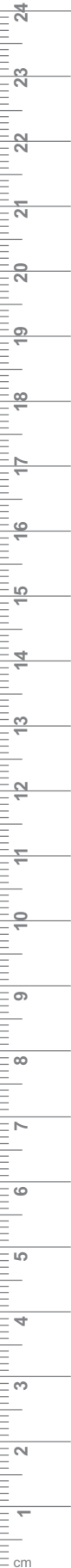

Fig. 37



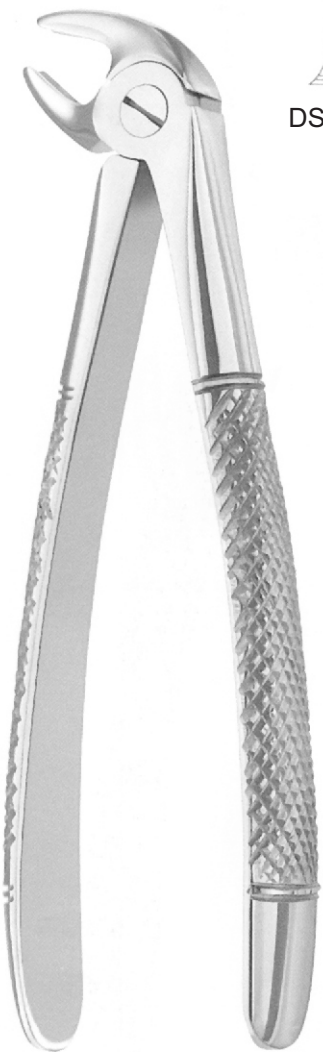

Fig. 38



DS-1194



Fig. 39



DS-1195

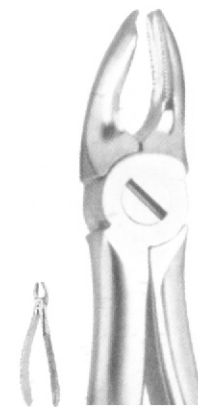

Fig. 39 A



DS-1196



Fig. 39 L



DS-1197



Fig. 39 R



DS-1198

Extracting forceps, English pattern ●— EN
 Zahnzangen, Englische Form ●— DE
 Daviers, forme anglaise ●— ES



DS-1199

Fig. 40



DS-1200

Fig. 51 S



DS-1201
 LAWRENCE'S-READ
 Fig. 76 S



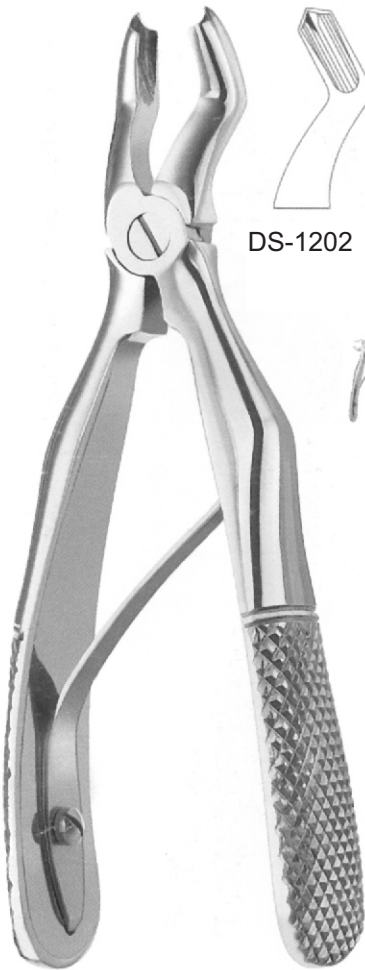

KLEIN
Fig. 3



DS-1202



Fig. 5



DS-1203



Fig. 6



DS-1204



Fig. 7

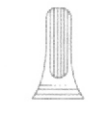

DS-1205

EXTRACTING FORCEPS ENGLISH



DS-1206

KLEIN
Fig. 137



DS-1207

KLEIN
Fig. 139



DS-1208

KLEIN
Fig. 51 S





Denis
Surgical

52

- EN** Root Elevators
- DE** Wurzelheber
- ES** Elevadores á racines

Page 40 to 54

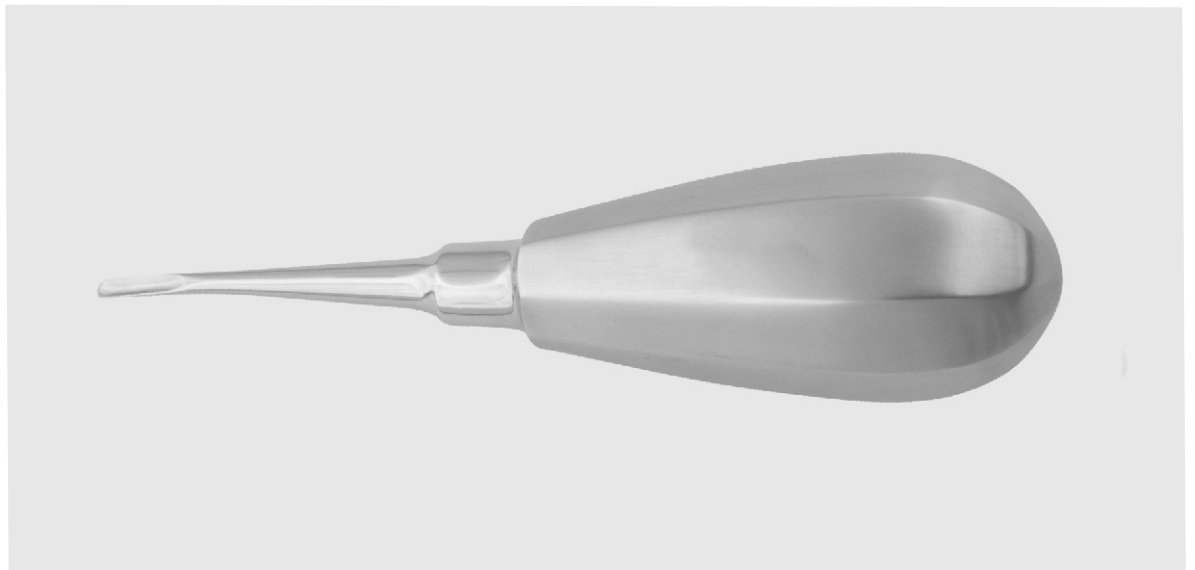

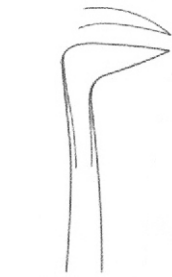

DS-1251
Fig. 1 L



DS-1252
Fig. 1 R



SALDIN
DS-1253
Fig. 2



SELDIN
DS-1254
Fig. 3

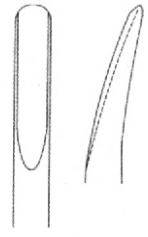

CRYER
DS-1255
Fig. 3 A



SELDIN
DS-1256
Fig. 4 L



SELDIN
DS-1257
Fig. 4 R



CRANE
(COGSWELL)
DS-1258
Fig. 6

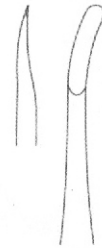

MILLER
DS-1259
Fig. 8

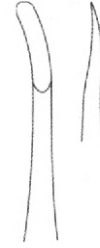

MILLER
DS-1260
Fig. 9



MILLER (Apexo)
DS-1261
Fig. 10



MILLER (Apexo)
DS-1262
Fig. 11

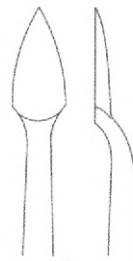

CRYER
DS-1263
Fig. 12

Root Elevators ● EN
 Wurzelauflzüge ● DE
 Elevadores De Raíz ● ES



CRYER
DS-1264
Fig 27



CRYER
DS-1265
Fig. 28



CRYER
DS-1266
Fig.27 S



CRYER
DS-1267
Fig. 28 S

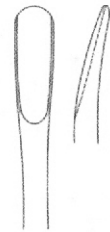

SELDIN
DS-1268
Fig. 34

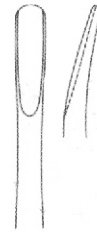

SELDIN
DS-1269
Fig. 34 S



CRYER
DS-1270
Fig. 39



CRYER
DS-1271
Fig. 40



FLOHR
DS-1272
Fig. 46



DS-1273
Fig. 50



DS-1274
Fig. 51

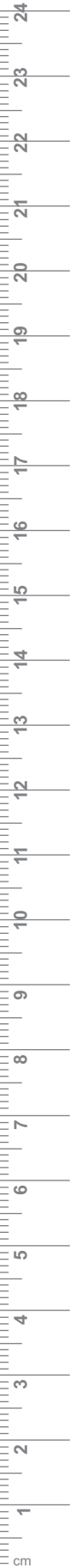

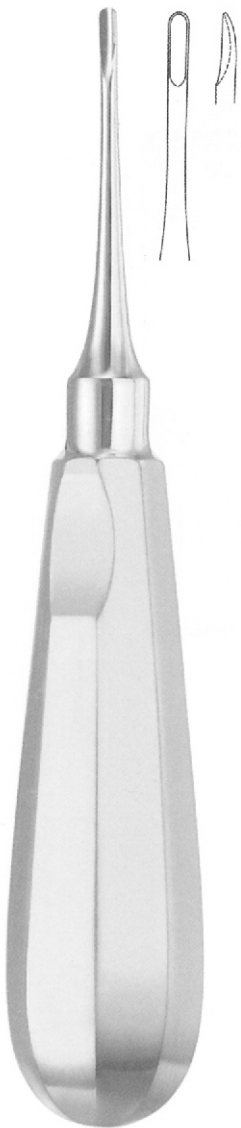

APICAL (Apexo)
 DS-1275
 Fig. 301

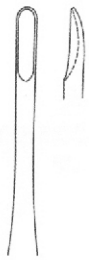

DS-1276
 Fig. 304

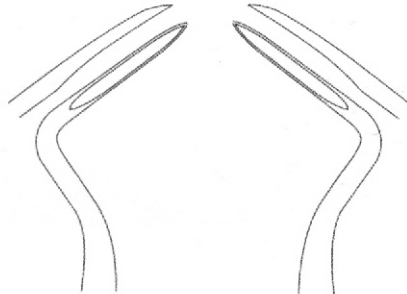

DS-1277
 Fig. 302

FLOHR
 DS-1278
 Fig. 303



COLEMAN



DS-1279
 Fig. 1

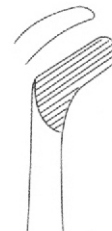

DS-1280
 Fig. 2 L

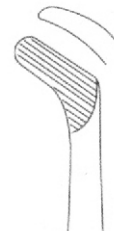

DS-1281
 Fig. 3 R

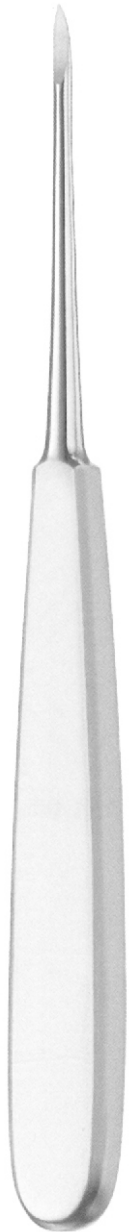

WARWICK JAMES
 DS-1282
 16 cm/6 1/4"



DS-1283
 Fig. 2 L



DS-1284
 Fig. 3 L



KOPP



DS-1285
 Fig. 1



DS-1286
 Fig. 2



DS-1287
 Fig. 3



DS-1288
 Fig. 4

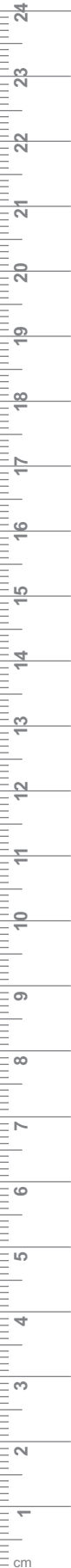



KOPP



DS-1289
Fig. 1



DS-1290
Fig. 2



DS-1293
Fig. 1



DS-1291
Fig. 3



DS-1292
Fig. 4



DS-1294
Fig. 2



DS-1295
Fig. 3

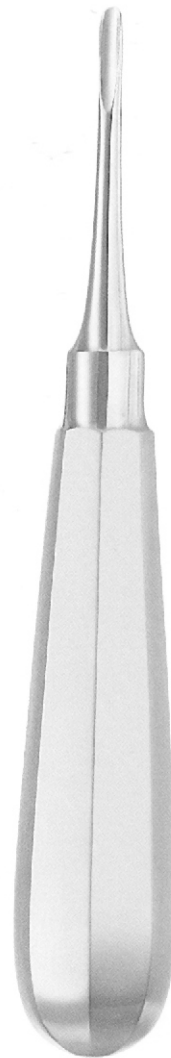

FLOHR



FRIEDMAN
 DS-1296
 Fig 1



DS-1297
 Fig. 2 L



DS-1298
 Fig. 3 R



HYLIN
 DS-1299
 Fig. 1

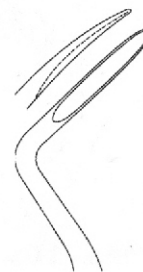

DS-1301
 Fig. 3 L

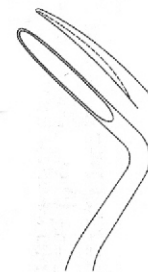

DS-1302
 Fig. 4 R

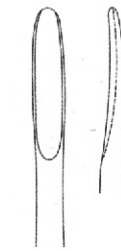

DS-1300
 Fig. 2

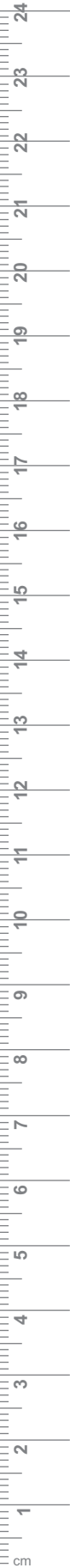



DS-1303
Fig.0

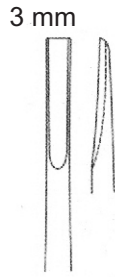

BEIN
DS-1304
Fig. 1

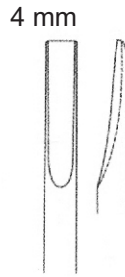

DS-1305
Fig. 2



DS-1306
Fig. 0



BEIN
DS-1307
Fig. 1



DS-1308
Fig. 2



DS-1309
Fig. 0



BEIN
DS-1310
Fig. 1



DS-1311
Fig. 2

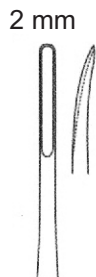

DS-1312
Fig. 0 A



BEIN
DS-1313
Fig. 1 A

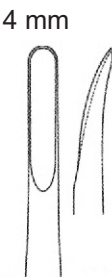

DS-1314
Fig.2 A



DS-1315
Fig.0 A



BEIN
DS-1316
Fig. 1 A

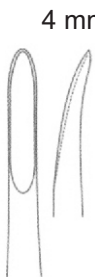

DS-1317
Fig. 2 A

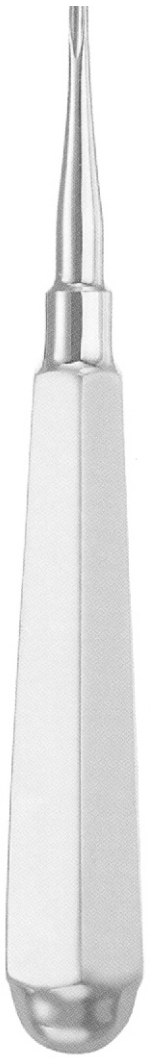
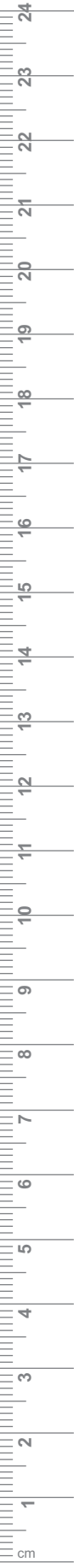

COUPLAND

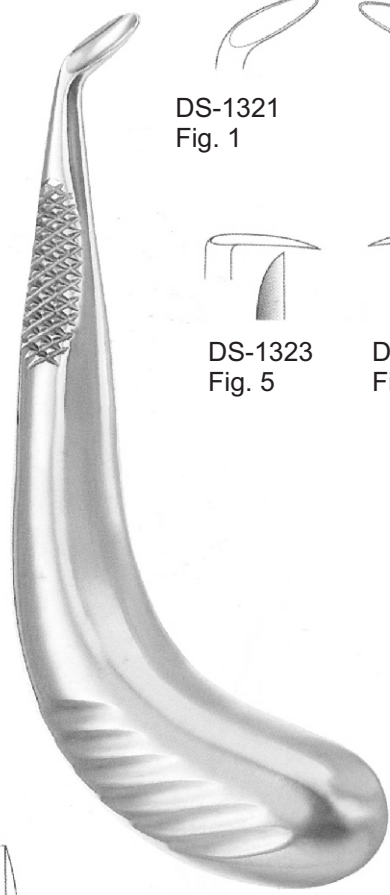
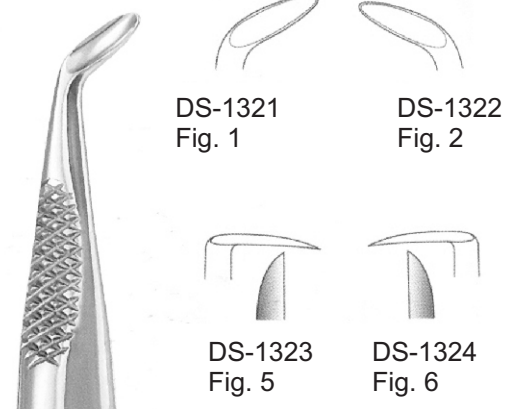
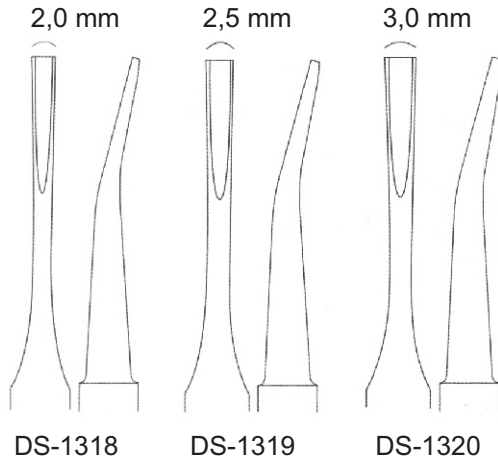

LOOS

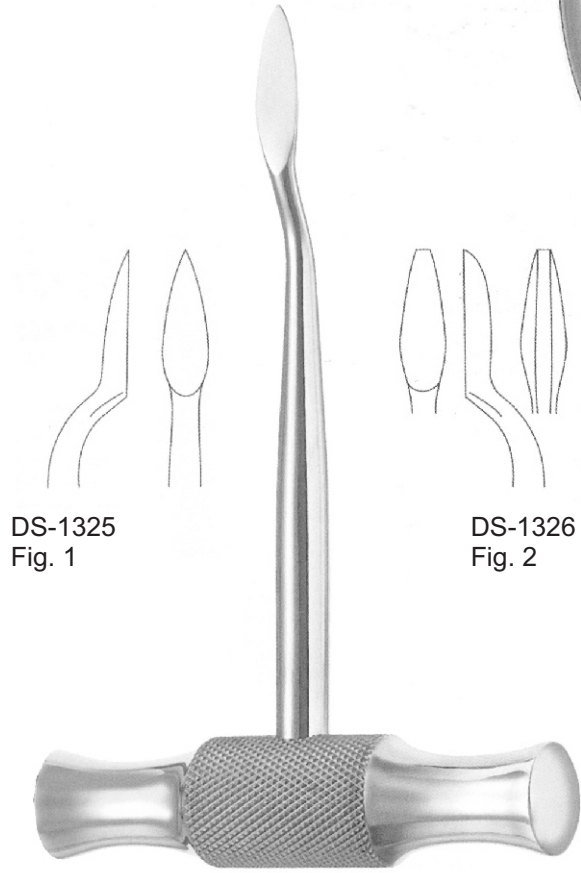

LECLUSE

DS-1325 Fig. 1

DS-1326 Fig. 2



BARRY
11 cm/4 1/4"



DS-1327
Fig. 320 L



DS-1328
Fig. 321 R



DS-1329
Fig. 322



DS-1330
Fig. 323



DS-1331
Fig. 370



DS-1332
Fig. 371



Root Elevators ● EN
 Wurzelauflzüge ● DE
 Elevadores De Raíz ● ES



DS-1333
Fig. 1 L



DS-1334
Fig. 1 R



DS-1335
Fig. 11 L



DS-1336
Fig. 11 R



DS-1337
Fig. 12 L



DS-1338
Fig. 12 R



WINTER
11 cm/4 1/4"

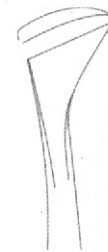

DS-1339
Fig. 13 L



DS-1340
Fig. 13 R



DS-1341
Fig. 14 L



DS-1342
Fig. 14 R

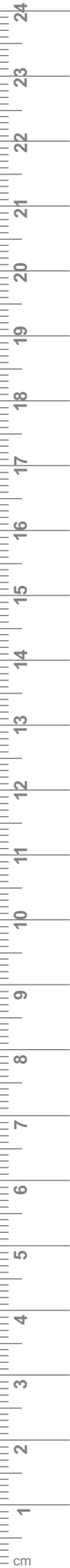

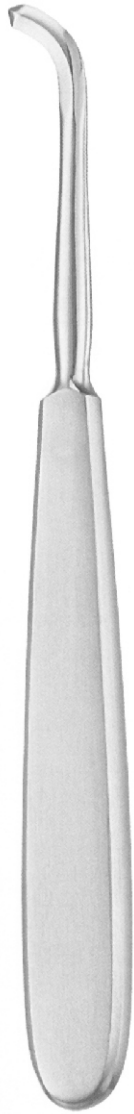

CHOMPRET



DS-1343
Fig. 1



DS-1344
Fig. 2



DS-1345
Fig. 3



DS-1346
Fig. 4

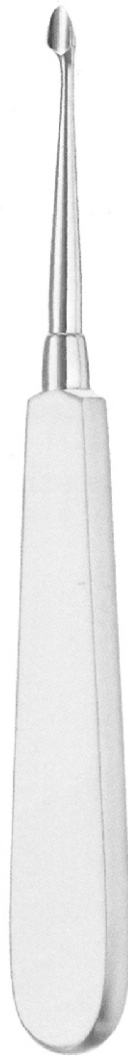

BERNARD



DS-1347
Fig. 0

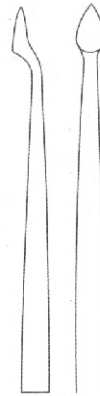

DS-1348
Fig. 1



DS-1349
Fig. 2

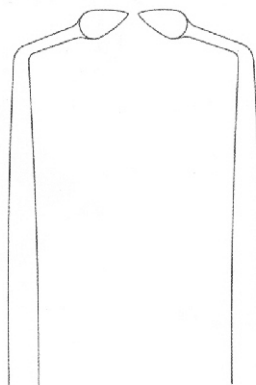

DS-1351
Fig. 7



DS-1352
Fig. 11

DS-1350
Fig. 6

Root Elevators ● EN
 Wurzelauflüge ● DE
 Elevadores De Raíz ● ES



BERNARD
Handle # A

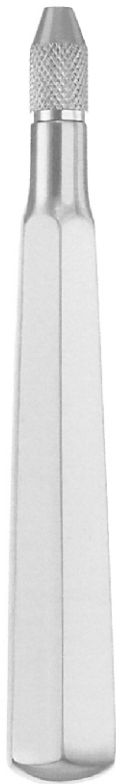

BERNARD
Handle # B



DS-1353
Fig. 1



DS-1354
Fig. 2



DS-1355
Fig. 3



DS-1356
Fig. 4



DS-1357
Fig. 5



DS-1358
Fig. 10

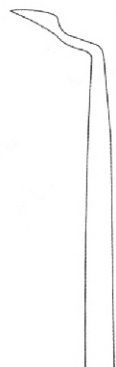

DS-1359
Fig. 8



DS-1360
Fig. 9

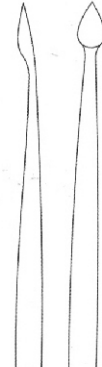

DS-1361
Fig. 11

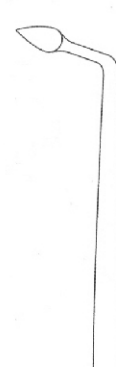

DS-1362
Fig. 7

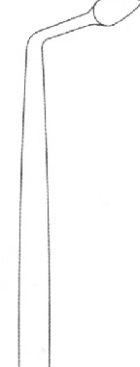

DS-1363
Fig. 6

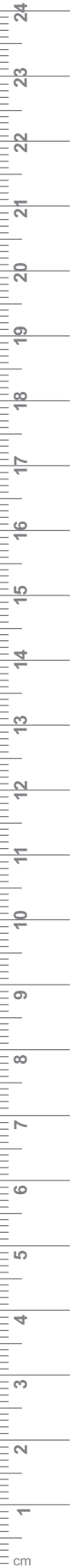

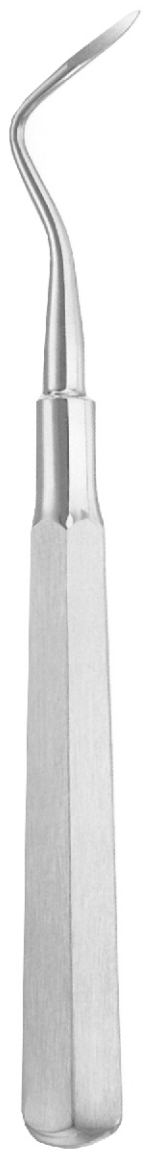

HEIDBRINK



DS-1366
Fig. 1



DS-1367
Fig. 2



DS-1368
Fig. 3



WEST (Apical)



DS-1369
Fig. 1

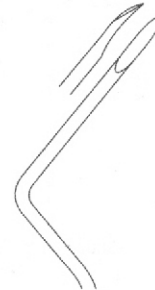

DS-1370
Fig. 2 R

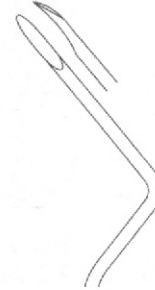

DS-1371
Fig. 3 L



RATZOW

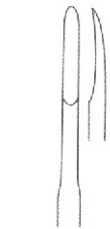

DS-1372
Fig. 1



DS-1373
Fig. 2



DS-1374
Fig. 3



HEIDBRINK

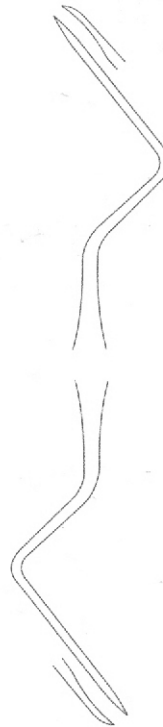

DS-1375
Fig. 1

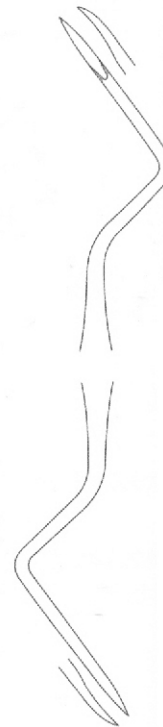

DS-1376
Fig. 2

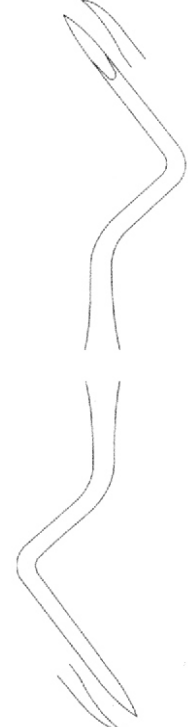

DS-1377
Fig. 23

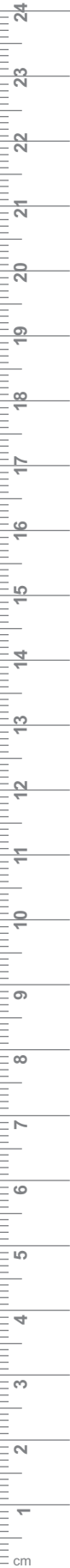

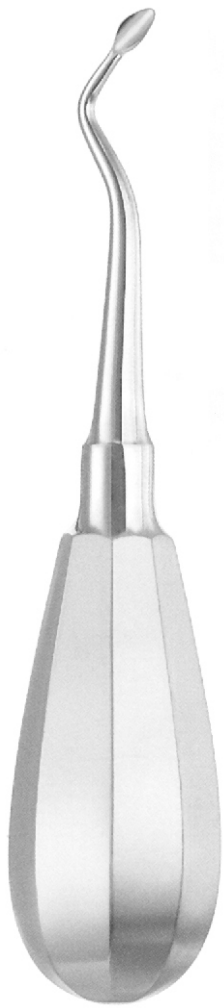

VIGNAL

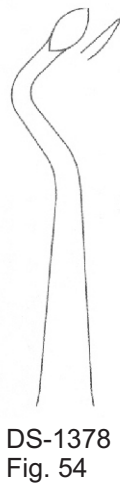

DS-1378
Fig. 54



DS-1379
Fig. 55

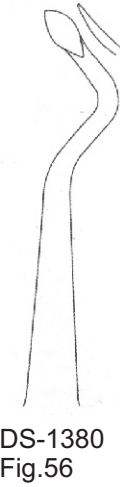

DS-1380
Fig.56

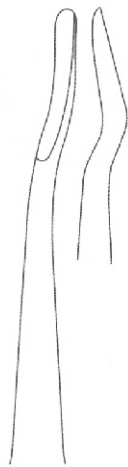

DS-1381
Fig.57



DS-1382
Fig. 69



DS-1383

4 mm



DS-1384

5 mm



DS-1385

6 mm



BARRY
21.5 cm/8 3/4"



Denis
Surgical

53

EN

Bone Files

DE

BoneDS-Dateien

ES

Archivos de huesos

Page 55 to 56

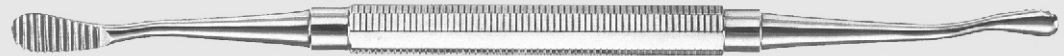

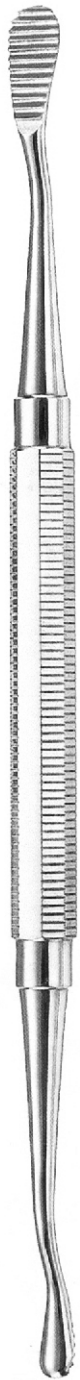

MILLERDS-COLBURN
18 cm/7"

downwards cutting

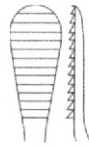

Fig. 1

DS-1401

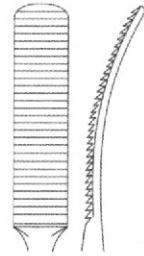
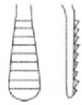

Fig. 2

DS-1402

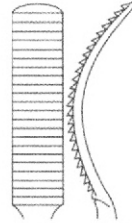
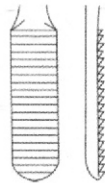

Fig. 3

DS-1403

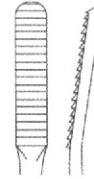
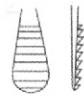

Fig. 4

DS-1404

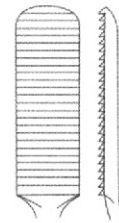
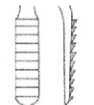

Fig. 5

DS-1405

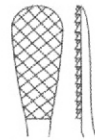
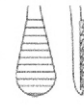

Fig. 1

DS-1406

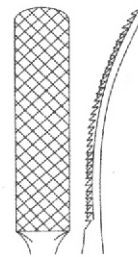

Fig. 2

DS-1407

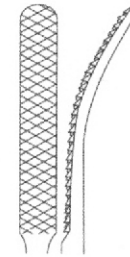
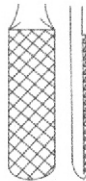

Fig. 3

DS-1408

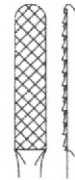
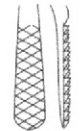
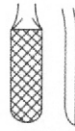

Fig. 4

DS-1409



cross cut



MILLERDS-COLBURN
18 cm/7"

Bone files — EN
 Knochenfeilen — DE
 Limes à os — ES

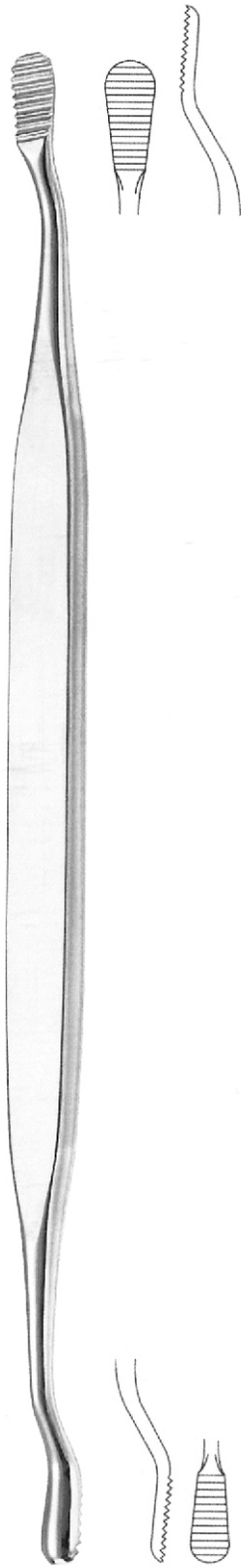

SELDIN
 DS-1410
 18 cm/7"
 Fig. 11

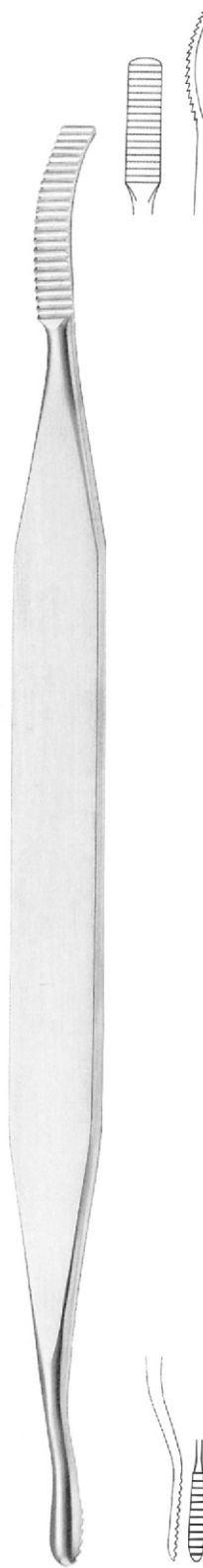

SELDIN
 DS-1411
 18 cm/7"
 Fig. 12

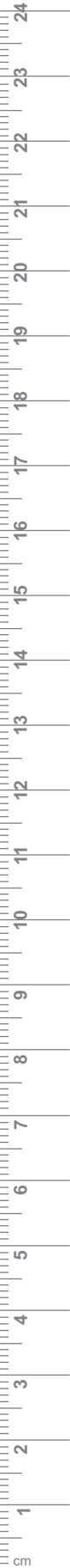



Denis
Suegical

54

EN

Dental Probes

DE

Zahnsonden

ES

Sondas dentales





3DS-6DS-8DS-11



Fig. 8
DS-1451

1DS-2DS-3DS-5DS-7DS-8DS-9DS-10 3DS-6DS-8DS-11



Fig. 10
DS-1452



Fig. 11
DS-1453

1DS-2DS-3DS-5DS-7DS-8DS-9DS-10 3DS-6DS-9DS-12



Fig. W
DS-1454
Williams



Mercury
DS-1455

1DS-2DS-3DS-5DS-7DS-8DS-9DS-10



Merrit A
DS-1456

1DS-2DS-3DS-5DS-7DS-8DS-9DS-10

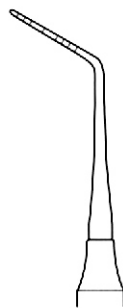

Merrit E
DS-1457

1DS-2DS-3DS-5DS-7DS-8DS-9DS-10



Goldman DS-Fox
DS-1458

3DS-6DS-8



Michigan
DS-1459

3DS-6DS-9DS-12



Fig. CPNG 12S
DS-1460
with ball

3.5DS-5.5DS-8.5DS-11.5

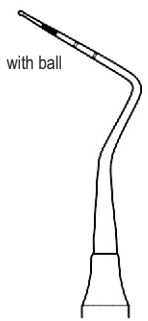

Fig. CPG 11.5 WHO
DS-1461
with ball

3DS-6DS-9DS-12



Fig. CPG 12
DS-1462

1DS-2DS-3DS-4DS-5DS-6DS-7DS-8DS-9DS-10DS-11DS-12DS-13DS-14DS-15



Fig. CP 15 UNC
DS-1463

2DS-4DS-6DS-8DS-10DS-12



Fig. CPNG 22
DS-1464

1DS-2DS-3DS-5DS-7DS-8DS-9DS-10

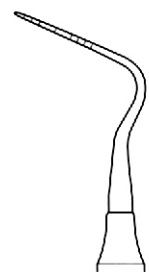



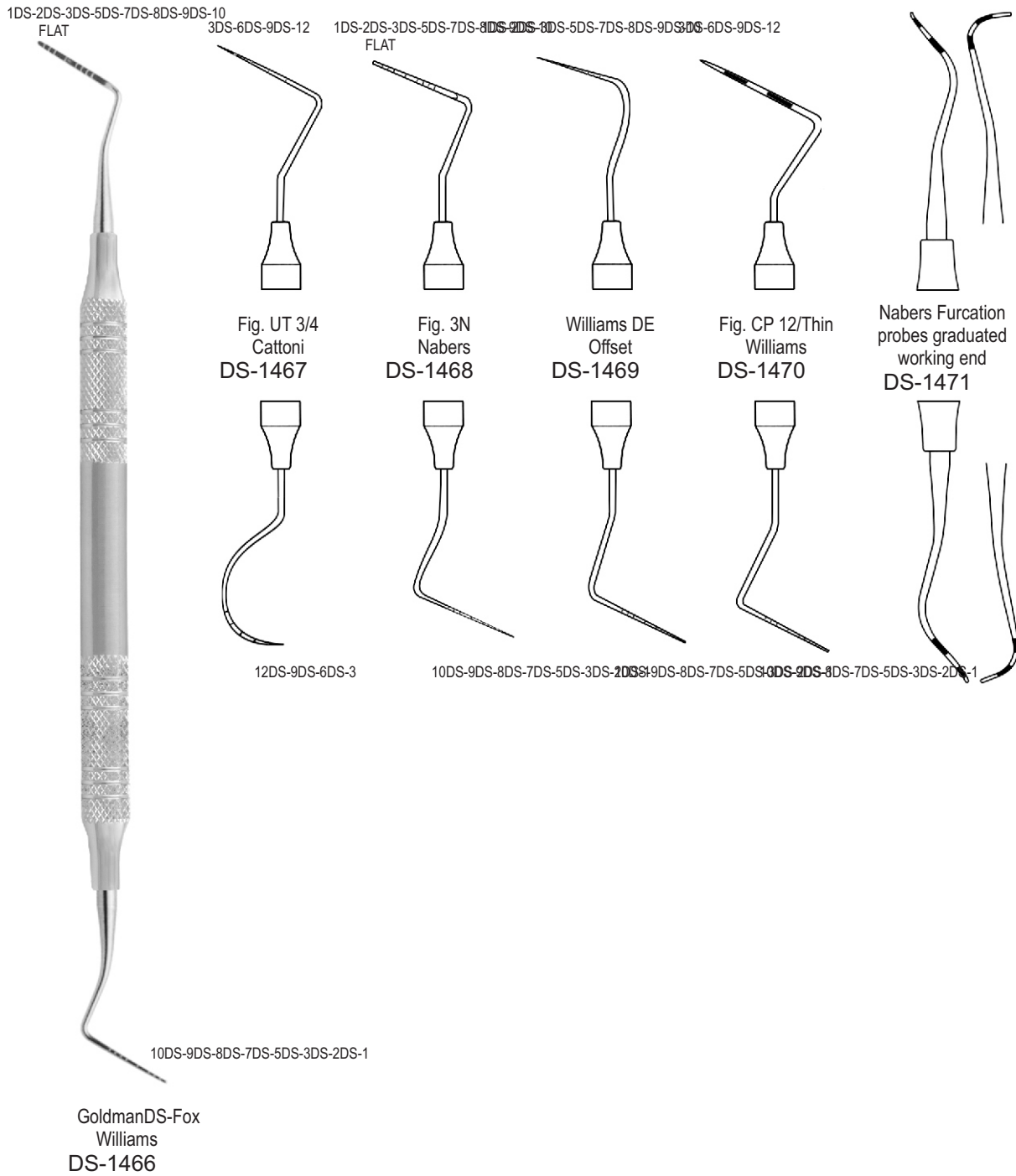

Fig. 26G
DS-1465

Probes DS- Single Ended  EN
 Sonden DS- Single Ended  DE
 Sondas DS- terminación simple  ES





Denis
Surgical

55

- EN** Enamel Instruments
- DE** EmailleDS-Instrumente
- ES** Instrumentos de esmalte

Page 59 to 62

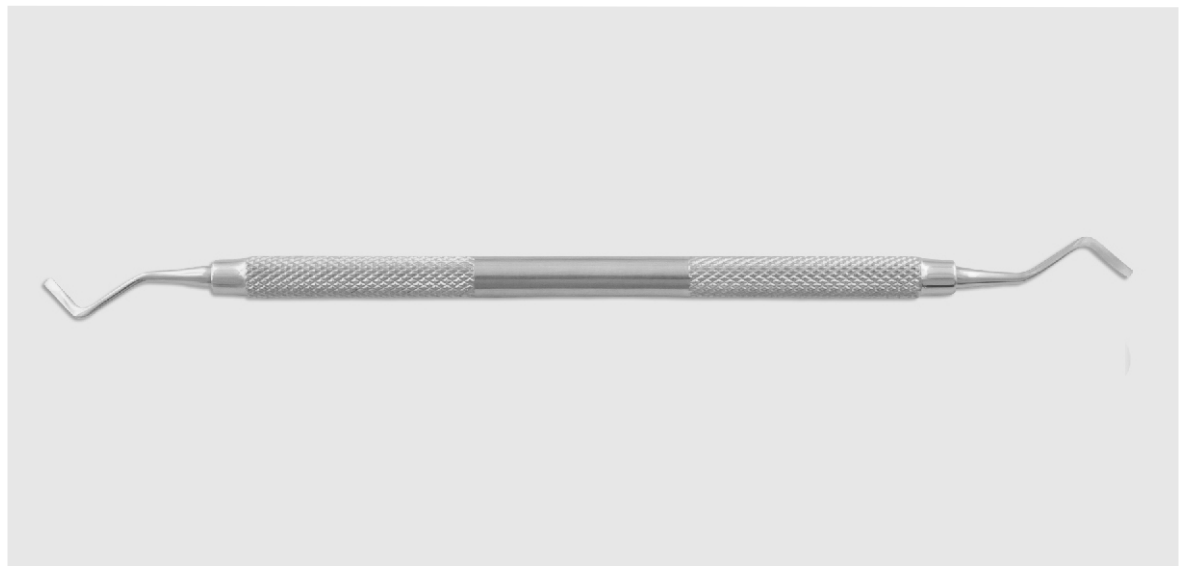

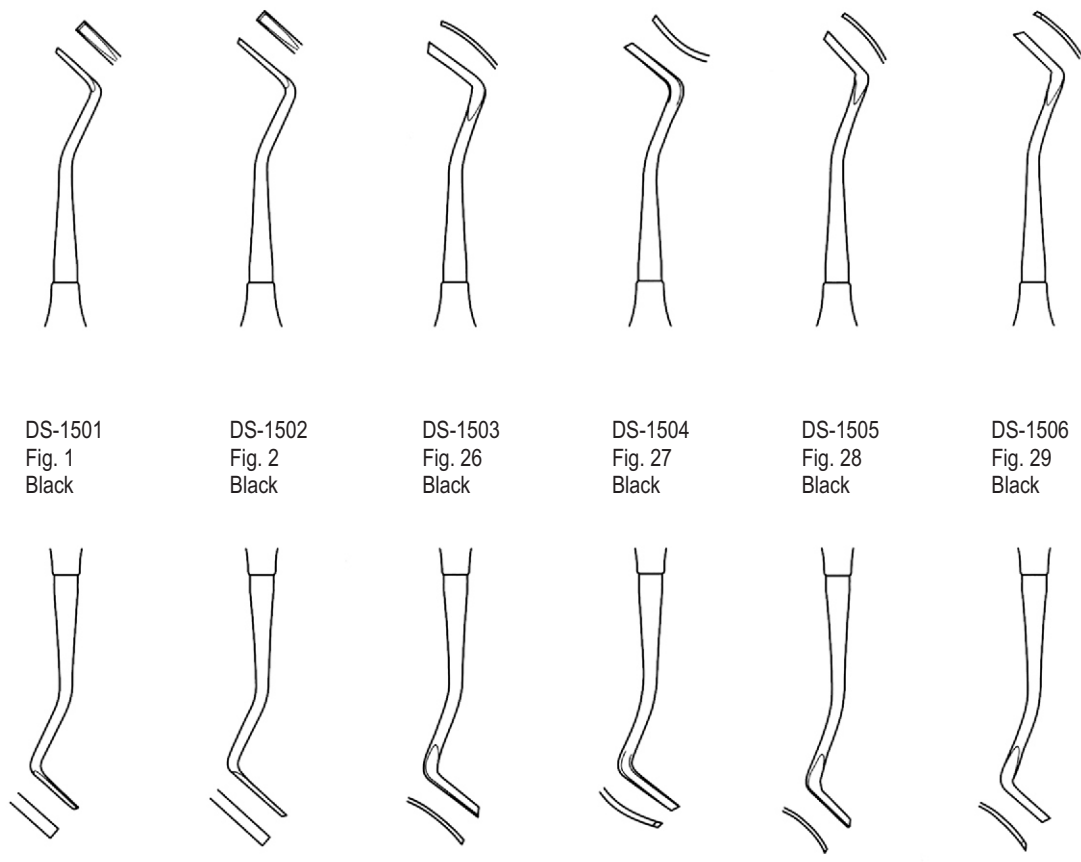

DS-1501
Fig. 1
Black

DS-1502
Fig. 2
Black

DS-1503
Fig. 26
Black

DS-1504
Fig. 27
Black

DS-1505
Fig. 28
Black

DS-1506
Fig. 29
Black

Chisels ● EN
 Meißel ● DE
 Cinceles ● ES



DS-1507
 Fig. 51/52
 Black



DS-1508
 Fig. 53/54
 Black



DS-1509
 Fig. 63/64
 Black



DS-1510
 Fig. 65/66
 Black



DS-1511
 Fig. 1/2
 Wedelstaedt



DS-1512
 Fig. 3/4
 Wedelstaedt



DS-1513
 Fig. 5/6
 Wedelstaedt

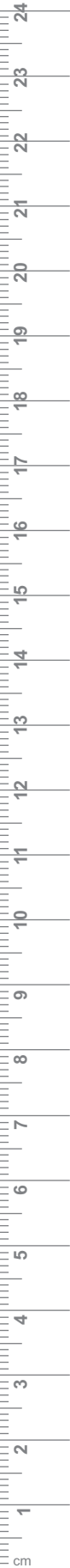



DS-1514
Fig. 8/9H



DS-1515
Fig. 13/14



DS-1516
Fig. 15/16



DS-1517
Fig. 17/18



DS-1518
Fig. 51/52



DS-1519
Fig. 53/54



DS-1520
Fig. 14/14
Off Angle



Chisels ● EN
 Meißel ● DE
 Cinceles ● ES



DS-1521
 Fig. 26
 Distal



DS-1522
 Fig. 27
 Mesial



DS-1523
 Fig. 28
 Distal



DS-1524
 Fig. 29
 Mesial



DS-1525
 Fig. 77/78
 Distal



DS-1526
 Mesial
 54DS-1142DS-00

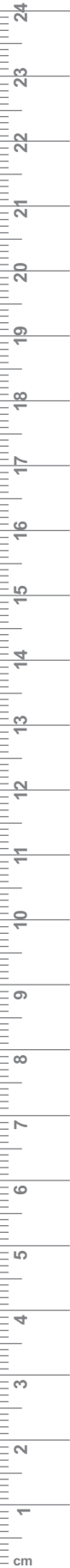



Denis
Surgical

56

EN

Dental Scalers

DE

Zahnsteinentferner

ES

Escaladores dentales

Page 63 to 78

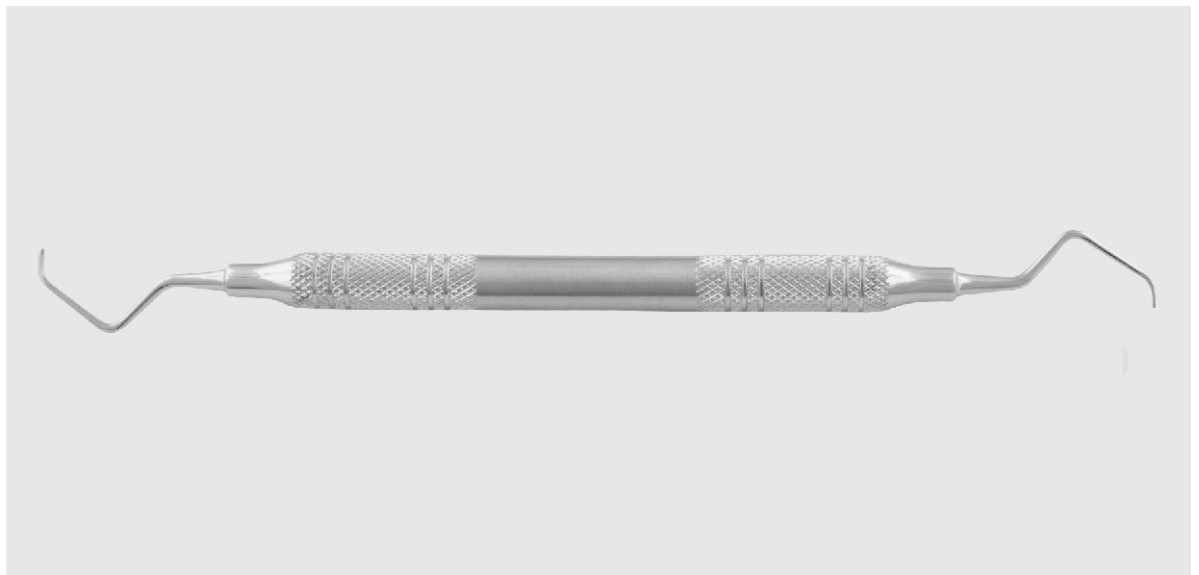



Fig. 3
700DS-140

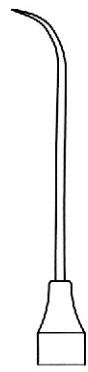

Fig. 3A
DS-1551

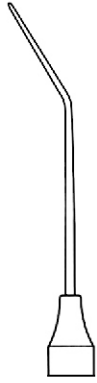

Fig. 5
DS-1552

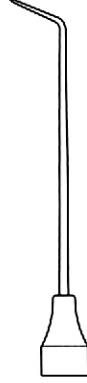

Fig. 6
DS-1553
6.5 mm

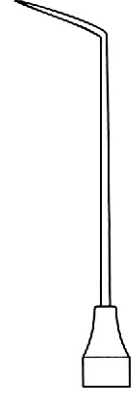

Fig. 6A
DS-1554
12 mm

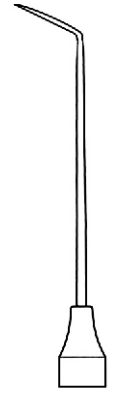

Fig. 6L
DS-1555
9 mm

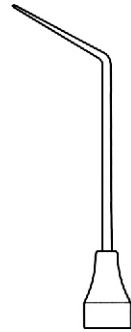

Fig. 6XL
DS-1556
12.5 mm

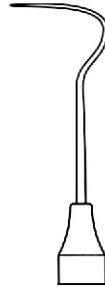

Fig. 8
DS-1557



Fig. 8A
DS-1558



Fig. 9
DS-1559



Fig. 10
DS-1560



Fig. 12
DS-1561



Fig. 17
DS-1562



Fig. 17A
DS-1563

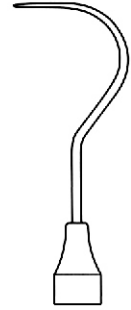

Fig. 23
DS-1564
Shepherd's Hook

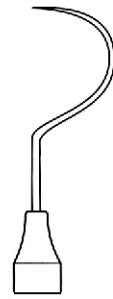

Fig. 54
DS-1565

Explorers DS- Double Ended — EN
 Forscher DS- Doppelt beendete — DE
 Exploradores DS- Doble final — ES



Fig. UT 1/2
 DS-1566



Fig. UT 2/2
 DS-1567



Fig. 3CH/3CH
 DS-1568



Fig. 6/3
 DS-1569



Fig. 16/3
 DS-1570



Fig. 2
 DS-1571

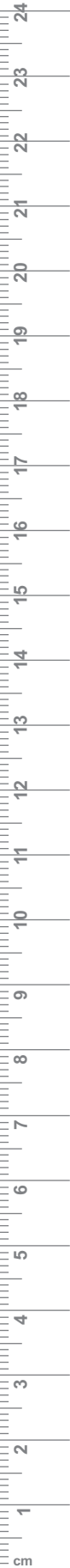
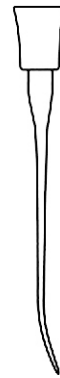
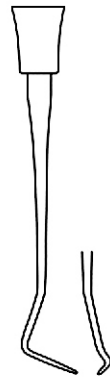



Fig. 23/17
DS-1572



Fig. 2A
DS-1573



Fig. 3
DS-1574



Fig. 1N
DS-1575
Nabers



Fig. 2N
DS-1576
Nabers



Fig. 5/6
DS-1577



Explorers DS- Double Ended — EN
 Forscher DS- Doppelt beendete — DE
 Exploradores DS- Doble final — ES

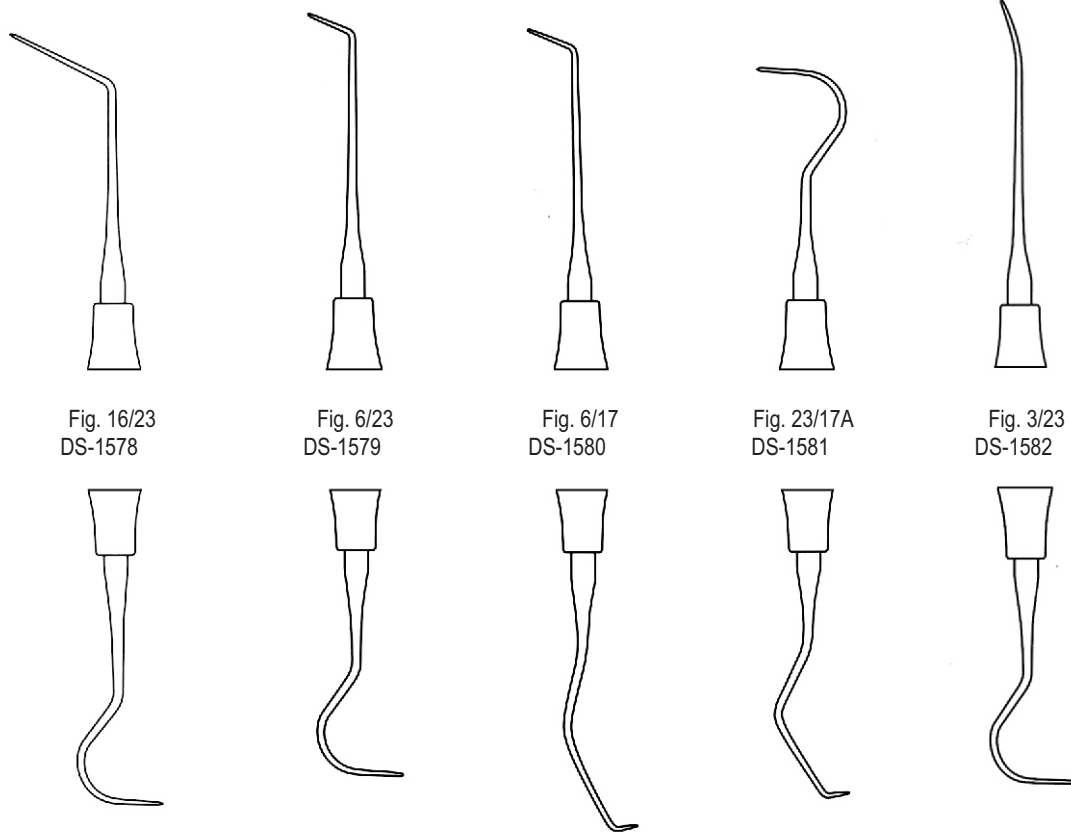

Fig. 16/23
DS-1578

Fig. 6/23
DS-1579

Fig. 6/17
DS-1580

Fig. 23/17A
DS-1581

Fig. 3/23
DS-1582





DS-1583
Fig. 1/2



DS-1584
Fig. 3/4



DS-1585
Fig. 5/6



DS-1586
Fig. 7/8



- Gracey Curettes ● — EN
- Gracey Küretten ● — DE
- Gracey Curettes ● — ES



DS-1587
Fig. 9/10



DS-1588
Fig. 11/12



DS-1589
Fig. 13/14



DS-1590
Fig. 15/16

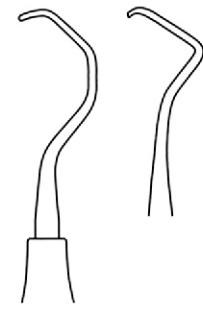

DS-1591
Fig. 17/18

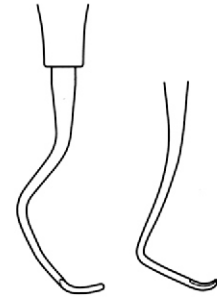



Langer
DS-1592
Fig. 1/2

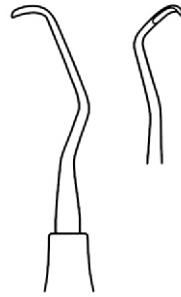

Langer
DS-1593
Fig. 3/4



Langer
DS-1594
Fig. 5/6



Langer
DS-1595
Fig. 17/18



Universal curettes are designed for easy adaptation on all tooth surfaces (thus the name "universal").

The blade of a universal curette has a round toe and back, and two cutting edges for scaling, making it an efficient design for scaling the entire mouth.

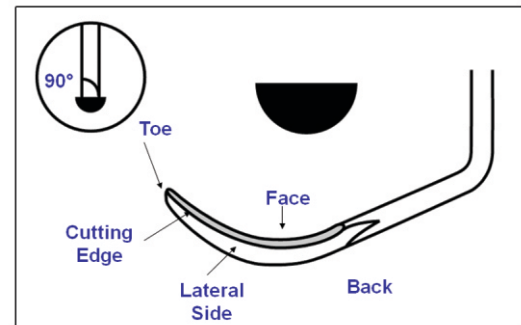

Universal Curettes ● EN
 Universalküretten ● DE
 Curetas universales ● ES



Columbia
DS-1596
Fig. 13/14



Columbia
DS-1597
Fig. 2R/2L



Columbia
DS-1598
Fig. 4R/4L



DS-1599
Fig. Gx4



Barnhart
DS-1600
Fig. 1/2



Barnhart
DS-1601
Fig. 5/6

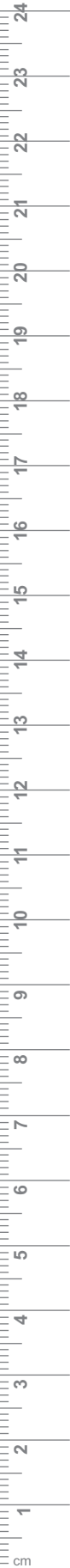

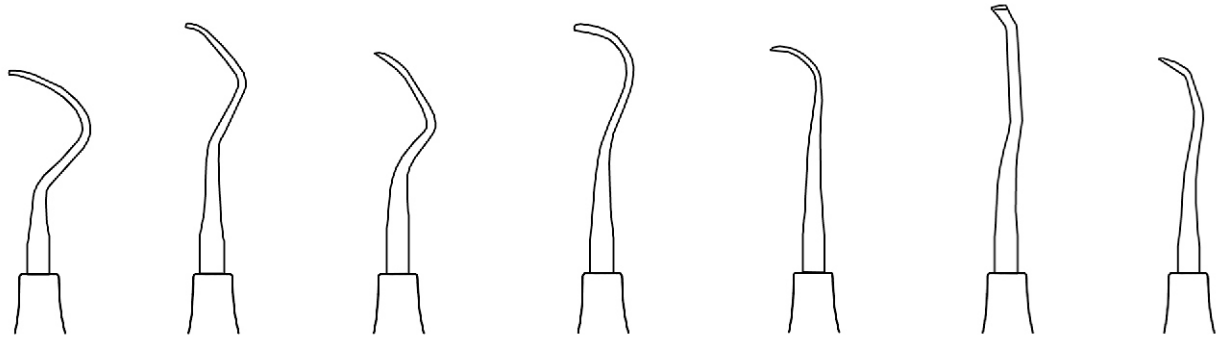

DS-1602 Fig. Me1	DS-1603 Rule [23DS-24] Fig. 3/4	DS-1604 Fig. IU 13/14 Indiana University	DS-1605 Fig. IU 17/18 Indiana University	DS-1606 Fig. 7/8 YoungerDS-Good	DS-1607 Fig. 1/2 Bunting	DS-1608 Fig. 5/6 Bunting
---------------------	---------------------------------------	--	--	---------------------------------------	--------------------------------	--------------------------------

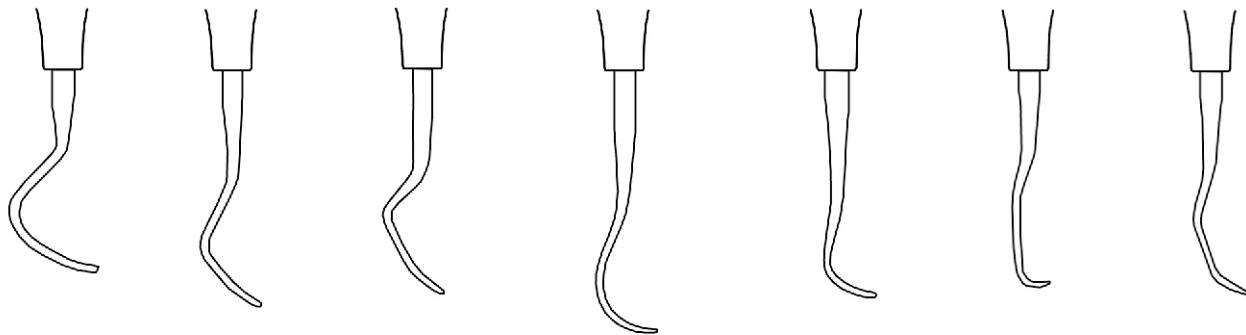

Universal Curettes ● EN
 Universalküretten ● DE
 Curetas universales ● ES

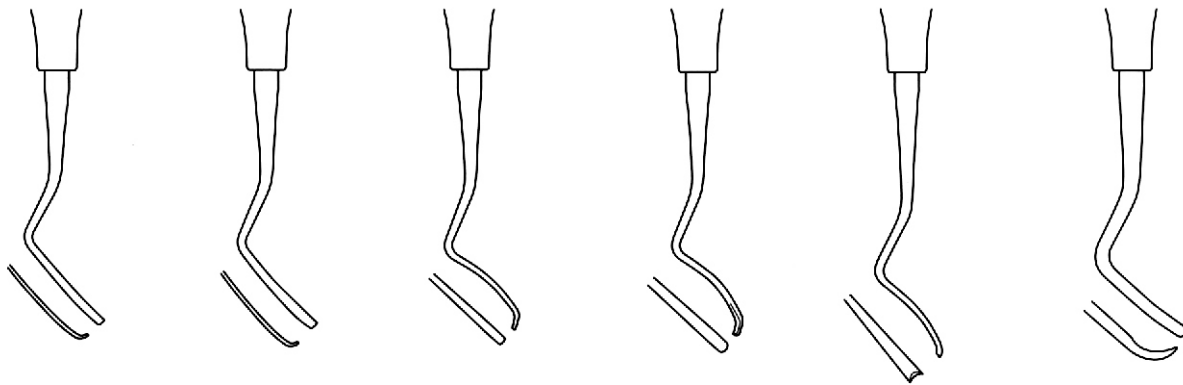
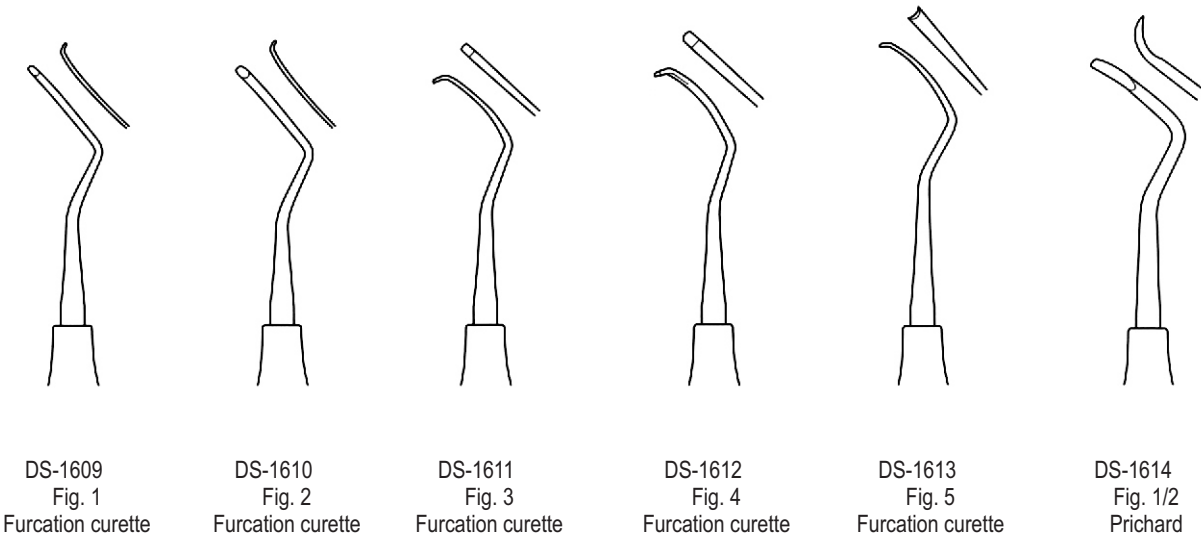

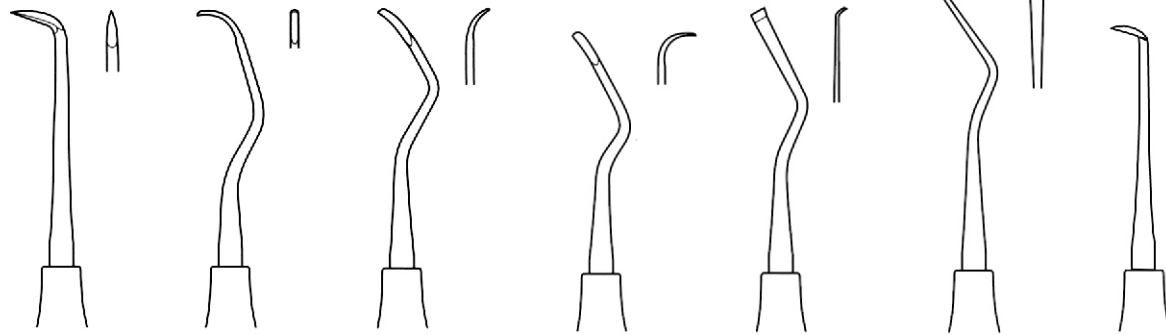

DS-1615 GoldmanDS-Fox Fig. 1 DS-1616 GoldmanDS-Fox Fig. 2 DS-1617 GoldmanDS-Fox Fig. 3 DS-1618 GoldmanDS-Fox Fig. 4 DS-1619 GoldmanDS-Fox Fig. 5 DS-1620 GoldmanDS-Fox Fig. 6 DS-1621 GoldmanDS-Fox Fig. 21

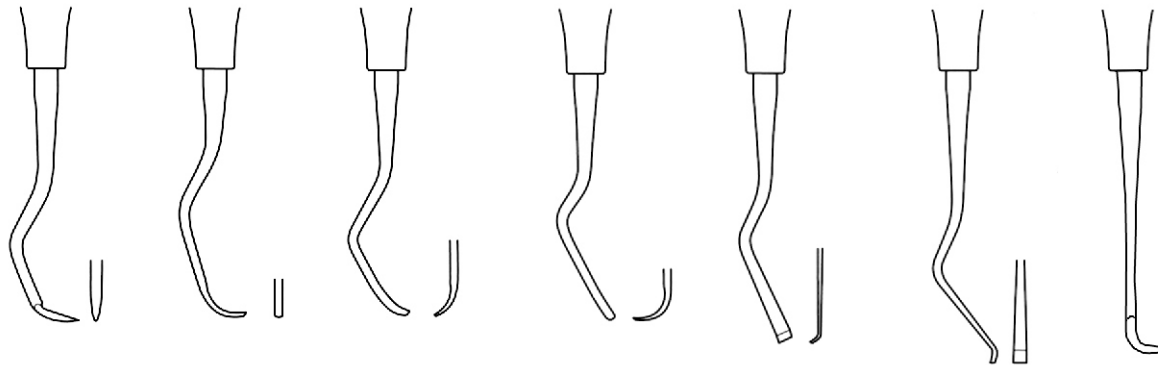

Scalers / Curettes ●— EN
 Scaler / Küretten ●— DE
 Scalers / Curettes ●— ES

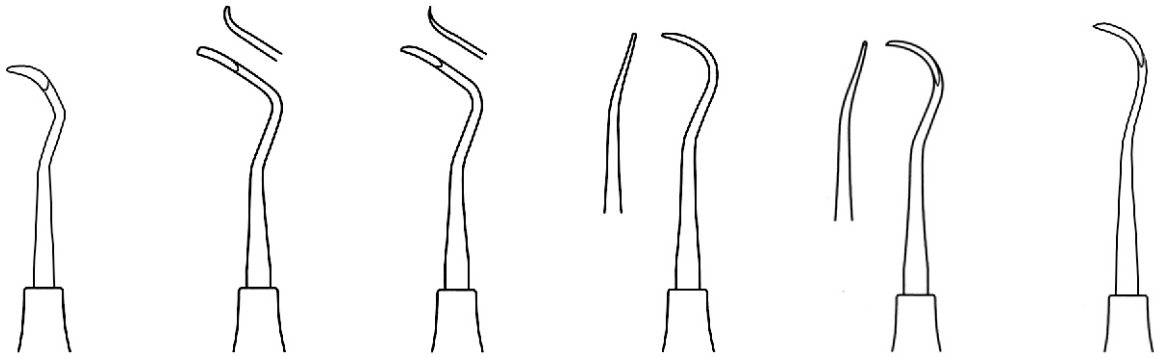

DS-1622
 McCall
 Fig. 11/12

DS-1623
 McCall
 Fig. 13S/14S

DS-1624
 McCall
 Fig. 13SM/14

DS-1625
 McCall
 Fig. 17/18

DS-1626
 McCall
 Fig. 17S/18S

DS-1627
 McCall
 Fig. 19/20

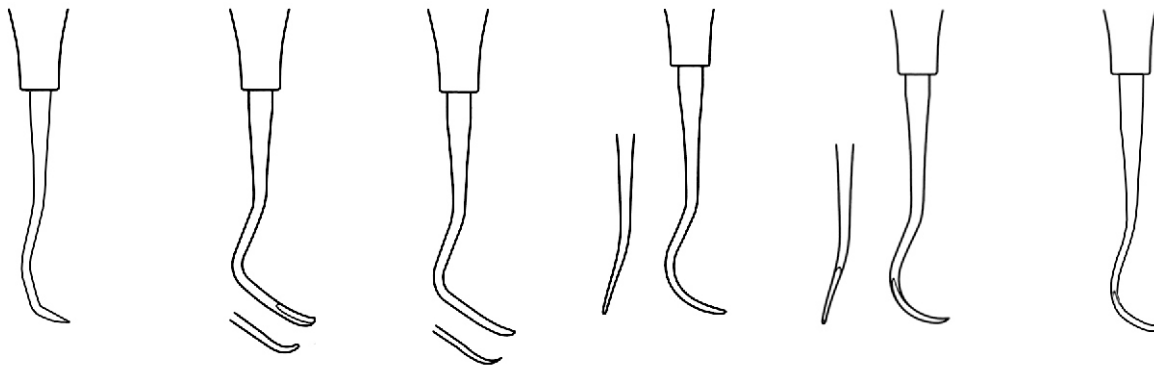

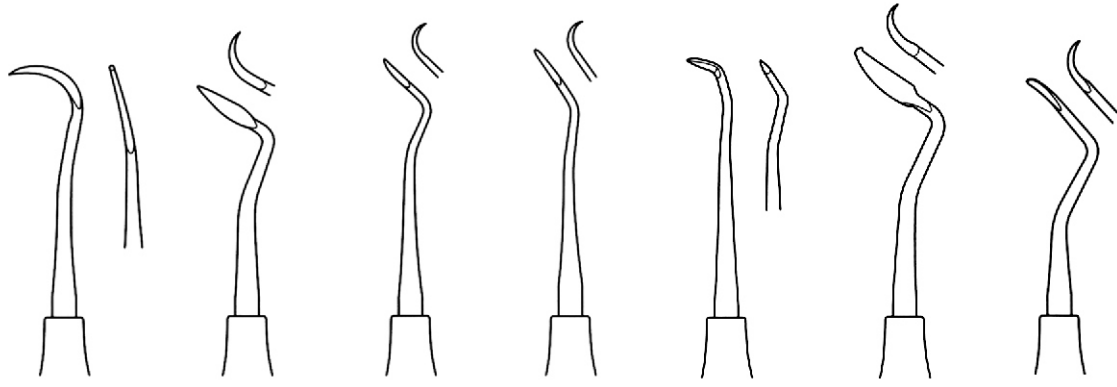

DS-1628
Hygienist
Fig. H6/H7

DS-1629
Fig. 204

DS-1630
Fig. 204 S

DS-1631
Fig. 204 SD

DS-1632
Zürich

DS-1633
Fig. CC 6

DS-1634
Fig. M 23

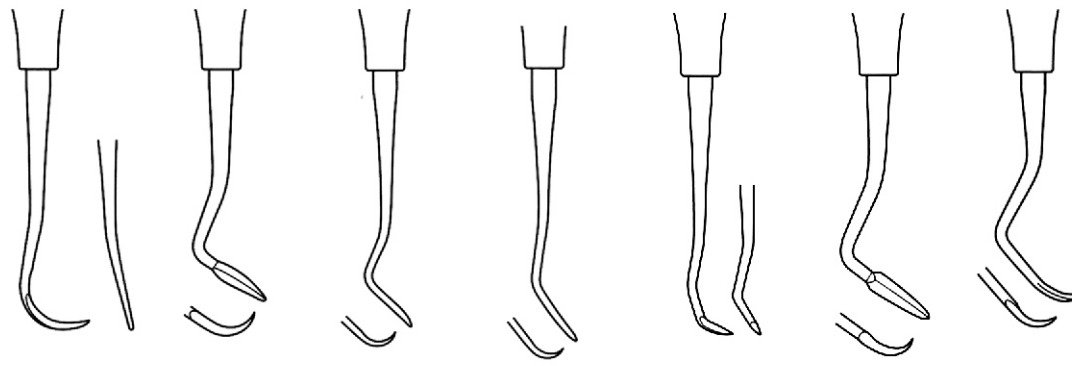

Sickle Scaler ●— EN
 SichelDS-Scaler ●— DE
 Escalador de hoz ●— ES



DS-1635 HygienistDS-Towner Fig. H5/33

DS-1636 Towner Fig. U15/30

DS-1637 Towner Fig. U15/33

DS-1638 HygienistDS-Towner Fig. H5/U15

DS-1639 Fig. U 135

DS-1640 Fig. CI 2/3

DS-1641 Taylor Fig. T2/T3

DS-1642 YoungerDS-Good Fig. 33/34



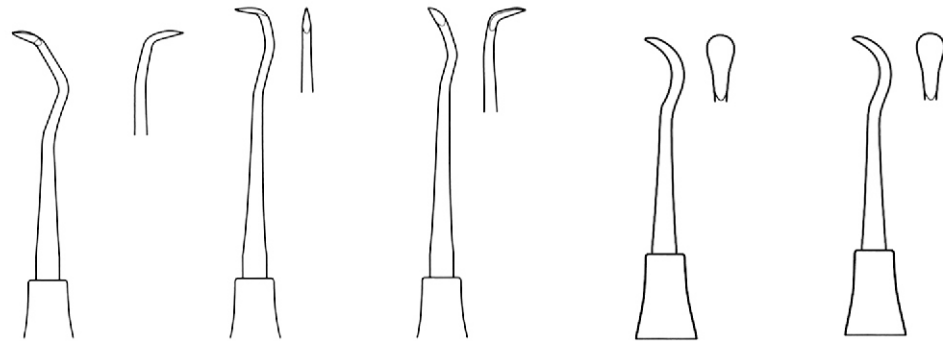

DS-1643
Jacquette
Fig. 31/32

DS-1644
Jacquette
Fig. 30/33

DS-1645
Jacquette
Fig. 34/35

DS-1646
Cumine
Fig. 33

DS-1647
Mitchell
Fig. 34

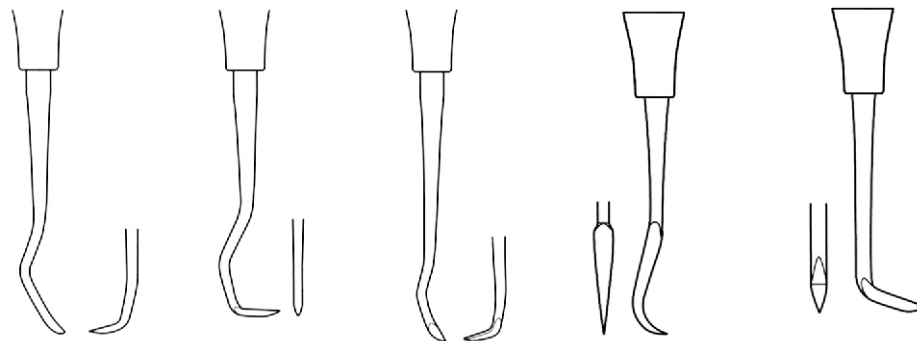

Sickle Scaler — EN
 SichelDS-Scaler — DE
 Escalador de hoz — ES

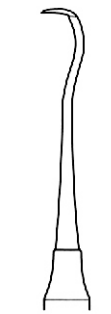

DS-1648
Jacquette
Fig. 33

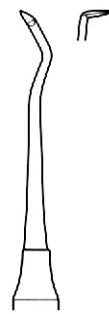

DS-1649
Jacquette
Fig. 34

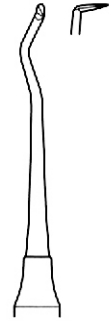

DS-1650
Jacquette
Fig. 35



DS-1651
WardDS-Kirkland
Fig. 1



DS-1652
CraneDS-Kaplan
Fig. 2



DS-1653
Mercitan
Fig. Sh5

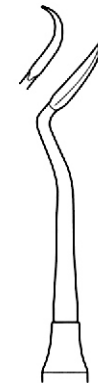

DS-1654
CraneDS-Kaplan
Fig. 3



DS-1655
White
Fig. 12B





Denis
Surgical

57

EN

Bone Currettes

DE

Knochenküretten

ES

Curetas de hueso

Page 79 to 84

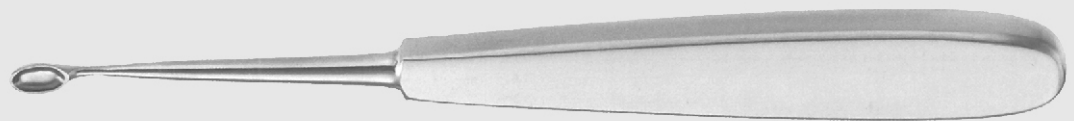



DS-1701
DS-1702

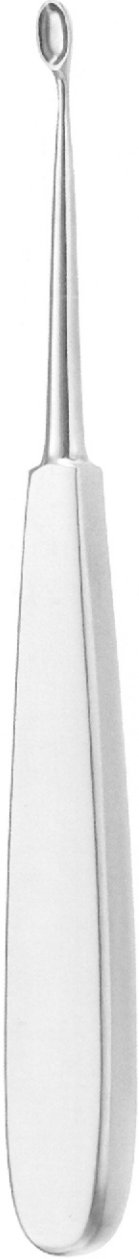

DS-1703
DS-1704

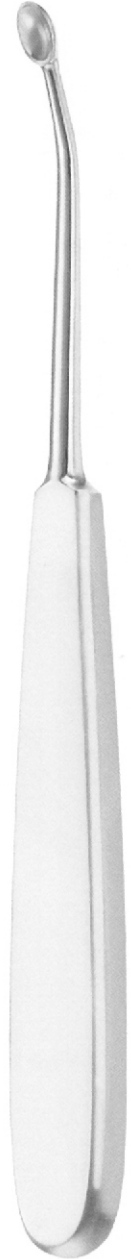

WILLIGER

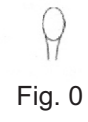
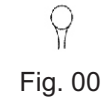

Fig. 00
Fig. 0
Fig. 1
Fig. 2

DS-1705
DS-1706
DS-1707
DS-1708

DS-1709
DS-1710
DS-1711
DS-1712

DS-1713
DS-1714
DS-1715
DS-1716

DS-1717
DS-1718
DS-1719
DS-1720

Bone Curettes ● EN
 Scharf Löffel ● DE
 Curettes á os ● ES



Mod. USA



Fig. 1	DS-1721		
Fig. 2	DS-1722		
Fig. 3	DS-1723		
Fig. 4	DS-1724		
Fig. 5	DS-1725		
Fig. 6	DS-1726		
		R	L
		DS-1727	DS-1733
		DS-1728	DS-1734
		DS-1729	DS-1735
		DS-1730	DS-1736
		DS-1731	DS-1737
		DS-1732	DS-1738

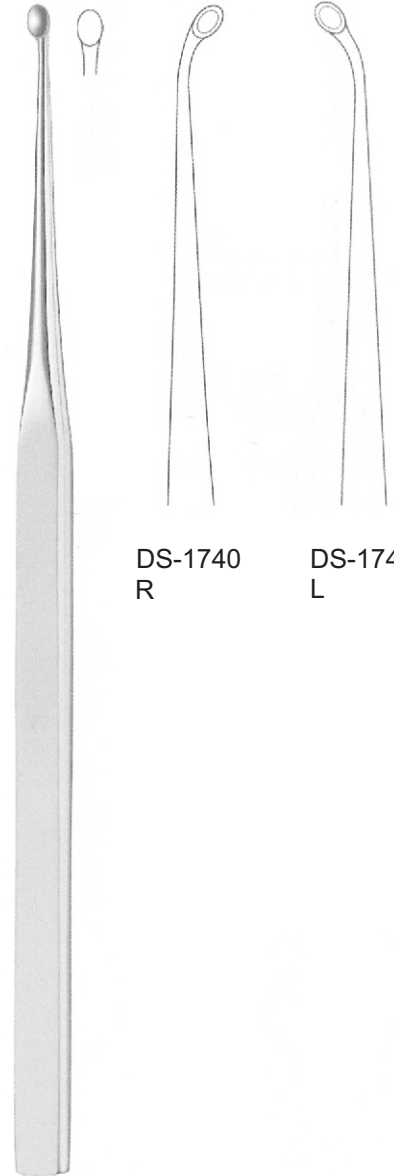
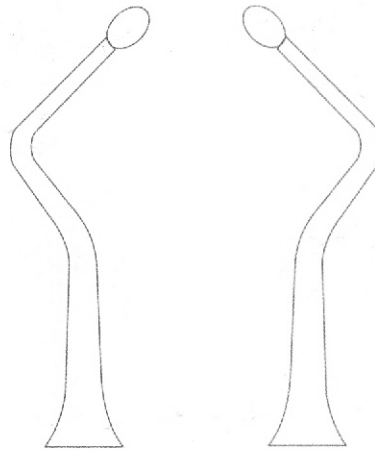

DS-1740
R

DS-1741
L

CHOMPRET
DS-1739





WILLGER

DS-1742
Fig. 00/00

DS-1743
Fig. 0/0

DS-1744
Fig. 1/1

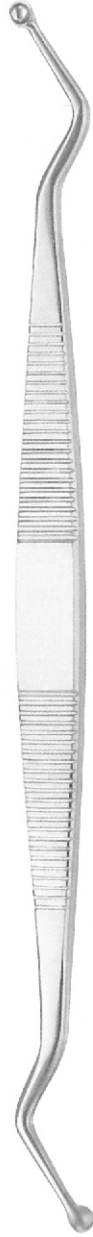

MARTINI

DS-1745
Fig. 00/00

DS-1746
Fig. 0/0

DS-1747
Fig. 1/1

DS-1748DS- DS-1750RDS-
DS-1749 DS-1751R

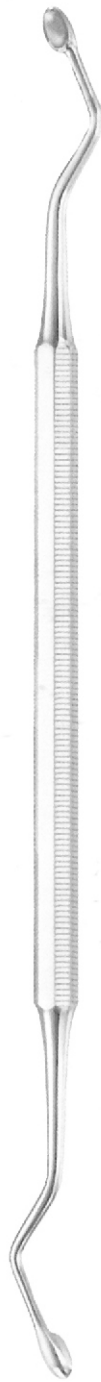

HEMINGWAY
18 CM/7"

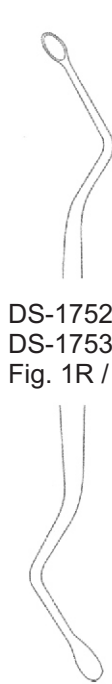

DS-1752
DS-1753
Fig. 1R / 1L

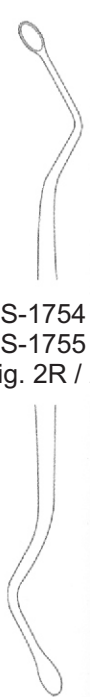

DS-1754
DS-1755
Fig. 2R / 2L

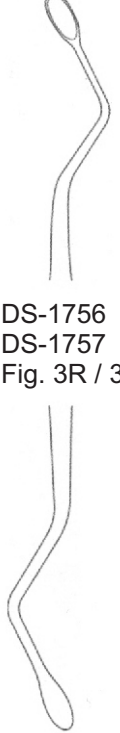

DS-1756
DS-1757
Fig. 3R / 3L

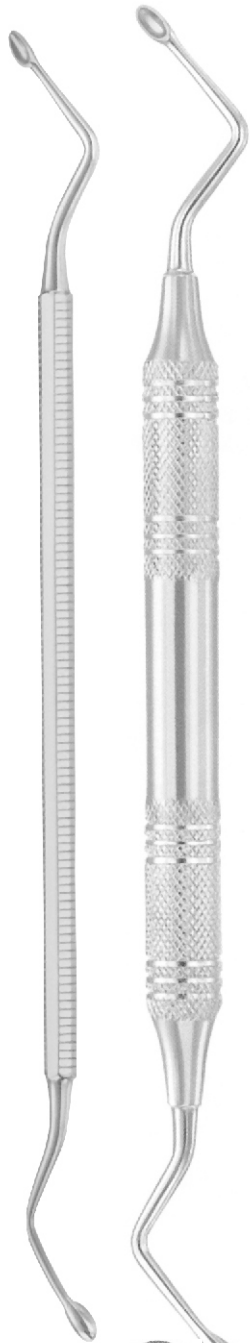

5,5 mm Ø9,5 mm
 HEMINGWAY
 17 cm/6 ¾"

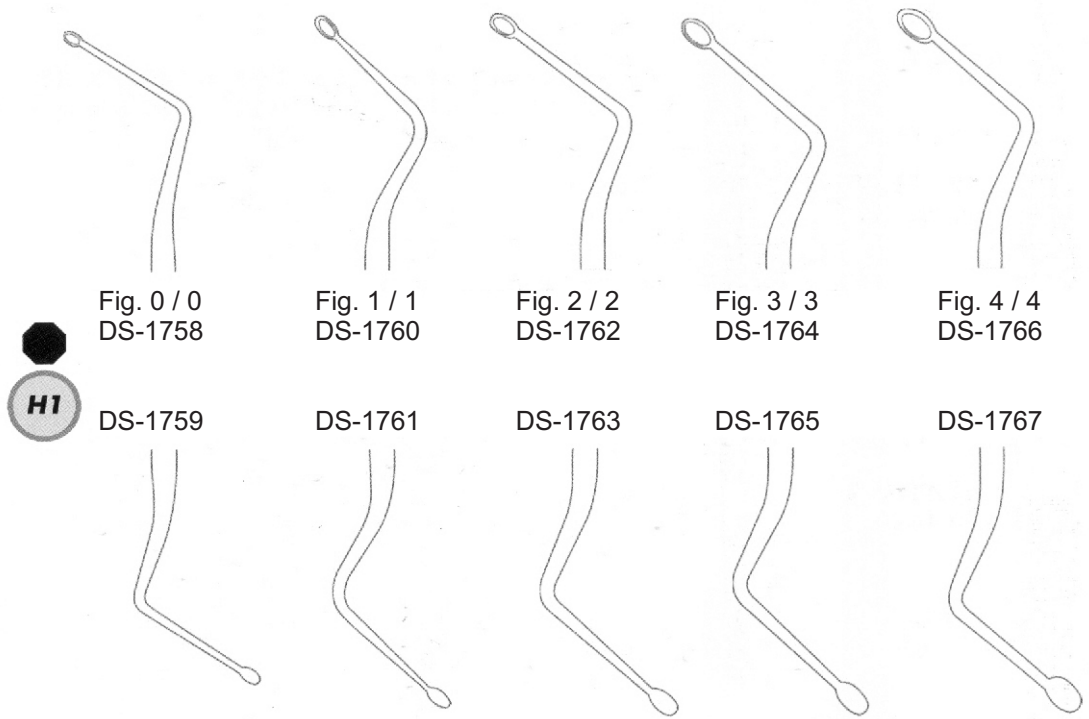

●	Fig. 0 / 0 DS-1758	Fig. 1 / 1 DS-1760	Fig. 2 / 2 DS-1762	Fig. 3 / 3 DS-1764	Fig. 4 / 4 DS-1766
H1	DS-1759	DS-1761	DS-1763	DS-1765	DS-1767

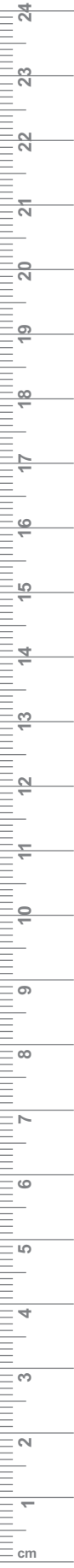

DS-1768
DS-1769

DS-1770
DS-1771

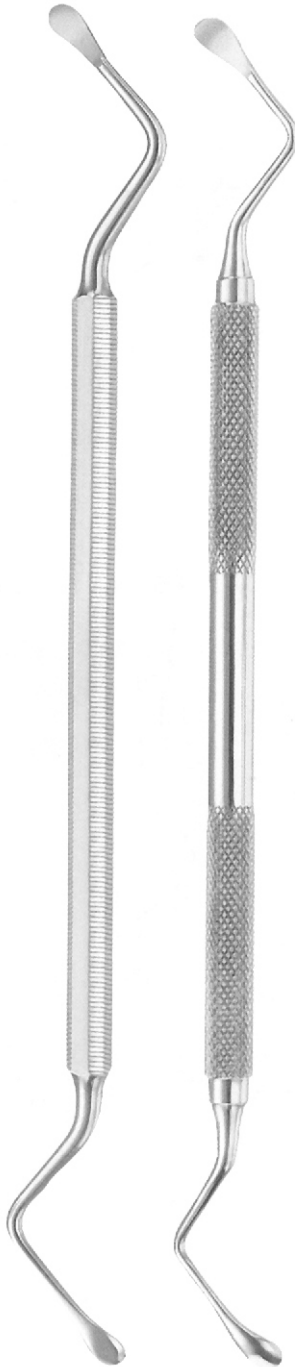

LUCAS
17 cm/6¾"



DS-1772
DS-1773
Fig. 1 / 1



DS-1774
DS-1775
Fig. 2 / 2



DS-1776
DS-1777
Fig. 3 / 3

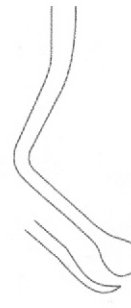

DS-1778
DS-1779
Fig. 4 / 4

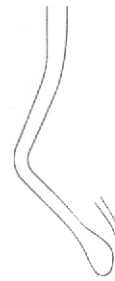

Bone Curettes ● EN
 Scharf Löffel ● DE
 Curettes á os ● ES

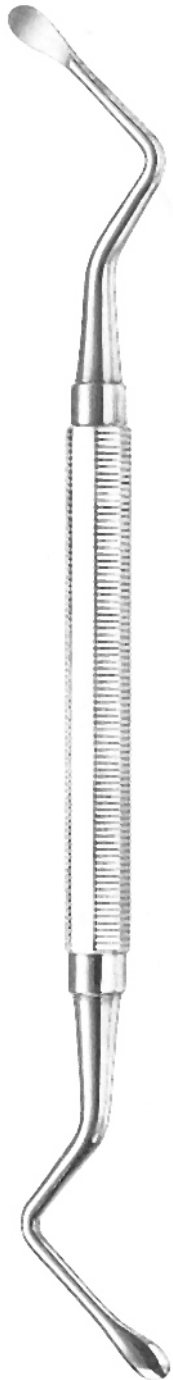

Fig. 4

DS-1780



Fig. 5

MEAD
DS-1781



Fig. 1

DS-1782



Fig. 2

DS-1783



Fig. 3

MILLERDS-COLBURN
DS-1784



Fig. 4

DS-1785





Denis
Surgical

58

- EN** Excavators
- DE** Bagger
- ES** Excavadoras

Page 85 to 89





DS-1800
Fig.72/73

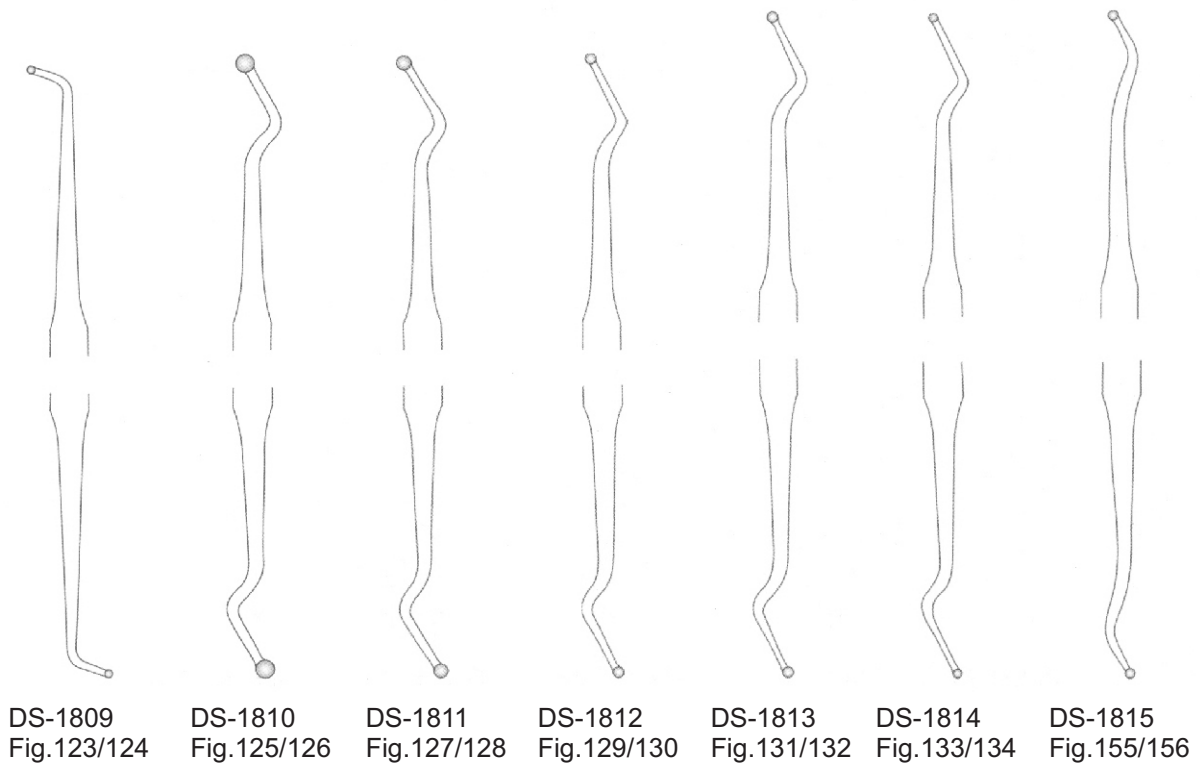
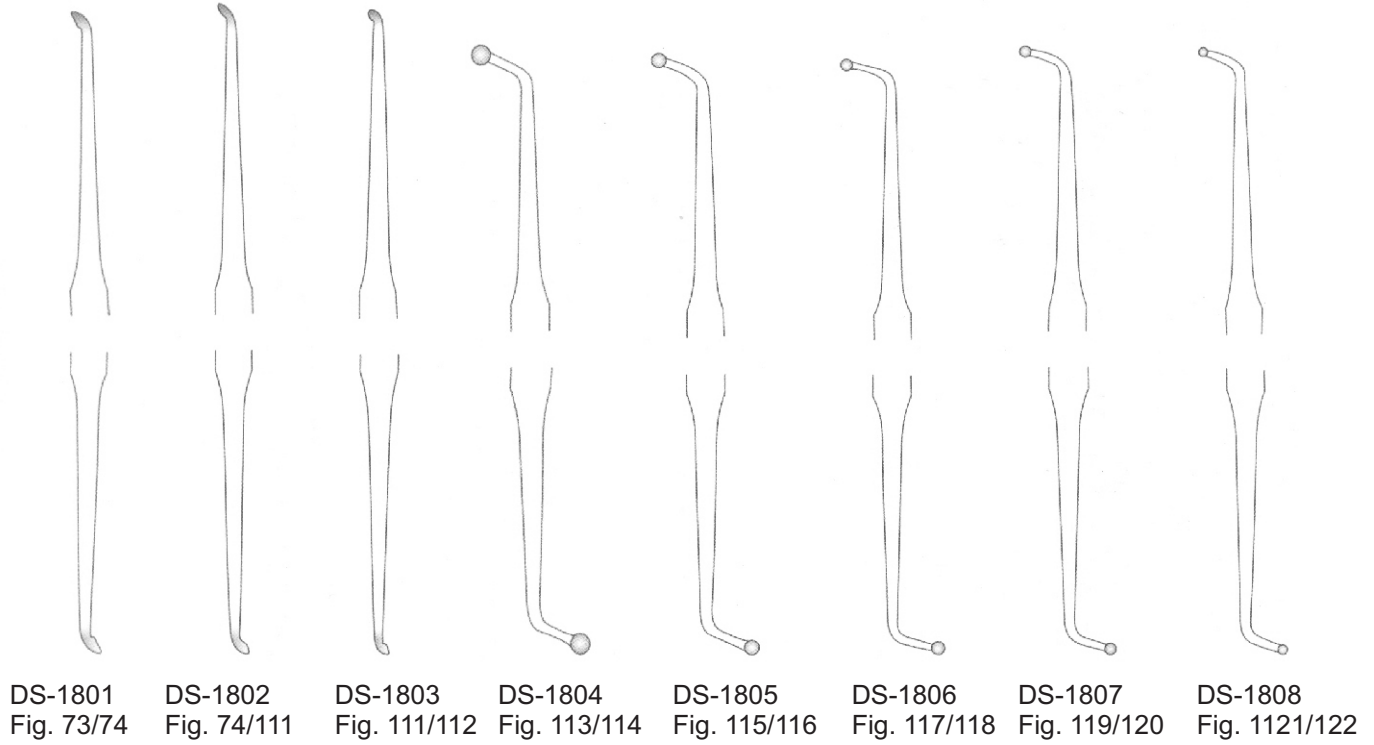

Excavators ●— EN
 Exkavatoren ●— DE
 Excavateurs ●— ES

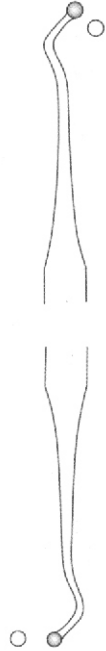

DS-1816
Fig.139/140

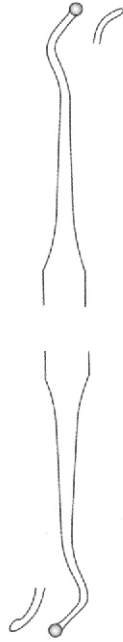

DS-1817
Fig.141/142



DS-1818
Fig.159/160

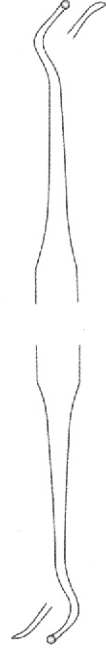

DS-1819
Fig.161/162



DS-1820
Fig.165/166



DS-1821
Fig.171/172



DS-1822
Fig.173/174



DS-1823
Fig.175/176



DS-1824
Fig.177/178



DS-1825
Fig.179/180

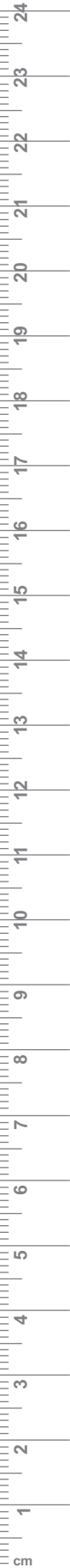



DS-1826
Fig. 5



DS-1827
Fig. 13



WHITE
DS-1828
Fig. 14



DS-1829
Fig. 15



DS-1830
Fig. 17



DS-1831
Fig. 18



DS-1832
Fig. 19



WHITE
DS-1833
Fig. 20



DS-1834
Fig. 23



DS-1835
Fig. 25

Excavators ● EN
 Exkavatorenen ● DE
 Excavateurs ● ES

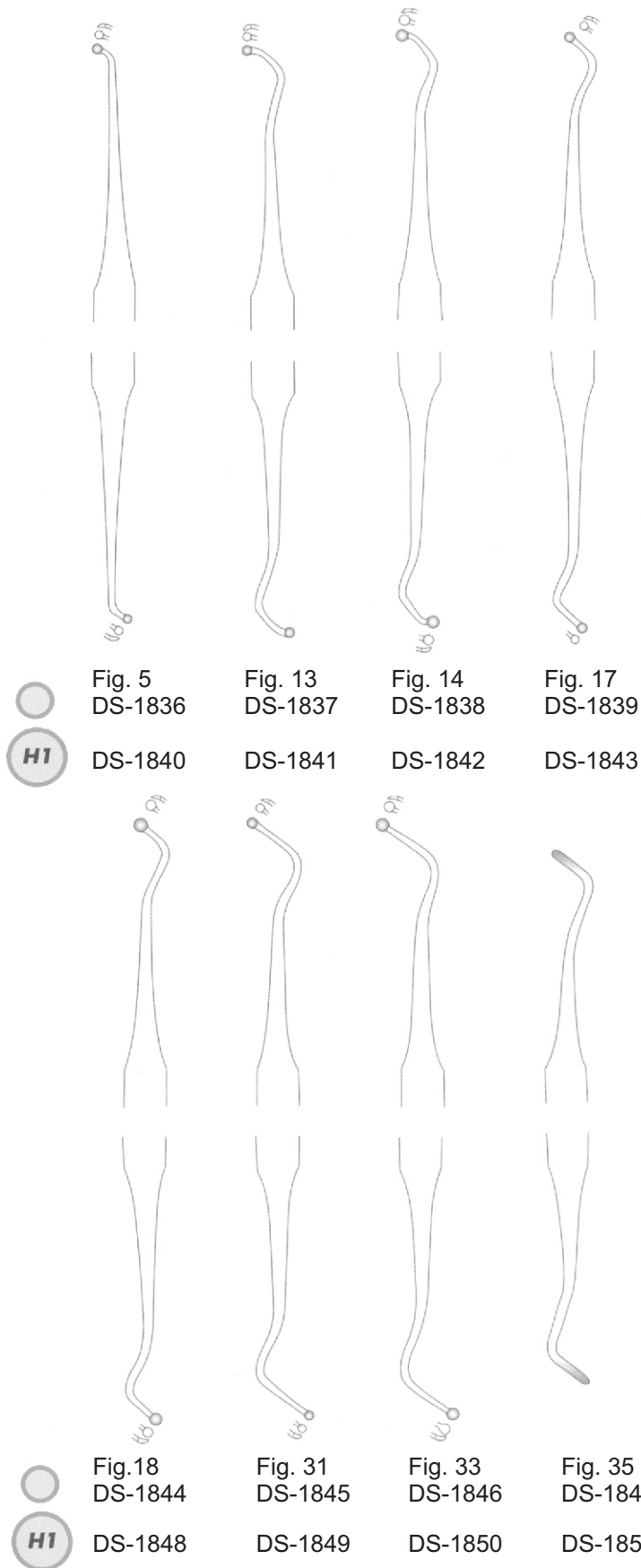

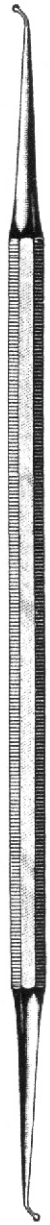

DS-1852
Fig. 5/6

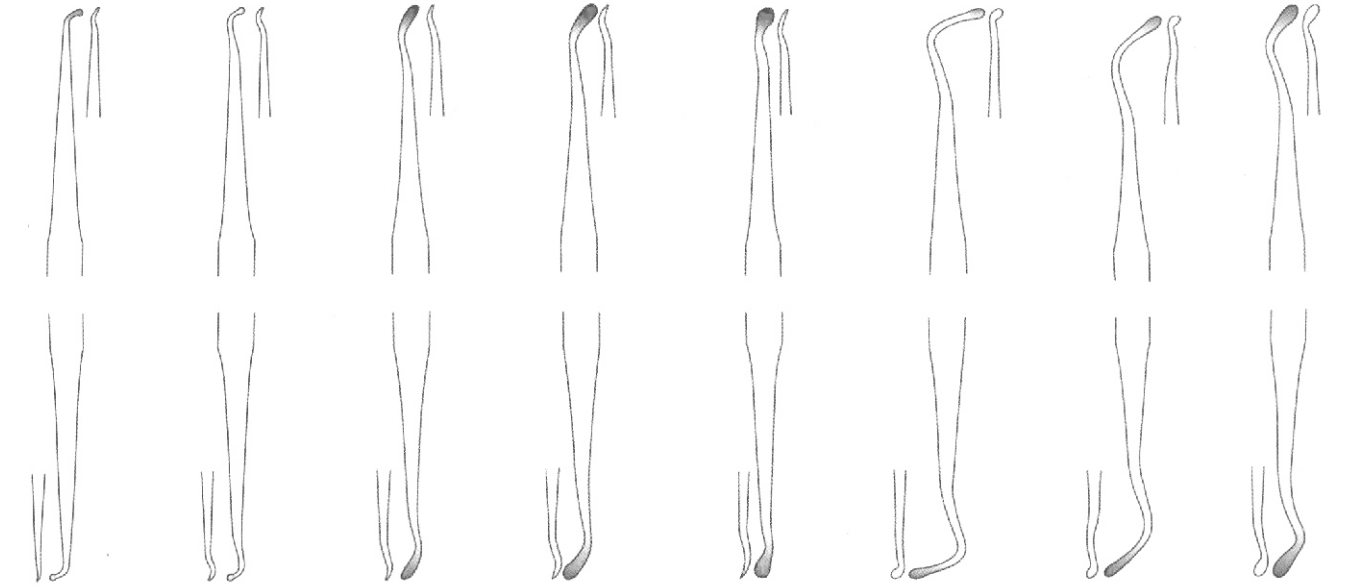

DS-1853
Fig. 7/8

DS-1854
Fig. 9/10

DS-1855
Fig. 11/12

DARBYDS-PERRY

DS-1856
Fig. 13/14

DS-1857
Fig. 15/16

DS-1858
Fig. 17/18

DS-1859
Fig. 19/20

DS-1860
Fig. 21/22

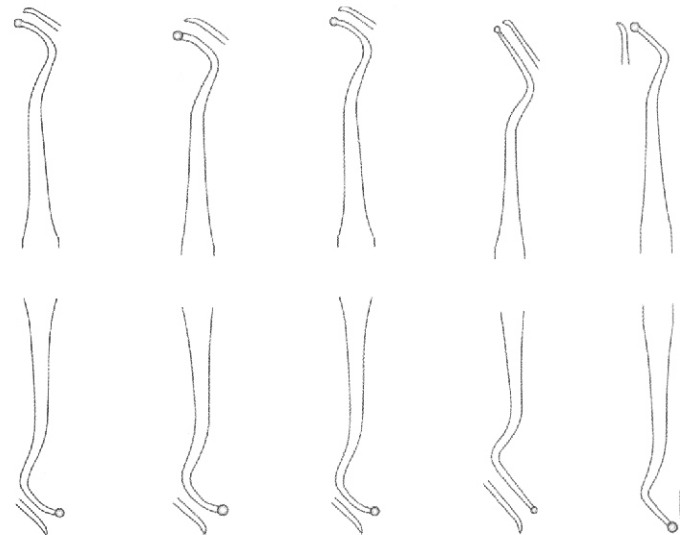

DS-1861
Fig. 4/5

DS-1862
Fig. 6/7

GILLET
DS-1863
Fig. 7/8

DS-1864
Fig. 12/13

DS-1865
Fig. 14/15



Denis
Surgical

59

- EN** Wax Proclein
- DE** WachsDS-Porzellan
- ES** cera Porcelana

Page 90 to 94





5,5 mm
 H1 Ø9,5 mm



●	DS-1901 Fig. 1	DS-1902 Fig. 2	DS-1903 Fig. 3	DS-1904 Fig. 4	DS-1905 Fig. 5
H1	DS-1906H	DS-1907H	DS-1908H	DS-1909H	DS-1910H
Aluminium	DS-1911	DS-1912	DS-1913	DS-1914	DS-1915
	gold	green	blue	red	silver

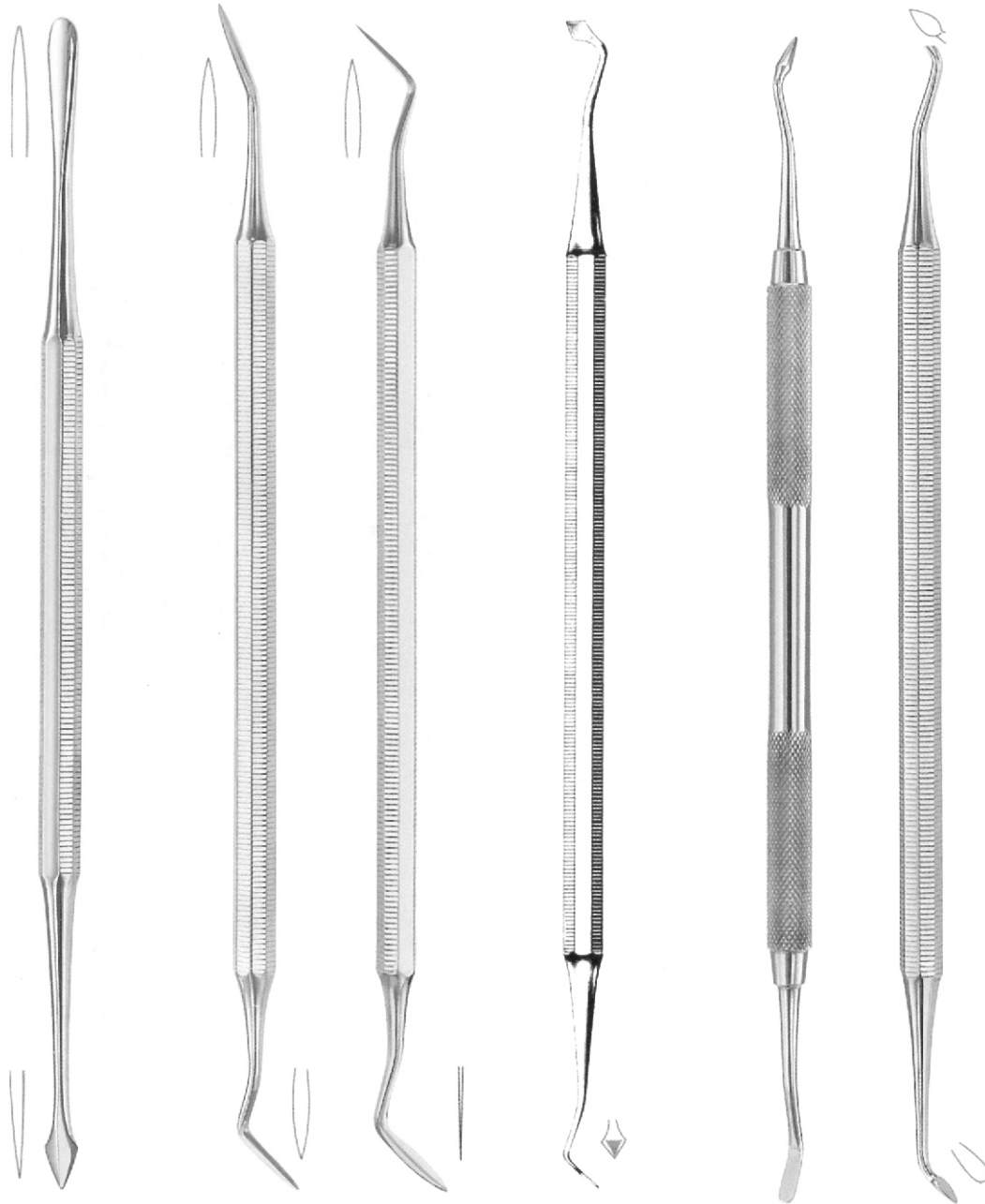

GRITMAN
DS-1916

WARD
DS-1917 Fig. 1
DS-1918 Fig. 2

FRAHM
DS-1919

SHOSHAN
DS-1920
SHODS-A

W.A.C.D
DS-1921

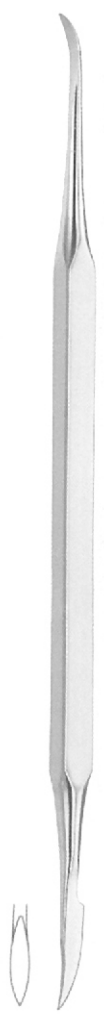

HYLIN
DS-1922



ZAHLE
DS-1923



ZAHLE
DS-1924



LE CRON
DS-1925



LE CRON
DS-1926

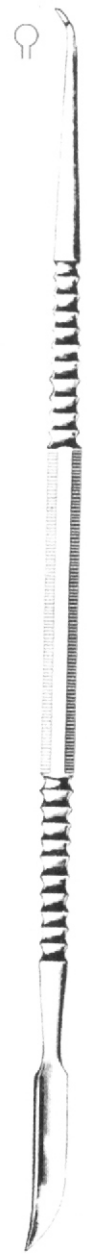

DS-1927

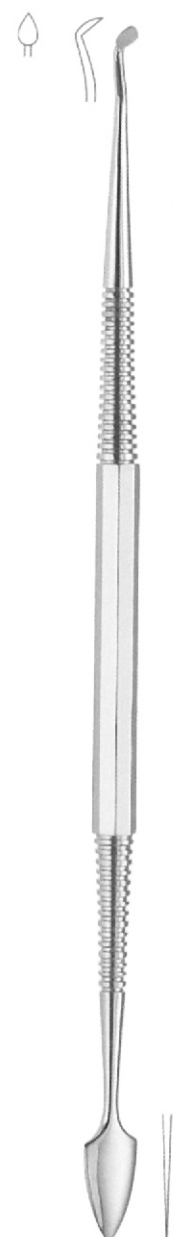

VEHE
DS-1928

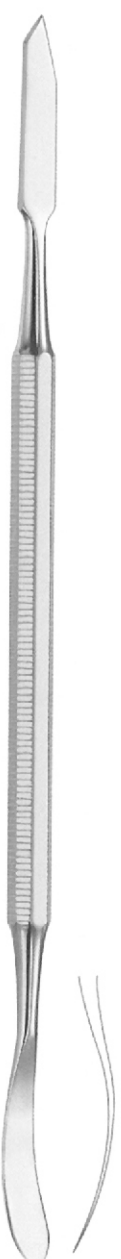

FIELDSTAD
DS-1929



ROACH
 DS-1930 DS-1931

RIEGNER
 DS-1932

DS-1933
 Fig. 1

DS-1934
 Fig. 2

FRAHM
 DS-1935
 Fig. 6

DS-1936
 Fig. 10

DS-1937
 Fig. 6/10

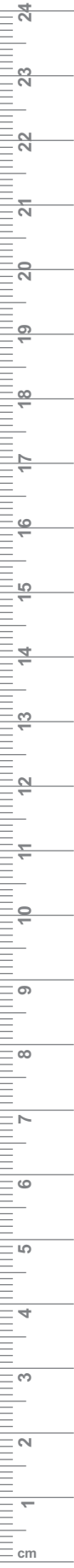

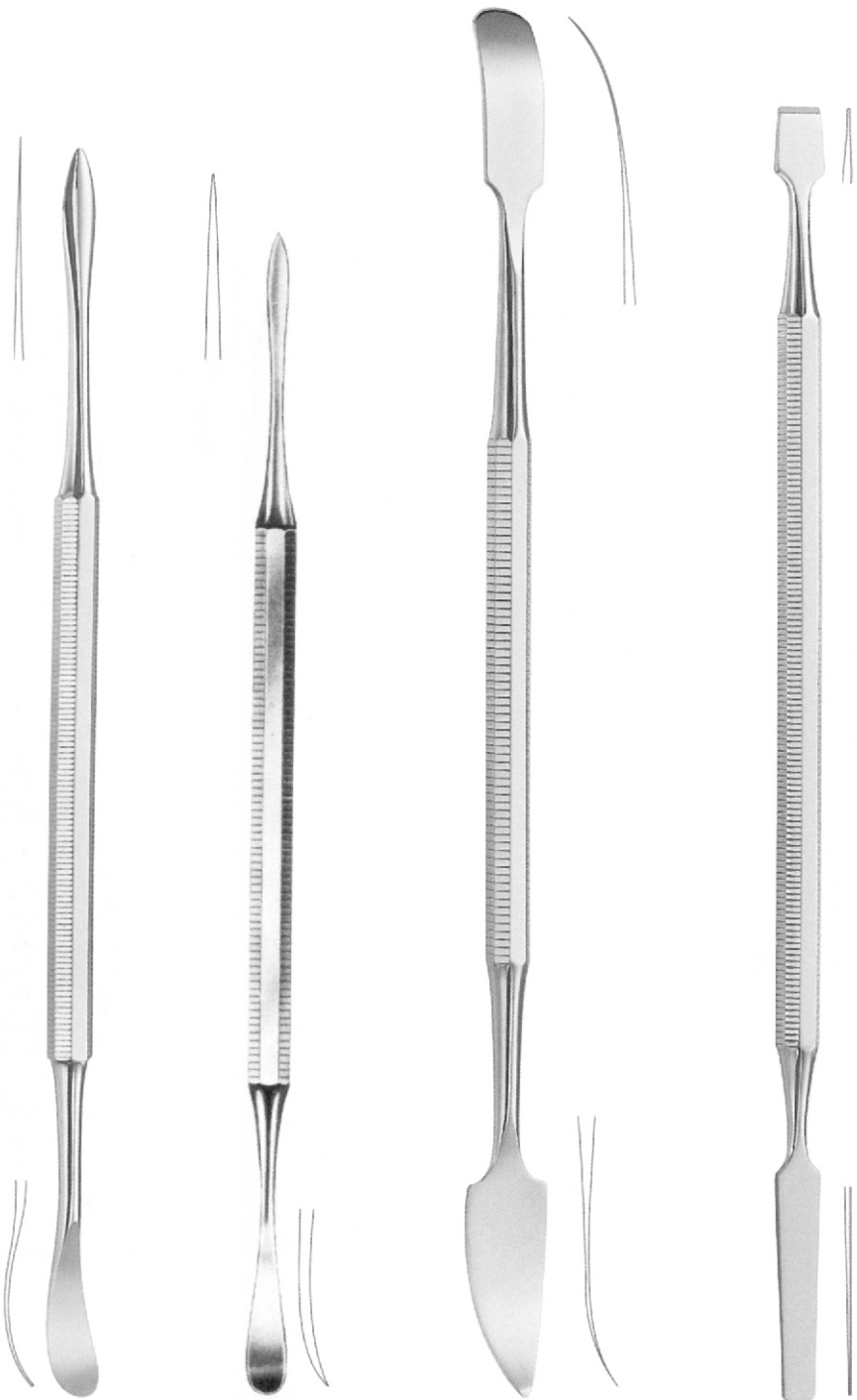

DS-1938
Fig. 7A

BEALE
DS-1939

GRITMAN
DS-1940
19,5 cm/7 3/4"

WESTON
DS-1941



Denis
Surgical

60

EN

Filling Instruments

DE

Füllungsinstrumente

ES

Actos de llenado

Page 95 to 105



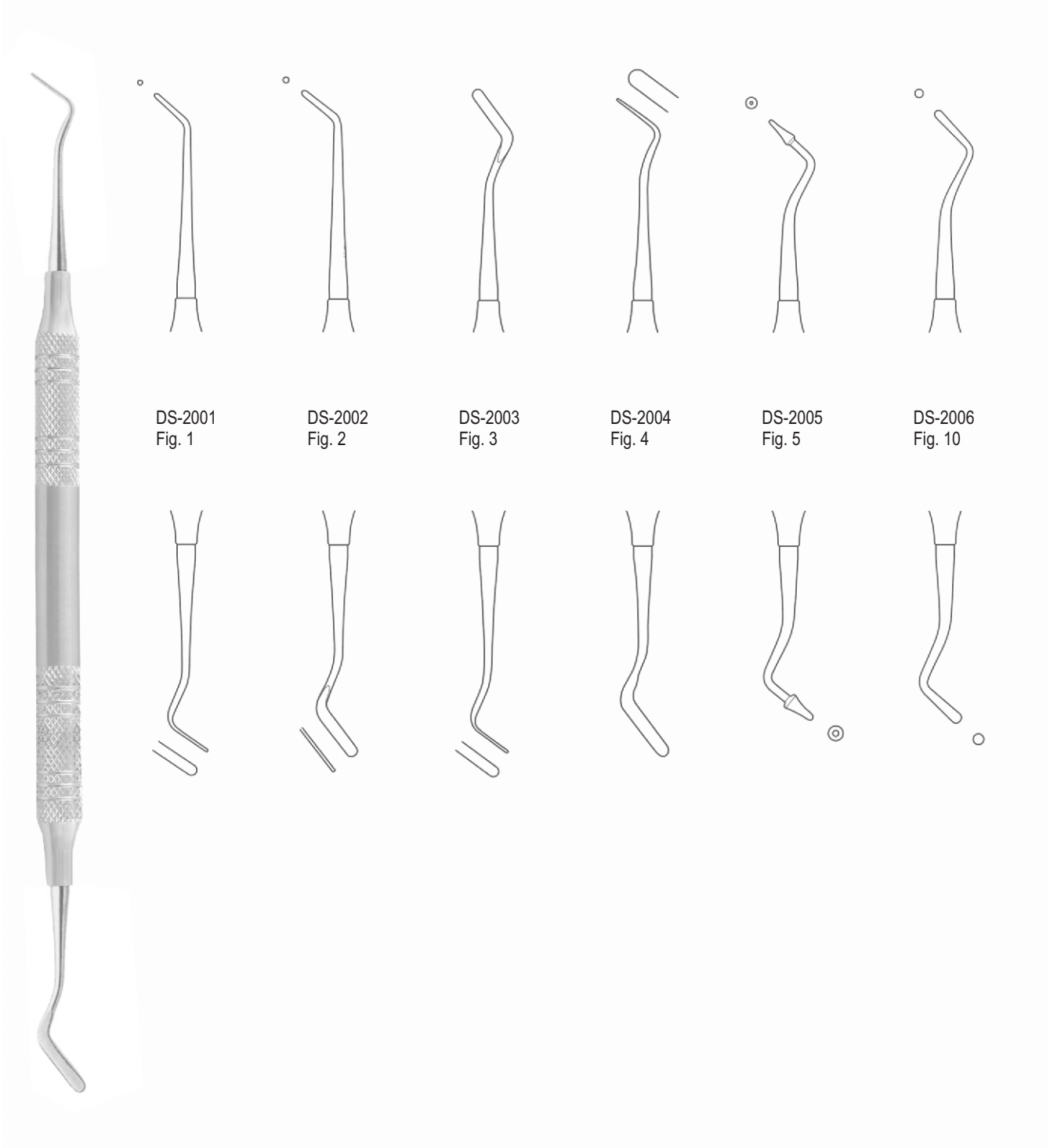

DS-2001
Fig. 1

DS-2002
Fig. 2

DS-2003
Fig. 3

DS-2004
Fig. 4

DS-2005
Fig. 5

DS-2006
Fig. 10

Note: Titanium Coated Points are available on customer demand.

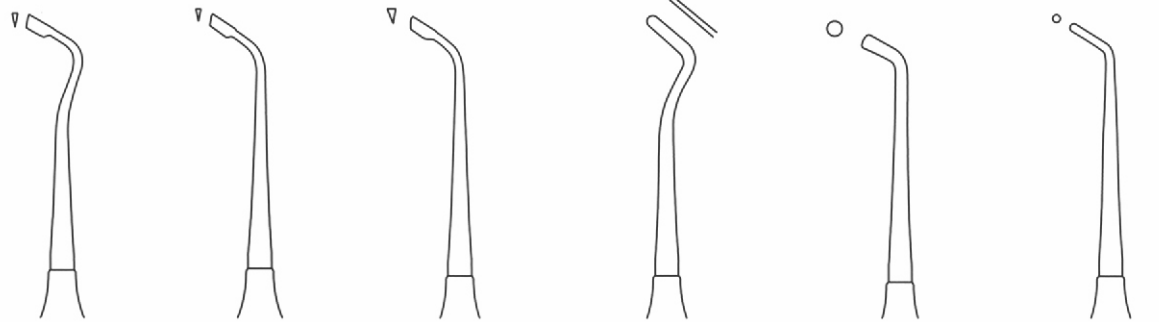

DS-2007
Fig. 1
Felt

DS-2008
Fig. 2
Felt

DS-2009
Fig. 3
Felt

DS-2010
Fig. 4
Felt

DS-2011
Fig. 5
Felt

DS-2012
Fig. 6
Felt

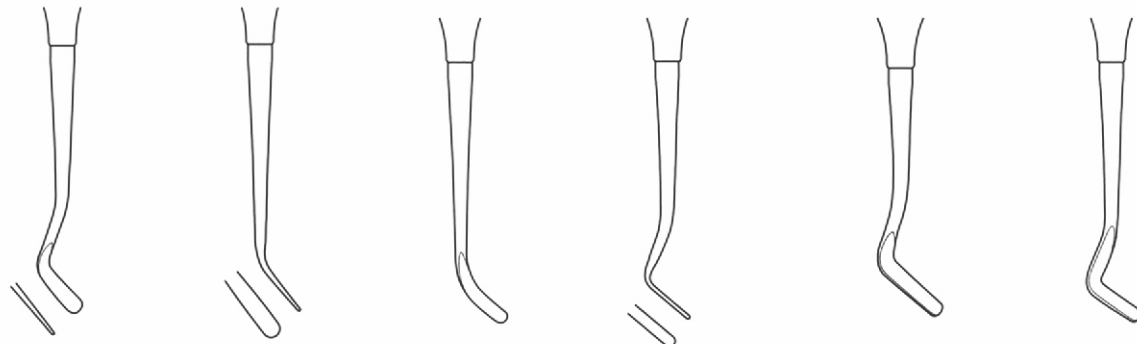

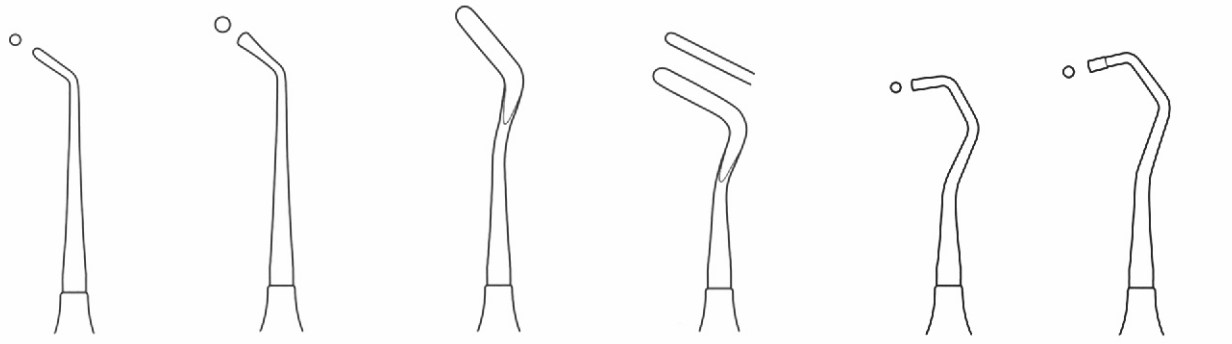

DS-2013
Fig. 1
Goldstein

DS-2014
Fig. 2
Goldstein

DS-2015
Fig. 3
Goldstein

DS-2016
Fig. 4
Goldstein

DS-2017
Fig. 9/10

DS-2018
Fig. 11/12

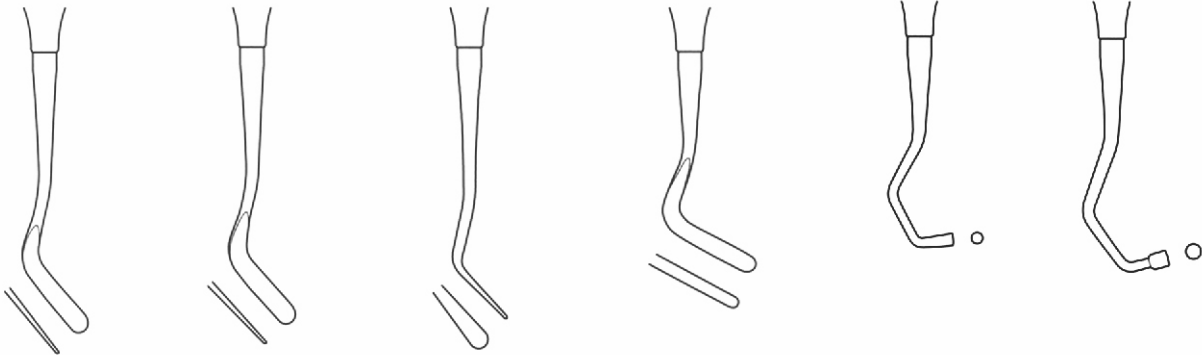

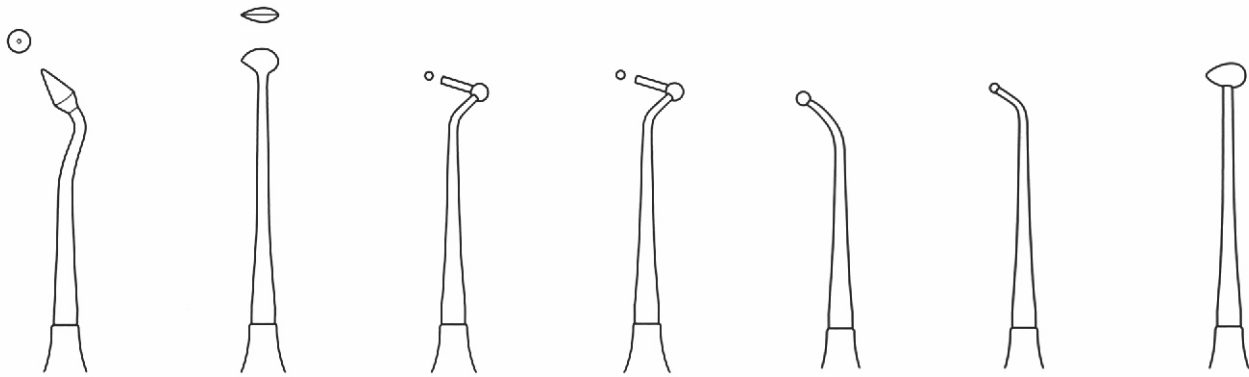

DS-2019
Fig. SB

DS-2020
Fig. 29/2B

DS-2021
Fig. L1
Loesche

DS-2022
Fig. L2
Loesche

DS-2023
Fig. 18
Ball Burnisher

DS-2024
Fig. 26/27S
Ball Burnisher

DS-2025
Fig. 28/29
Ball Burnisher

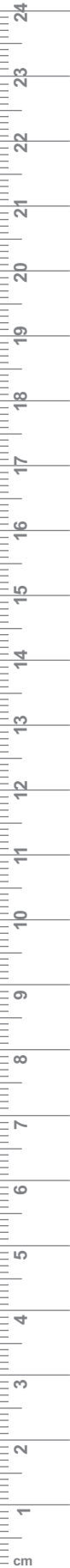
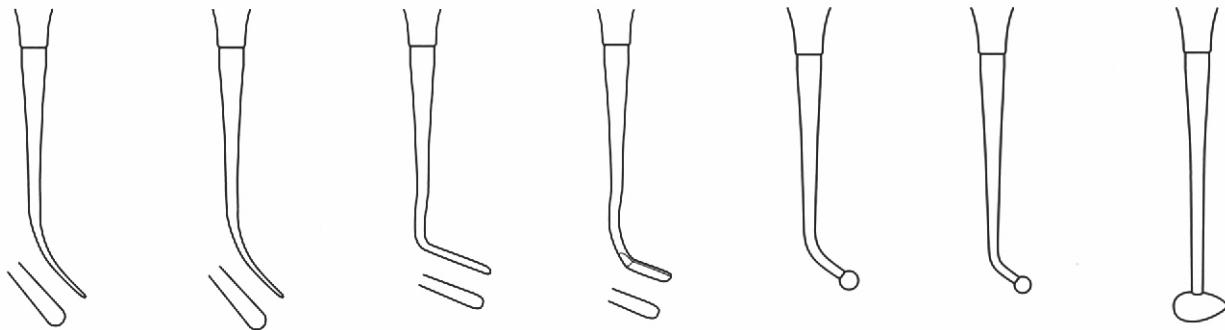



DS-2026
Fig. 1S



DS-2027
Fig. 2S



DS-2028
Fig. 3S



DS-2029
Fig. 4S



DS-2030
Fig. 1P



DS-2031
Fig. 2P



DS-2032
Fig. 3P





DS-2033
Fig. 4P



DS-2034
Fig. 1D



DS-2035
Fig. 2D



DS-2036
Fig. 3D



DS-2037
Fig. M1
Markley



DS-2038
Fig. M2



DS-2039
Fig. M3



DS-2040
Fig. M4

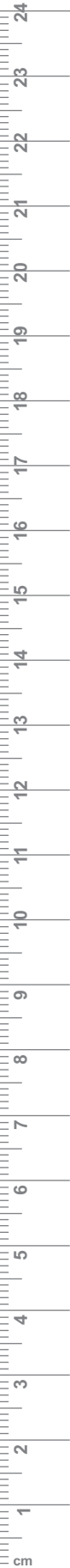

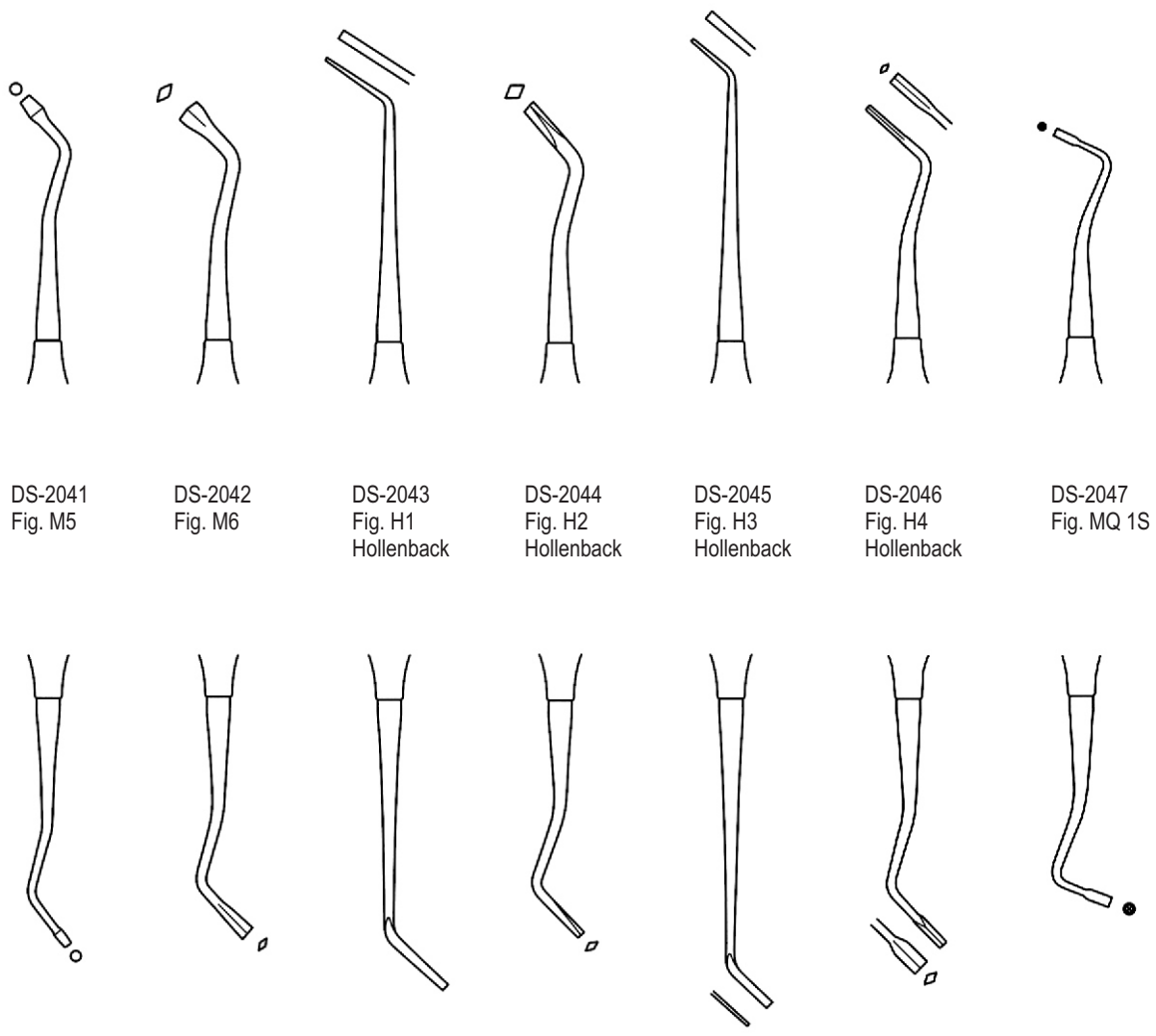

DS-2041
Fig. M5

DS-2042
Fig. M6

DS-2043
Fig. H1
Hollenback

DS-2044
Fig. H2
Hollenback

DS-2045
Fig. H3
Hollenback

DS-2046
Fig. H4
Hollenback

DS-2047
Fig. MQ 1S

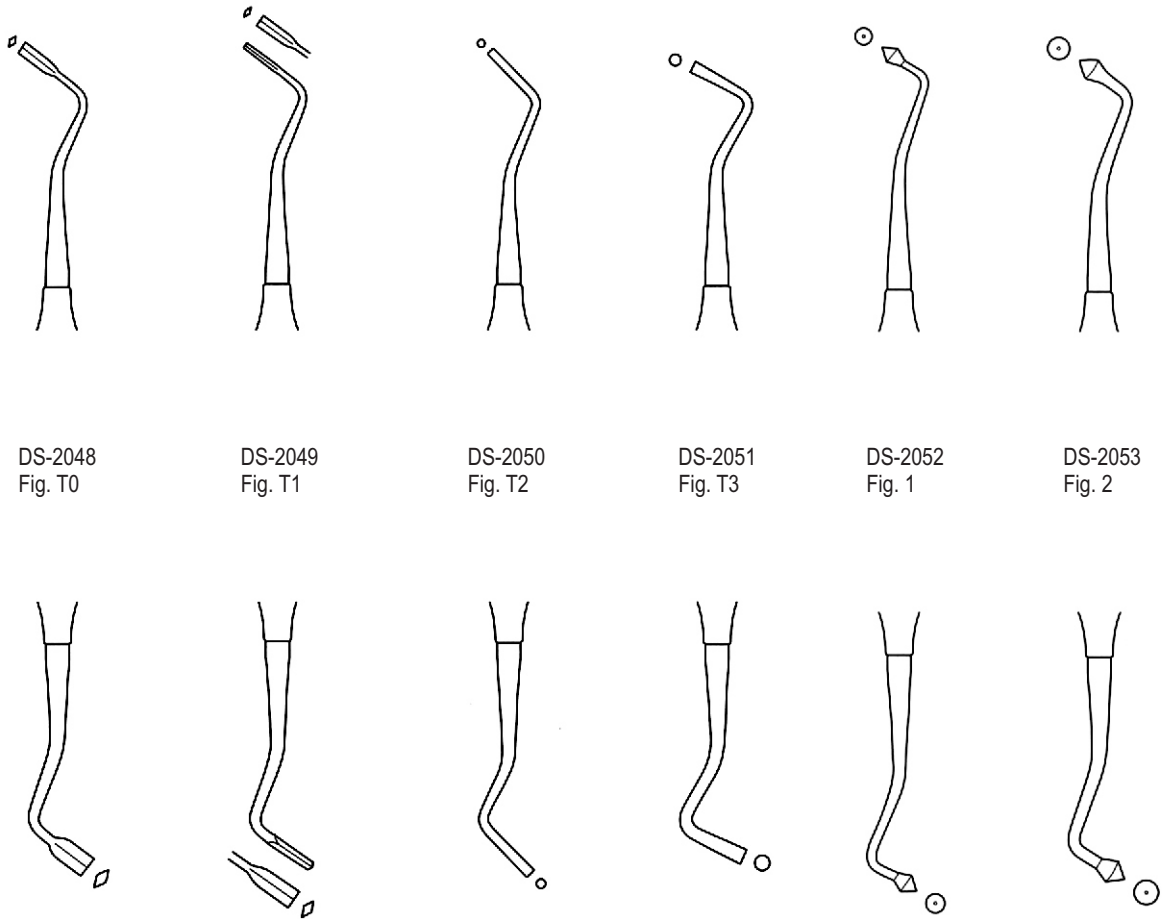

DS-2048
Fig. T0

DS-2049
Fig. T1

DS-2050
Fig. T2

DS-2051
Fig. T3

DS-2052
Fig. 1

DS-2053
Fig. 2





DS-2054
Fig. 3

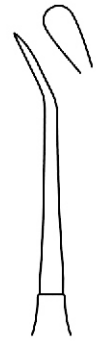

DS-2055
Fig. WO 1
Woodson



DS-2056
Fig. WO 2
Woodson



DS-2057
Fig. WO 3
Woodson



DS-2058
Fig. L2
Ladmore



DS-2059
Fig. L3
Ladmore

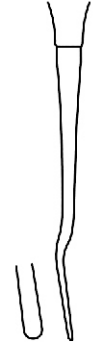

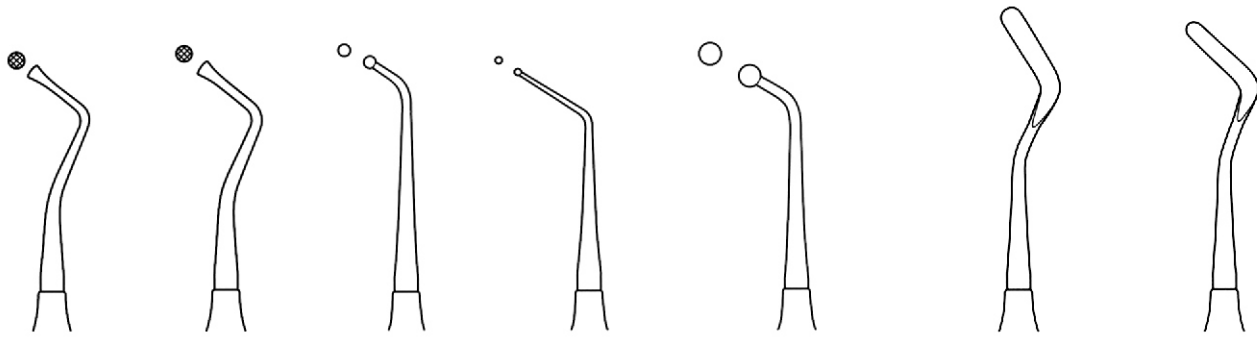

DS-2060
Fig. 1
Ward

DS-2061
Fig. 2
Ward

DS-2062
Fig. 7A

DS-2063
Fig. 19

DS-2064
Fig. 7B

DS-2065
Fig. 6

DS-2066
Fig. 11

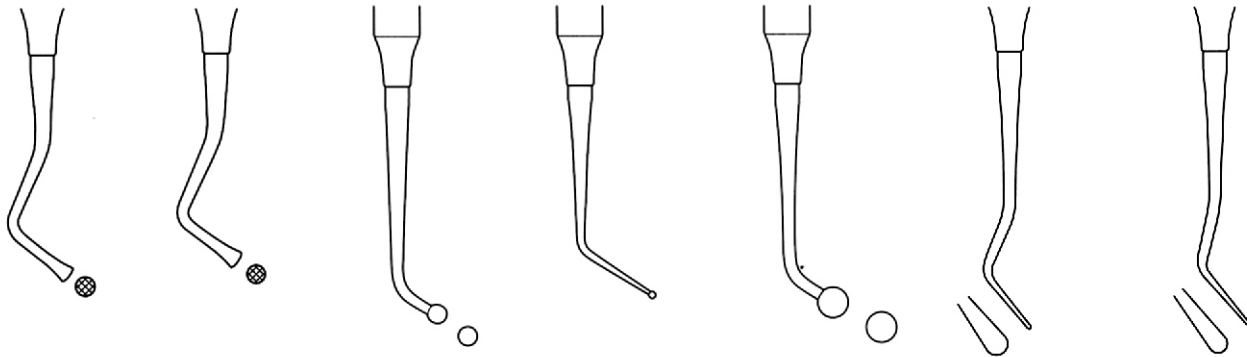



DS-2067
Fig. 179



DS-2068
Fig. 1
2 mm



DS-2069
Fig. 2
2.5 mm



DS-2070
Fig. 3
3 mm



DS-2071
Fig. 11



DS-2072
Fig. 12



DS-2073
Fig. 13

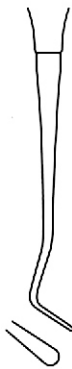



Denis
Surgical

61

- EN** Gingivectomy Knives
- DE** Gingivektomie Messer
- ES** Cuchillos de gingivectomía

Page 106 to 107





DS-2101
GoldmanDS-Fox
Fig. 7



DS-2102
GoldmanDS-Fox
Fig. 8



DS-2103
GoldmanDS-Fox
Fig. 9



DS-2104
GoldmanDS-Fox
Fig. 10



DS-2105
GoldmanDS-Fox
Fig. 11



DS-2106
Kirkland
Fig. 15K/16K



Periodontal Knives ● EN
 Parodontale Messer ● DE
 Cuchillos periodontales ● ES

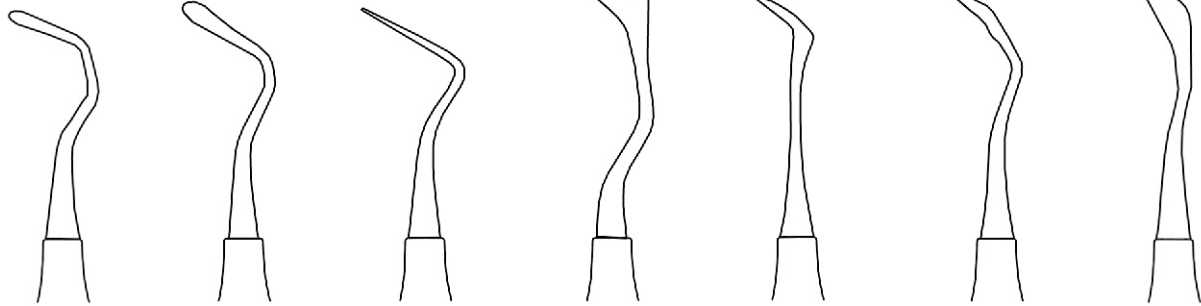

DS-2107 Fig. 1 Reddy Thin
 DS-2108 Fig. 2 Reddy Thin
 DS-2109 Fig. 1/2 Sanders
 DS-2110 Fig. 19/20 USC Towner
 DS-2111 Fig. CKDS-3 Crane Kaplan
 DS-2112 Fig. CKDS-6 Crane Kaplan
 DS-2113 Fig. 1/2 Solt

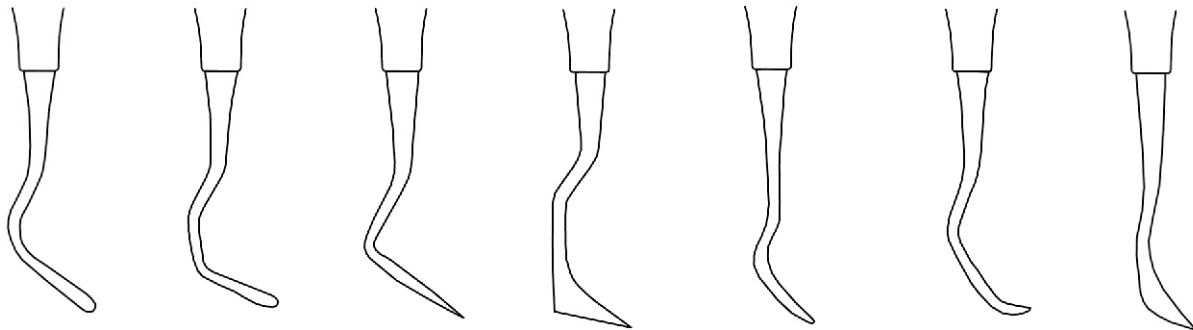



Denis
Surgical

62

- EN** Cement Spatulas
- DE** Zementspatel
- ES** Espátulas de cemento

Page 108 to 112

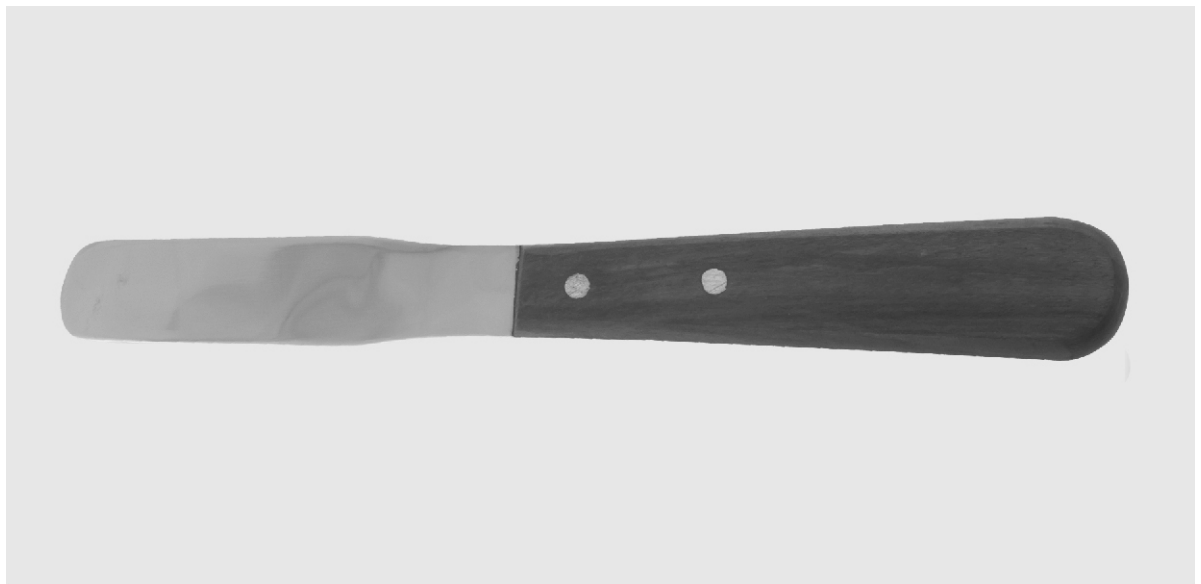

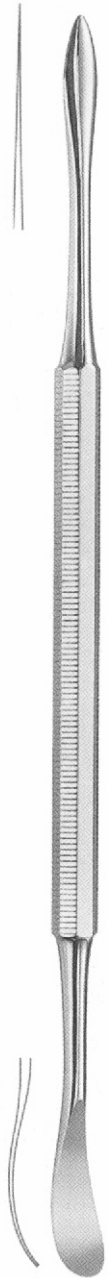

DS-2151
 Fig. 26
 Distal

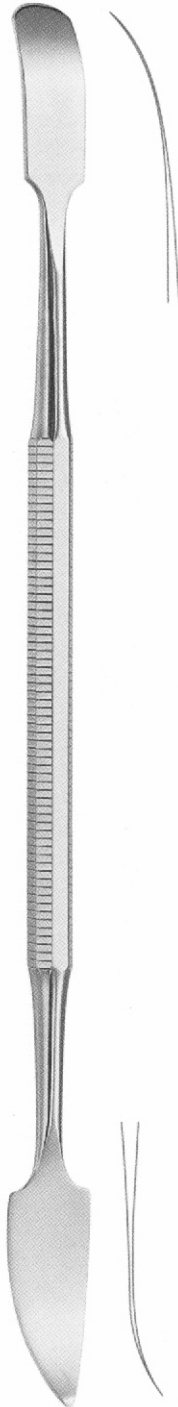

DS-2152
 Fig. 27
 Mesial

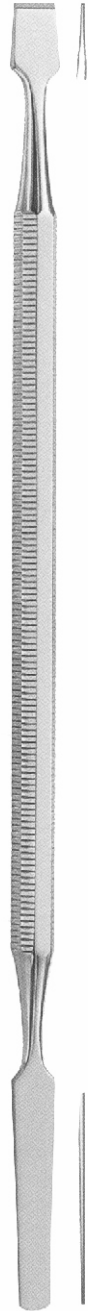

DS-2153
 Fig. 29
 Mesial



DS-2154
 Fig. 29
 Mesial

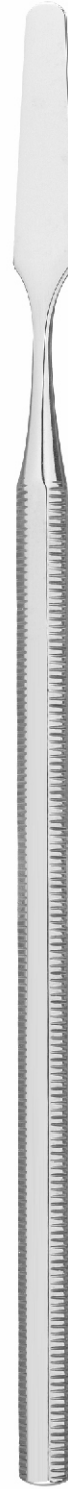

DS-2155
 Fig. 77/78
 Distal



DS-2156
 Mesial
 54DS-1142DS-00



DS-2157
 Fig. 28
 Distal

Wooden Handle

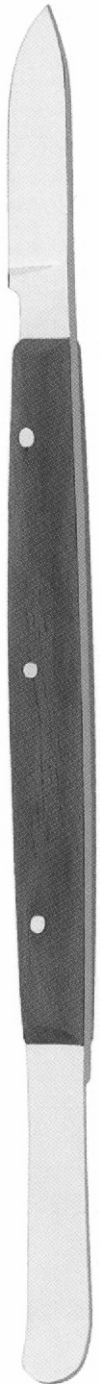

DS-2158
Fig. 28
Distal



DS-2159
Fig. 28
Distal



DS-2160
Fig. 28
Distal



DS-2161
Fig. 28
Distal

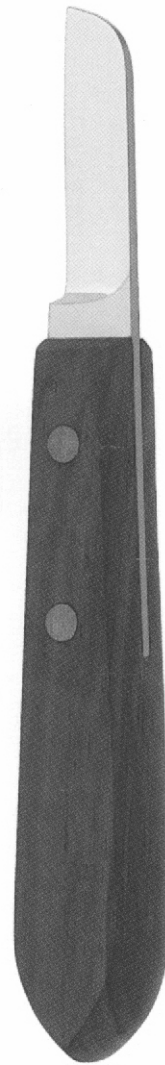

DS-2162
Fig. 28
Distal

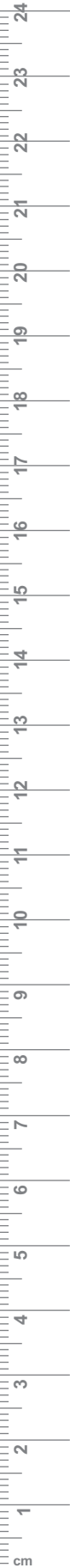



CEMENT SPATULAS



DS-2163
Fig. 1



Fig. 2



Fig. 3



Fig. 4



Fig. 5

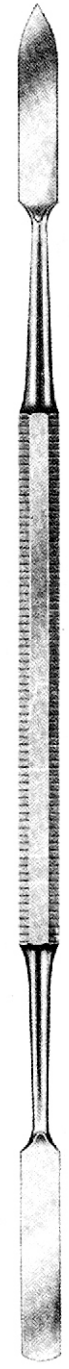

Fig. 1



Fig. 2
DS-2164



Fig. 3

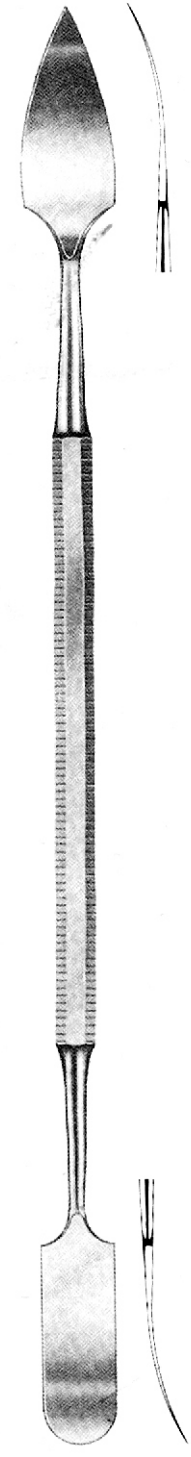

DS-2165
Fig. 31
Gritman

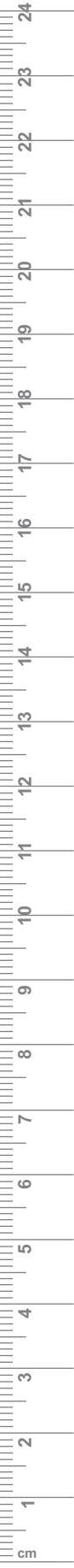
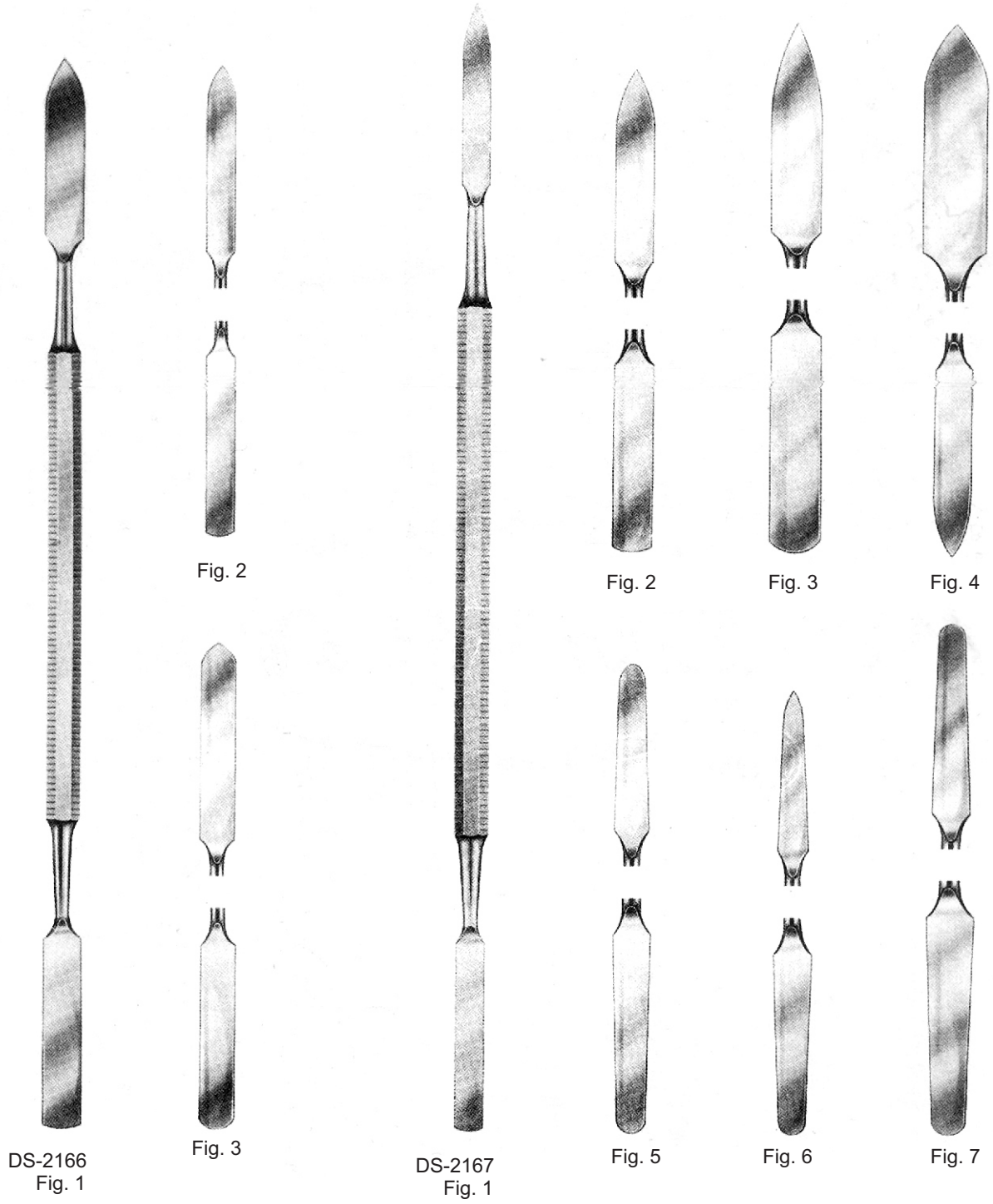

DS-2166
Fig. 1

Fig. 3

DS-2167
Fig. 1

Fig. 5

Fig. 6

Fig. 7



DS-2168
Fig. 1



Fig. 2



Fig. 4



Fig. 5

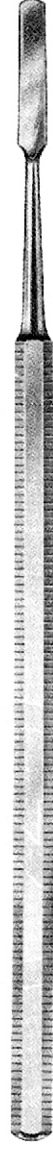

DS-2169
Fig. 313



Fig. 322



Fig. 324

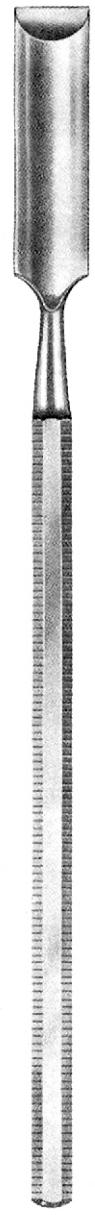

DS-2170



Fig. 6



Fig. 7



Fig. 8



Fig. 5



Fig. 8



Fig. 24 A



Fig. 25 E



Fig. 11



Fig. 12



Denis
Surgical

63

- EN** Mouth Mirrors
- DE** Mundspiegel
- ES** Espejos bucales

Page 113 to 115





Simple Stem



Plain
Magnifying
Front Surface

1 = 16 mm
 3 = 20 mm
 4 = 22 mm
 5 = 24 mm

DS-2301DS-16
 DS-2301DS-20
 DS-2301DS-22
 DS-2301DS-24



Plain
Magnifying
Front Surface

4 = 22 mm
 5 = 24 mm

DS-2302DS-22
 DS-2302DS-24



Plain
Magnifying
Front Surface

3 = 20 mm
 4 = 22 mm
 5 = 24 mm

DS-2303DS-20
 DS-2303DS-22
 DS-2303DS-24

Cone Socket

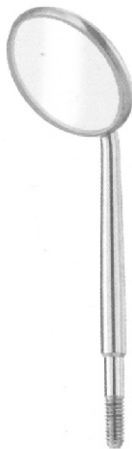

Plain
Magnifying
Front Surface

3 = 20 mm
 4 = 22 mm
 5 = 24 mm

DS-2304DS-20
 DS-2304DS-22
 DS-2304DS-24



Plain
Magnifying
Front Surface

3 = 20 mm
 4 = 22 mm
 5 = 24 mm

DS-2305DS-20
 DS-2305DS-22
 DS-2305DS-24

Mouth mirror handles — EN
 Mundspiegelgriff — DE
 Manches pour miroirs á bouche — ES



DS-2306DS-01
 4,5 cm/13/4

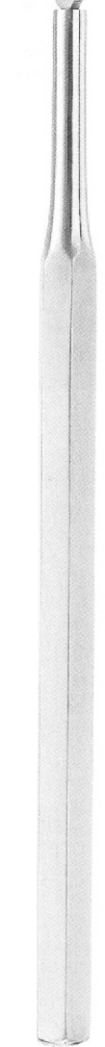

DS-2306DS-02
 Handle only

HILGER
 DS-2306DS-00
 18 cm/7"



DS-2307DS-14
 Hollow

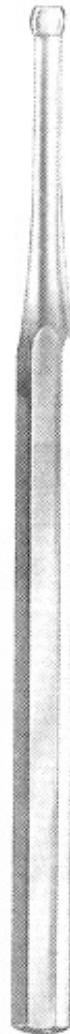

DS-2308DS-14
 Hollow



DS-2309DS-14
 Hollow

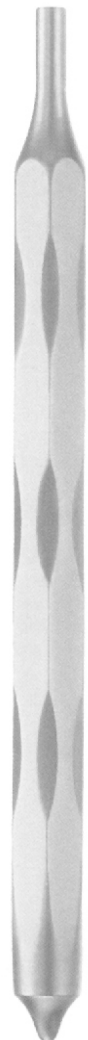

DS-2310DS-14
 Hollow

Mirror handles are available with Cone Socket and Simple Stem Fittings
 Metric / US Threads, Please specify while ordering

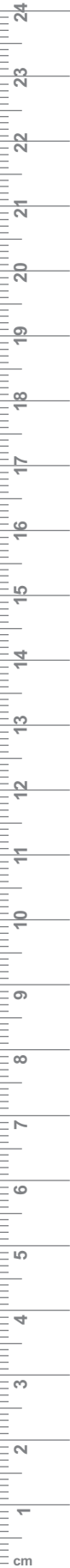



DS-2311DS-12
Hollow



DS-2312DS-12
Solid



DS-2313DS-12
Solid



DS-2314DS-12
Solid



DS-2315DS-00
Solid



DS-2316DS-00
Hollow

Mirror handles are available with Cone Socket and Simple Stem Fittings
 Metric / US Threads, Please specify while ordering



Denis
Surgical

64

- EN** Amalgam Instruments
- DE** Amalgam Instrumente
- ES** Instrumentos de amalgama

Page 116 to 117

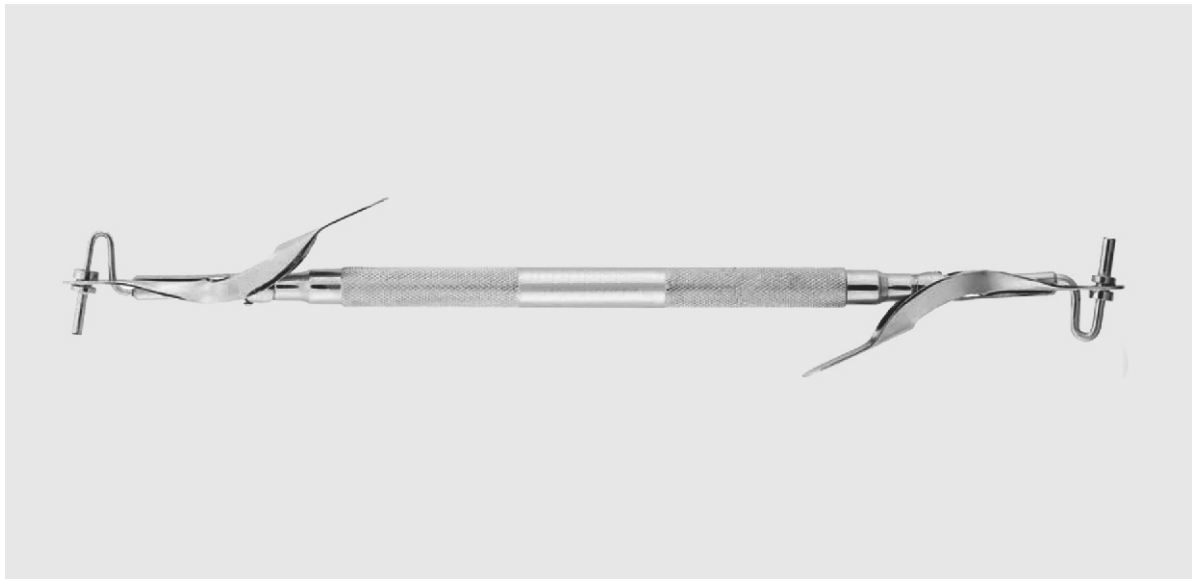

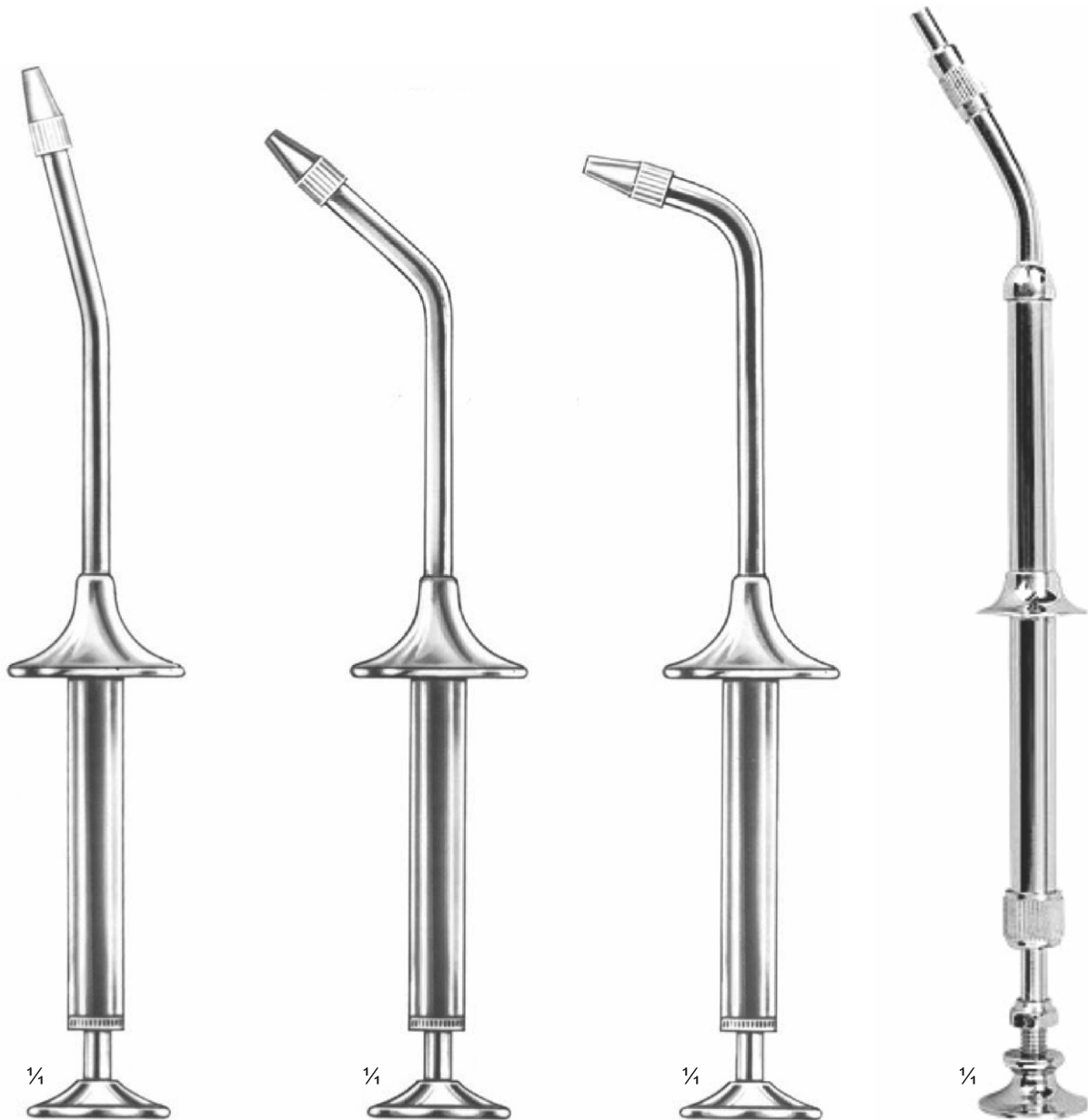

with metal tip
with plastic tip

DS-2351
DS-2352

DS-2353
DS-2354

DS-2355
DS-2356

DS-2357
DS-2358

Amalgam Guns ● EN
 Knochenfeilen ● DE
 Limes à os ● ES

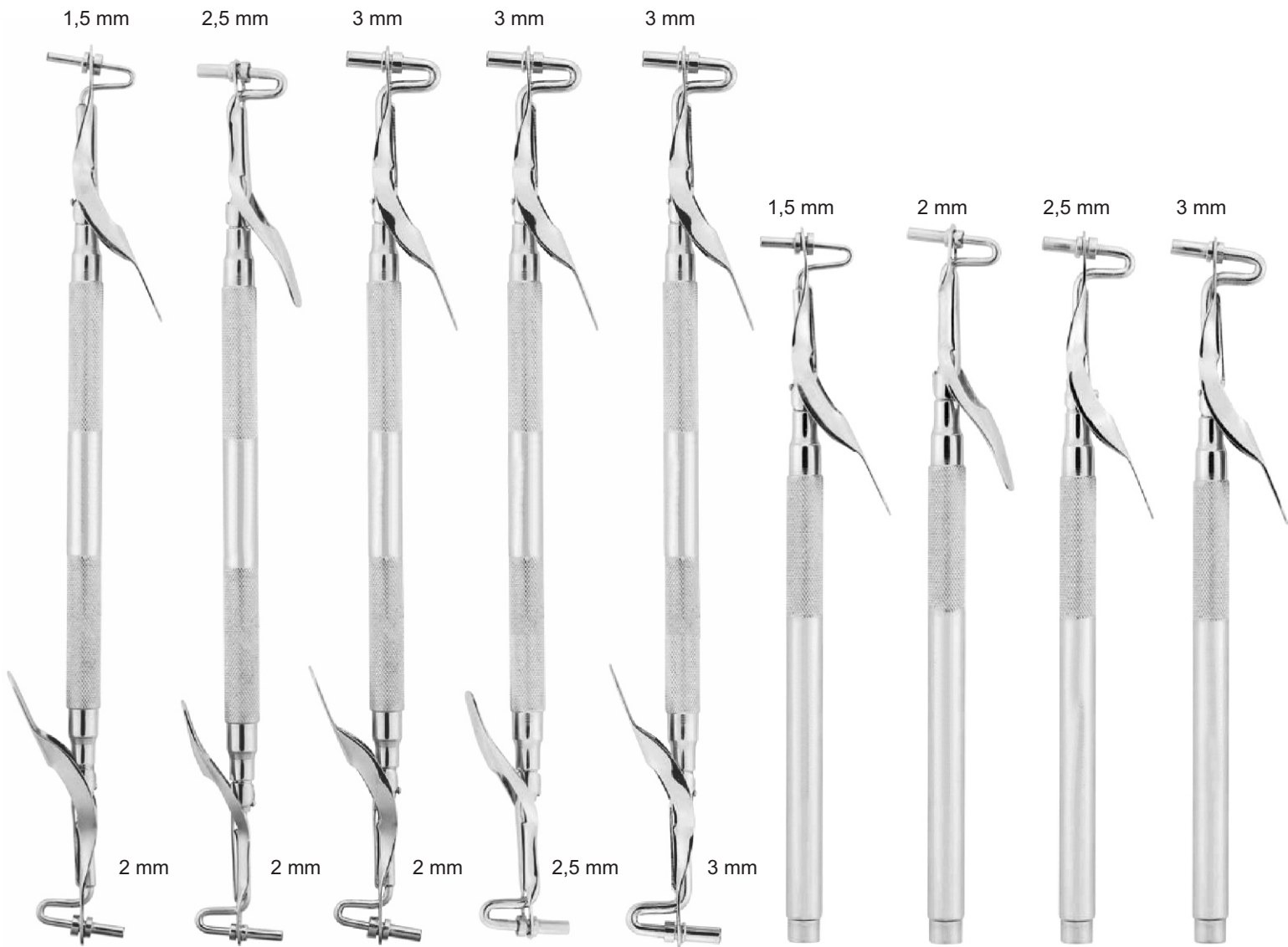

DS-2361
 Medium/small
 20 cm

DS-2362
 Medium/Large
 20 cm

DS-2363
 Medium/Jumbo
 20 cm

DS-2364
 Large/Jumbo
 20 cm

DS-2365
 Jumbo/Jumbo
 20 cm

DS-2366
 small
 15,5 cm

DS-2367
 Medium
 15,5 cm

DS-2368
 Large
 15,5 cm

DS-2369
 Jumbo
 15,5 cm



Denis
Surgical

65

EN

Matrix Retainers

DE

MatrixDS-Halterungen

ES

Retenedores de matrices

Page 118 to 125





TofflemireDS-Universal
DS-2601



TofflemireDS-Senior
DS-2602



TofflemireDS-Junior
DS-2603



Fig.1
Nystrom
left
DS-2604



Fig.2
Nystrom
right
DS-2605



Ivory 8
DS-2606 5 mm
DS-2607 6 mm
DS-2608 7 mm



Ivory 8N
DS-2609



Didner 8P
DS-2610

adjustable

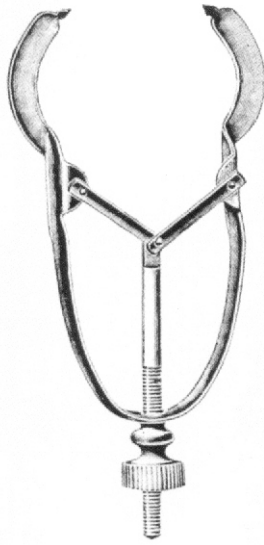

Ivory
DS-2611
Fig. 1

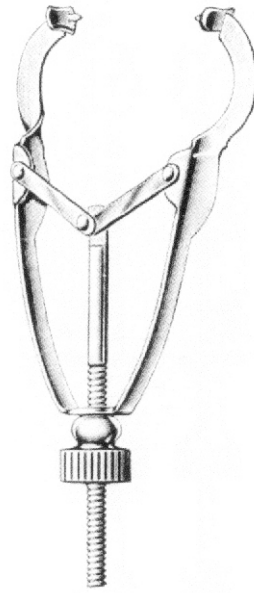

Ivory
DS-2612
Fig. 12



Ivory
DS-2613
Fig. 12A

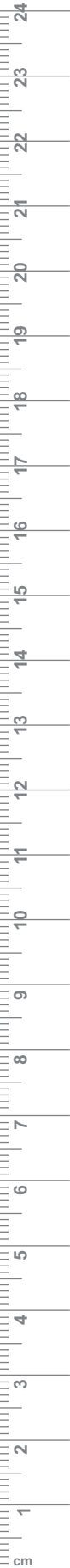



Ainsworth
DS-2614
16 cm / 6 1/2"



Ainsworth
DS-2615
16 cm / 6 1/2"



Ivory
DS-2616
15 cm / 6"



Ivory
DS-2617
15 cm / 6"



Ivory
DS-2618
17 cm / 6 3/4"



Brewer
DS-2619
17 cm / 6 3/4"



Stockes
 DS-2620
 17 cm / 6 3/4"

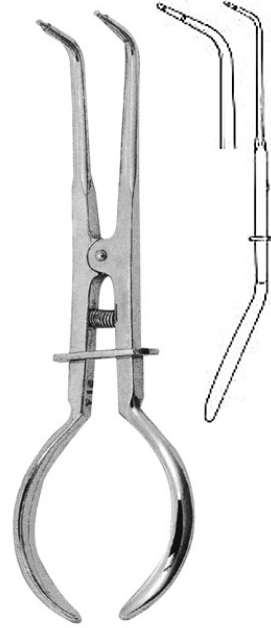

Stockes
 DS-2621
 17 cm / 6 3/4"



Palmer
 DS-2622
 17 cm / 6 3/4"



White
 DS-2623
 17 cm / 6 3/4"



Band Pusher DS-Mershon
 DS-2624
 14 cm / 5 1/2"

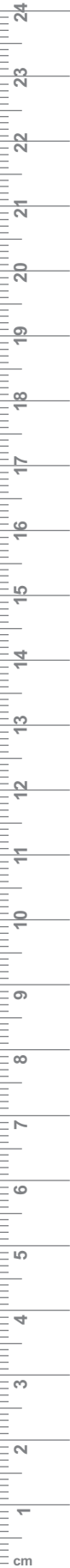



DS-2626
Fig. 00
Anterior Teeth



DS-2627
Fig. 0
Premolars



DS-2628
Fig. 1
Premolars



DS-2629
Fig. 1A
Premolars



DS-2630
Fig. 2
Premolars



DS-2631
Fig. 2A
Premolars



DS-2632
Fig. 2AS
Premolars



DS-2633
Fig. 3
Lower Molars



DS-2634
Fig. 4
Upper Molars



DS-2635
Fig. 5
Upper Molars



DS-2636
Fig. 6
Anterior Teeth



DS-2637
Fig. 7
Lower Molars



DS-2638
Fig. 7A
Lower Molars



DS-2639
Fig. 8
Upper Molars



DS-2640
Fig. 8A
Molars General



DS-2641
Fig. 9
Anterior Teeth



DS-2642
Fig. 9S
Anterior Teeth



DS-2643
Fig. 10
Molars General



DS-2644
Fig. 11
Molars General



DS-2645
Fig. 24
Molars General



DS-2646
Fig. 25
Molars General



DS-2647
Fig. 26
Lower Molars



DS-2648
Fig. 26N
Molars General



DS-2649
Fig. 27
Molars General

Rubber Dam Instruments ● EN
 Knochenfeilen ● DE
 Limes à os ● ES



DS-2650
Fig. 27N
Premolars



DS-2651
Fig. 28
Lower Molars



DS-2652
Fig. 29
Lower Molars



DS-2653
Fig. 30
Upper Molars



DS-2654
Fig. 31
Upper Molars



DS-2655
Fig. 56
Molars General



DS-2656
Fig. 56S
Molars General



DS-2657
Fig. 201
Upper Molars



DS-2658
Fig. 205
Upper Molars



DS-2659
Fig. 212
Anterior Teeth



DS-2660
Fig. 212SA
Anterior Teeth



DS-2661
Premolars
12DS-06DS-W2



DS-2662
Fig. W3
Lower Molars



DS-2663
Fig. W4
Upper Molars



DS-2664
Fig. W7
Lower Molars

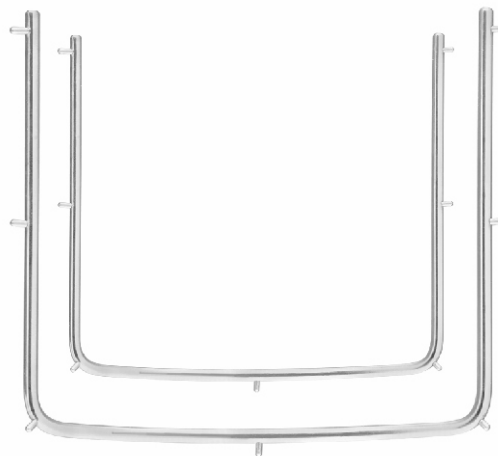

DS-2665 Frame DS- Child
13 cm/5"
DS-2666 Frame DS- Adult
15 cm/6"

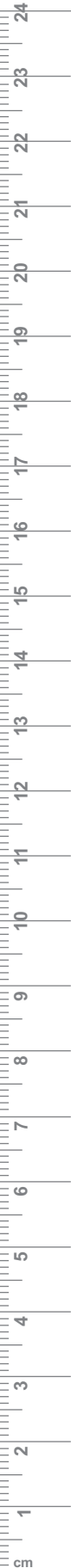

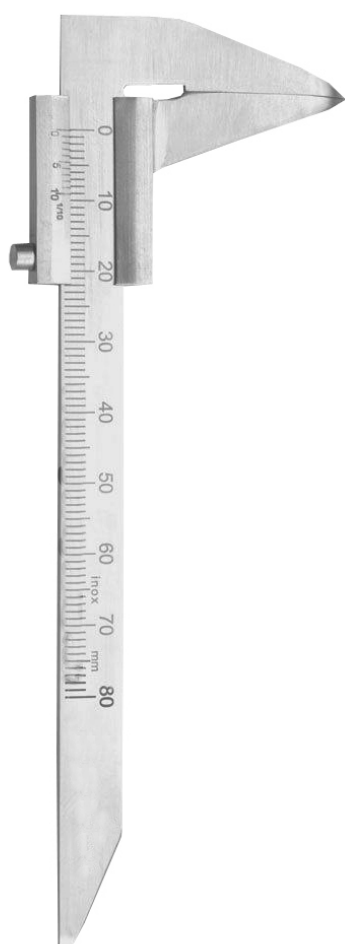

DS-2667
Beerendonk

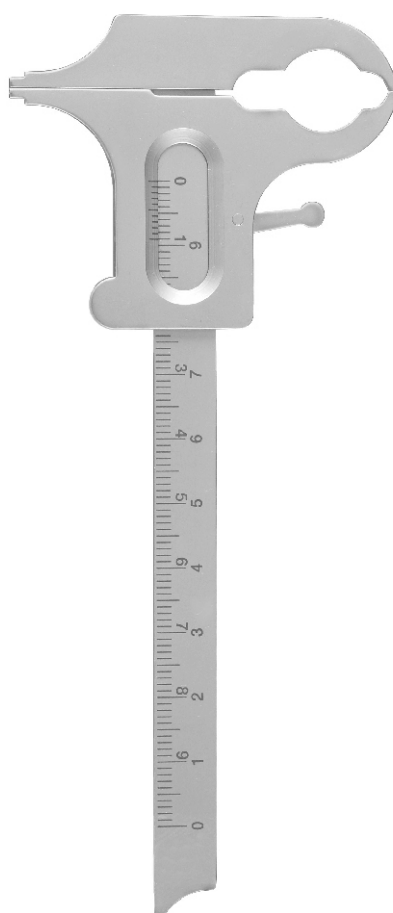

DS-2668
Boley



Iwanson
One side graugation
DS-2669 Metal
DS-2670 Wax

Double side graugation
DS-2671 Metal
DS-2672 Wax

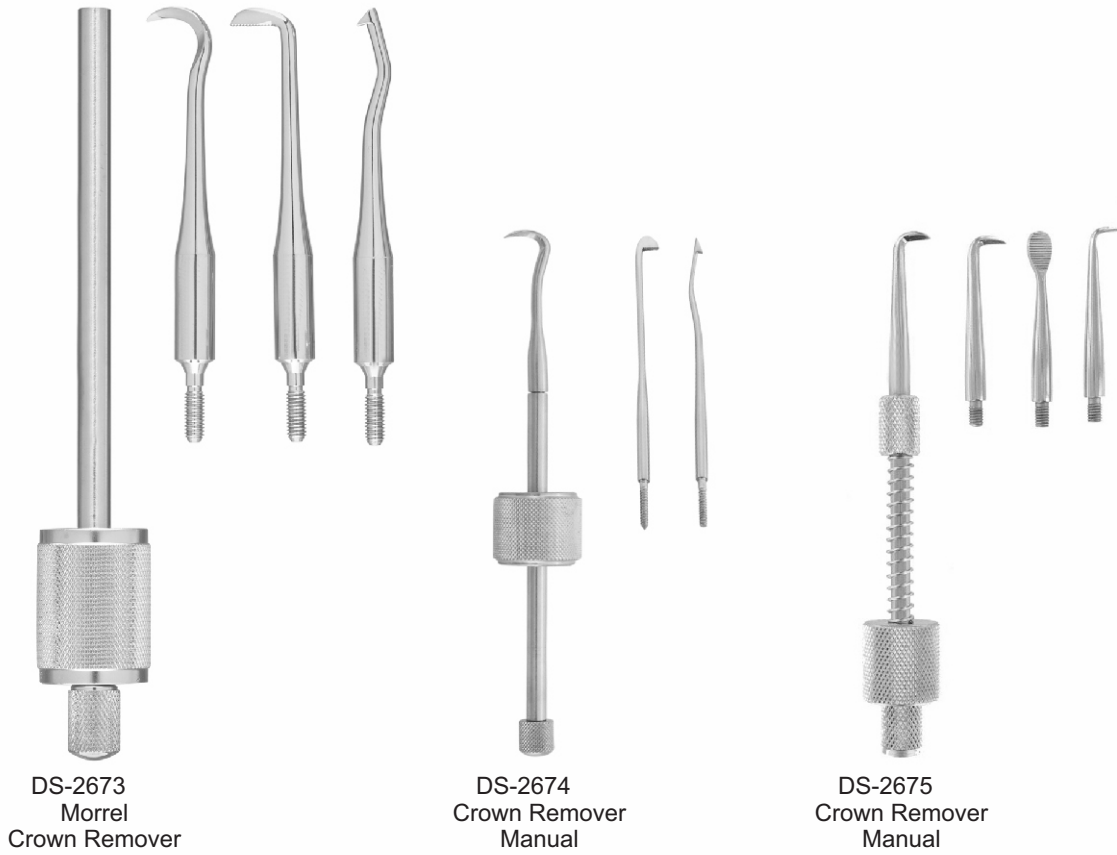



Denis
Surgical

66

- EN** Hemostatic Forceps
- DE** Arterienklemmen
- ES** Pincas hemostaticas

Page 126 to 132





HalstedDS-Mosquito

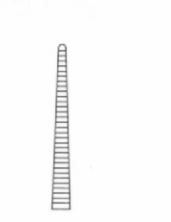

DS-2701
12.5 cm/5"

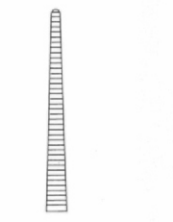

DS-2702
14.5 cm/5 3/4"

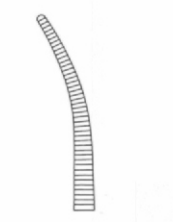

DS-2703
14 cm/5 1/2"

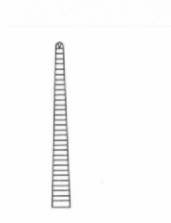

DS-2704
12.5 cm/5"
1:2

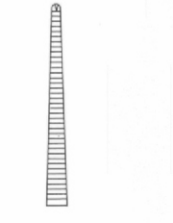

DS-2705
14.5 cm/5 3/4"
1:2

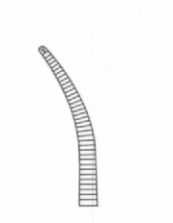

DS-2706
12 cm/4 3/4"
1:2

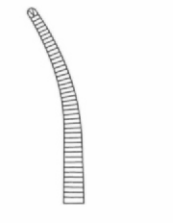

DS-2707
14 cm/4 1/2"
1:2



MicroDS-Mosquito

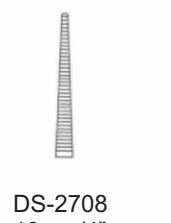

DS-2708
10 cm/4"

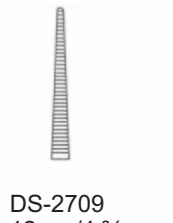

DS-2709
12 cm/4 3/4"

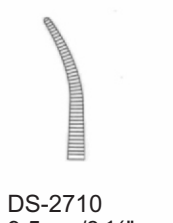

DS-2710
9.5 cm/3 1/2"

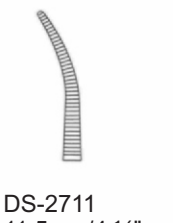

DS-2711
11.5 cm/4 1/2"

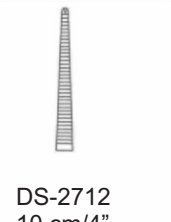

DS-2712
10 cm/4"
1:2

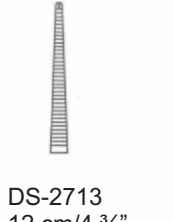

DS-2713
12 cm/4 3/4"
1:2

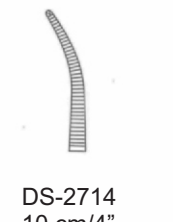

DS-2714
10 cm/4"
1:2

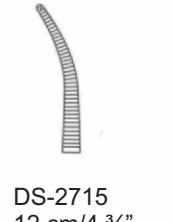

DS-2715
12 cm/4 3/4"
1:2

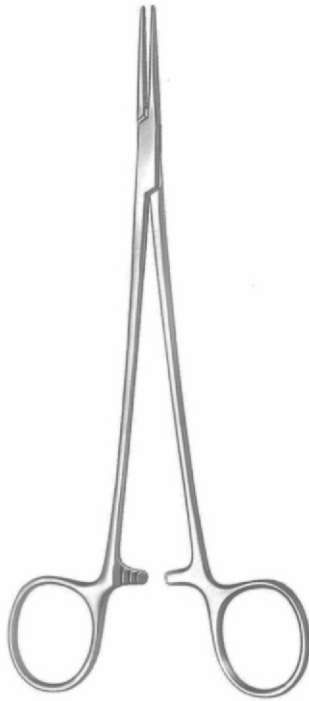

HalstedDS-Mosquito



DS-2716
18 cm/7"

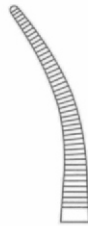

DS-2717
18 cm/7"



DS-2718
18 cm/7"
1:2



DS-2719
18 cm/7"
1:2

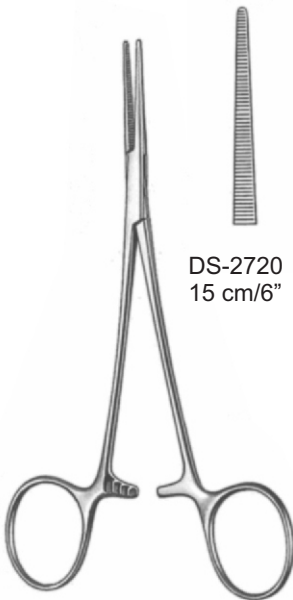

Leriche



DS-2720
15 cm/6"



DS-2721
15 cm/6"



DS-2722
15 cm/6"
1:2

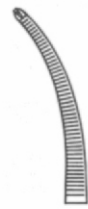

DS-2723
15 cm/6"
1:2

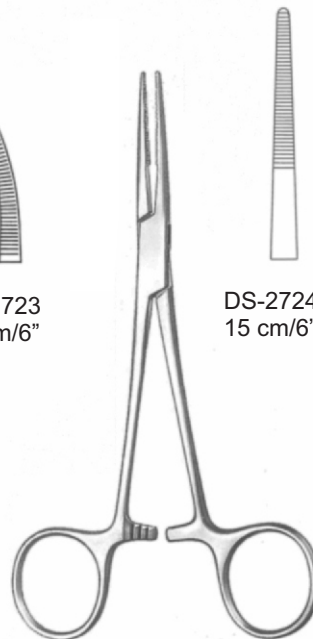

Kelly



DS-2724
15 cm/6"



DS-2725
15 cm/6"



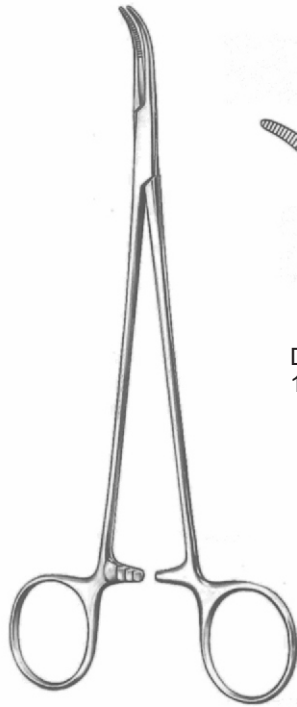

MixerDS-Baby

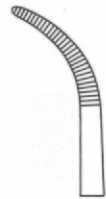

DS-2726
18.5 cm/7 1/4"

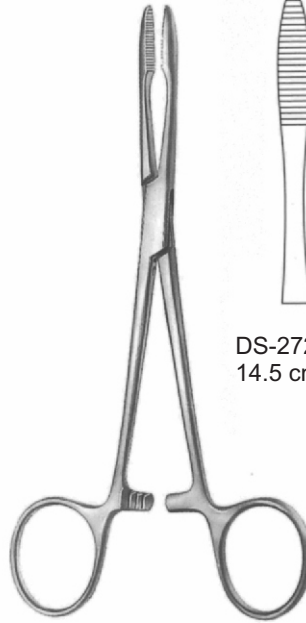

Pean



DS-2727
14.5 cm/5 3/4"



DS-2728
16 cm/6 1/4"



Pean



DS-2729
13 cm/5"



DS-2730
14 cm/5 1/2"



DS-2731
17 cm/6 3/4"



DS-2732
13 cm/5"



DS-2733
14 cm/5 1/2"



DS-2734
17 cm/6 3/4"

Artery Forceps ● EN
 Arterienklemmen ● DE
 Pinzas hemostáticas ● ES

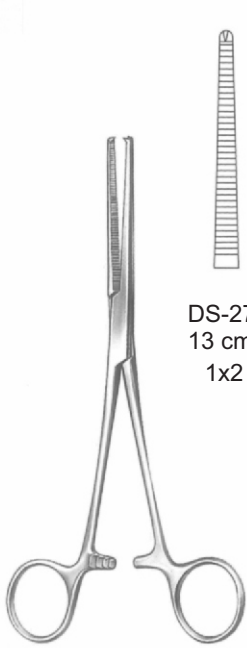

Kocher

DS-2735
 13 cm/5"
 1x2



DS-2736
 14 cm/5 1/2"
 1x2



DS-2737
 13 cm/5"
 1x2



DS-2738
 14 cm/5 1/2"
 1x2

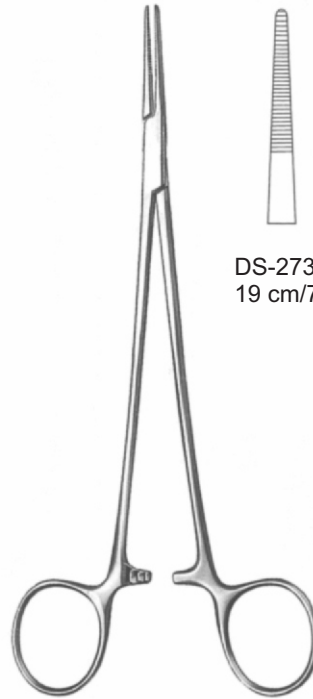

Adson

DS-2739
 19 cm/7 1/2"

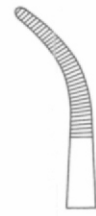

DS-2740
 19 cm/7 1/2"



GrossDS-Maier



DS-2741
 20 cm/8"



DS-2742
 20 cm/8"



DeBakeyDS-Mosquito

ATRAUMA



DS-2743
 12.5 cm/5"



DS-2744
 12.5 cm/5"

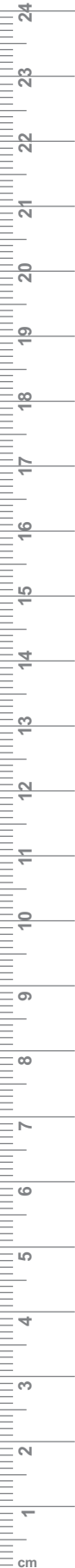



Babcock

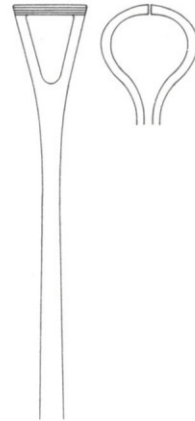

DS-2745 16 cm/6 ¼"
DS-2746 18 cm/7 1/8
DS-2747 20 cm/7 7/8
DS-2748 24 cm/9 ½



Babcock

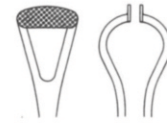

DS-2749 TC
16 cm/6 ½



ATRAUMA

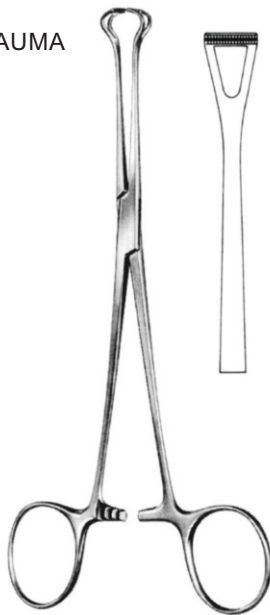

BABCOCK
DS-2750
16 cm/9 ¼

ATRAUMA

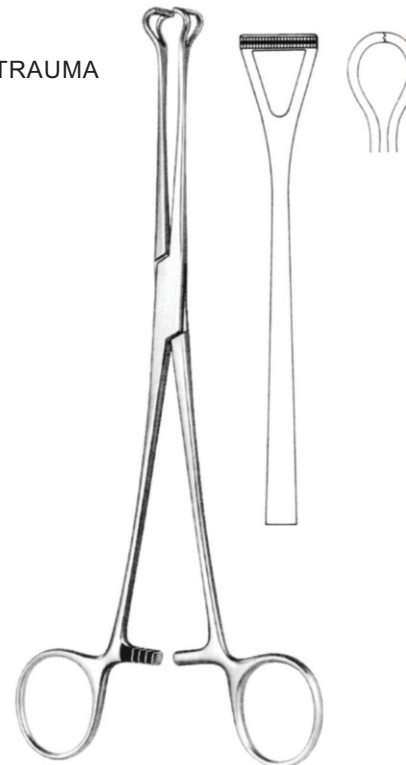

BABCOCK
DS-2751
20.5 cm/8 1/8

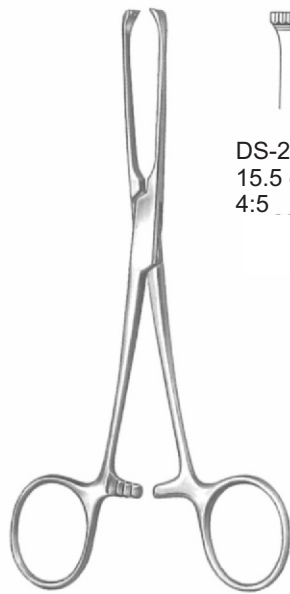

Allis



DS-2752
15.5 cm/6"
4:5



DS-2753
15.5 cm/6"
5:6



DS-2754
19 cm/7 1/2"
5:6

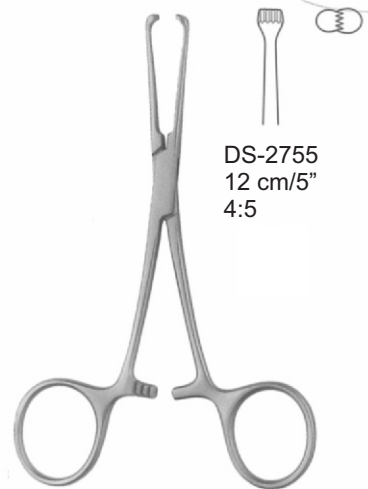

AllisDS-Baby



DS-2755
12 cm/5"
4:5

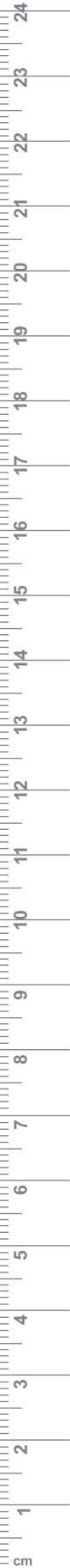

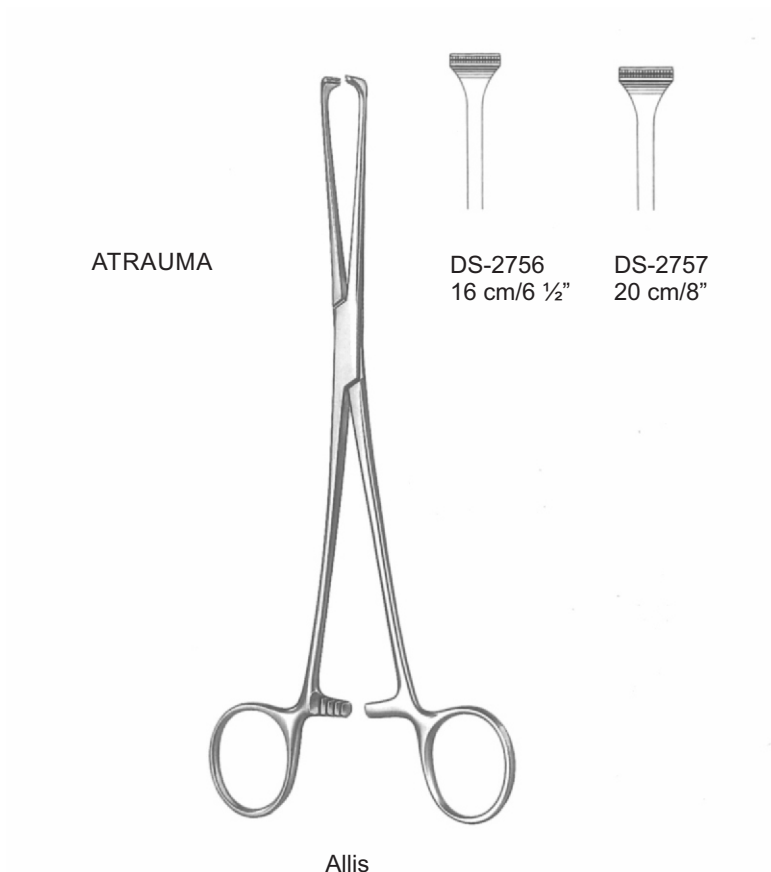

ATRAUMA

DS-2756
16 cm/6 1/2"

DS-2757
20 cm/8"

Allis



Denis
Surgical

67

- EN** Towel Clamps
- DE** Handtuchklammern
- ES** Abrazaderas de toalla

Page 133 to 134

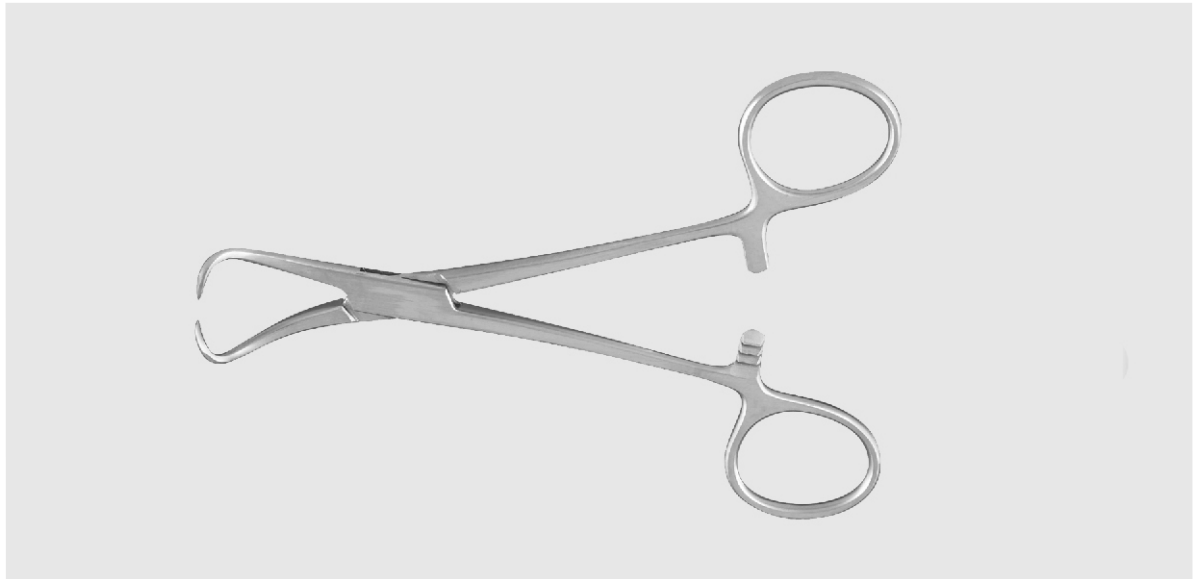

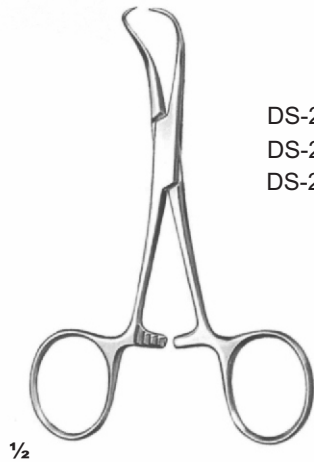

1/2

Backhaus

DS-2801 9 cm/3 1/2"
 DS-2802 11.5 cm/4 1/2"
 DS-2803 13 cm/5"



1/2

for paper clothes

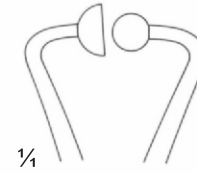

1/4

DS-2804
 11.5 cm/4 1/2"

DS-2805
 14 cm/5 1/2"

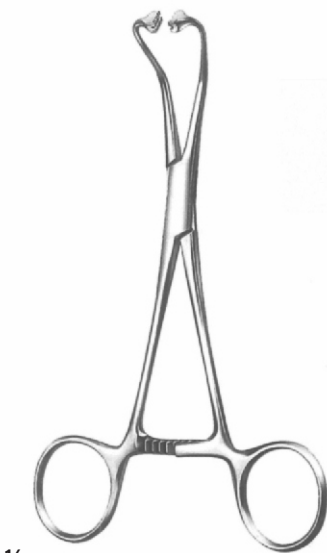

1/2

PeersDS-Bertram
 DS-2806
 14.5 cm/5 3/4"

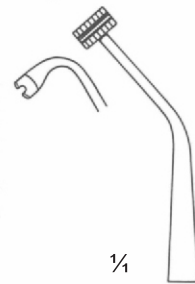

1/4

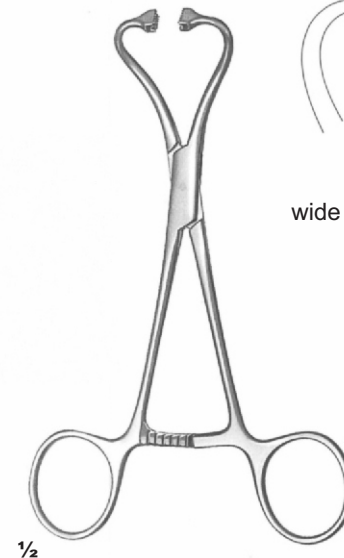

1/2

PeersDS-Bertram modif.
 DS-2807
 15.5 cm/6"

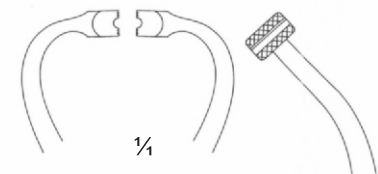

1/4

wide jaw for tube fixation

Towel Clamps — EN
 Handtuchklammern — DE
 Abrazaderas de toalla — ES

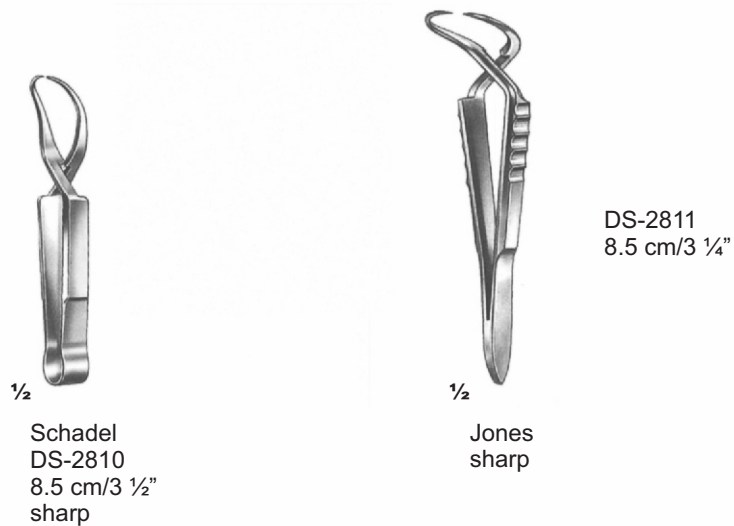
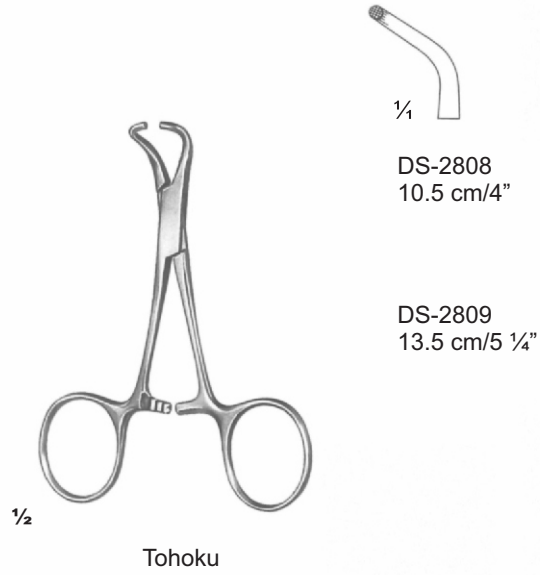



Denis
Surgical

68

EN

Needle Holders

DE

Nadelhalter

ES

PorteDS-aiguilles

Page 135 to 143



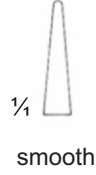

Webster
DS-2901
13 cm/5 1/8"

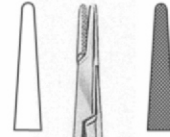
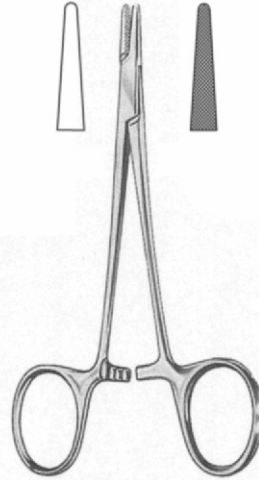

Halsey
DS-2902 13 cm/5 1/8" Plain
DS-2903 13 cm/5 1/8" Serrated



Derf
DS-2904
12 cm/4 3/4"
one feestrated jaw



CrileDS-Wood
DS-2905
15 cm/5 7/8"



CrileDS-Murray
DS-2906
15 cm/5 7/8"
slender pattern

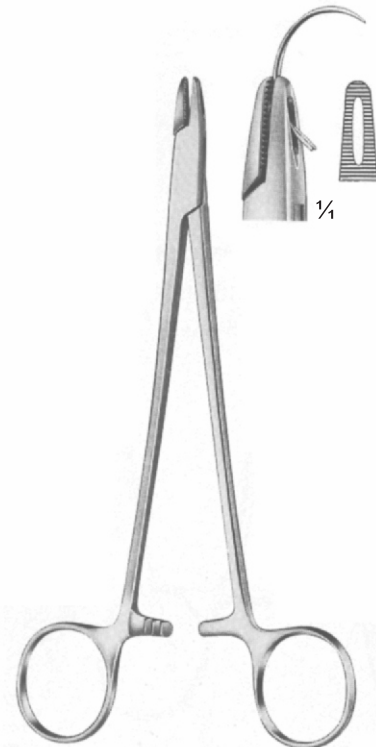

Adson
DS-2907
18 cm/7 1/8"
one fenestrated jaw

- Needle Holders ● EN
- Nadelhalter ● DE
- Porta agujas ● ES

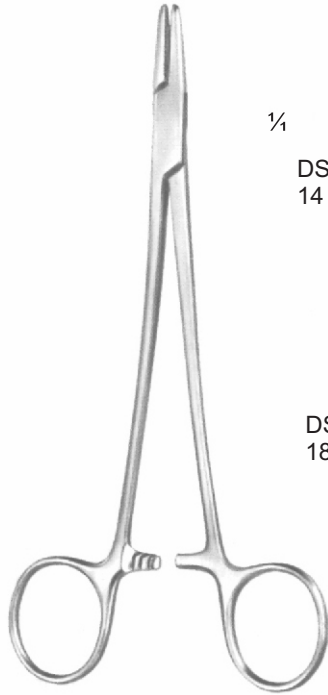

MAYODS-HEGAR

1/4

DS-2908
14 cm/5 1/2"

DS-2909
16 cm/6 1/4"

DS-2910
18.5 cm/7 1/4"

DS-2911
20.5 cm/8 1/8"

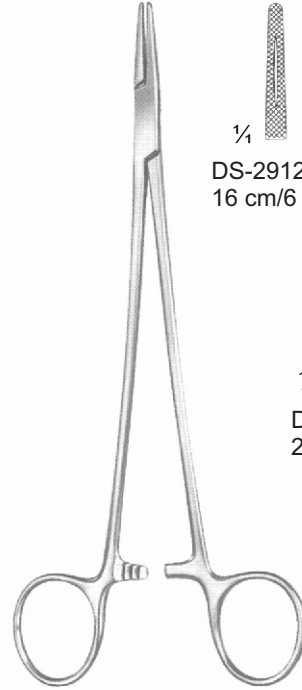

MAYODS-HEGAR
slender pattern

1/4

DS-2912
16 cm/6 1/4"

DS-2913
19 cm/7 1/2"

1/4

DS-2914
20.5 cm/8 1/8"



HEGARDS-BAUMGARTNER
DS-2915
14 cm/5 1/2"



1/4

DS-2916
14 cm/5 1/2"

DS-2917
17 cm/6 3/4"

1/4

DS-2919
14 cm/5 1/2"

DS-2920
17 cm/6 3/4"



MATHIEU

DS-2918
20 cm/7 7/8"

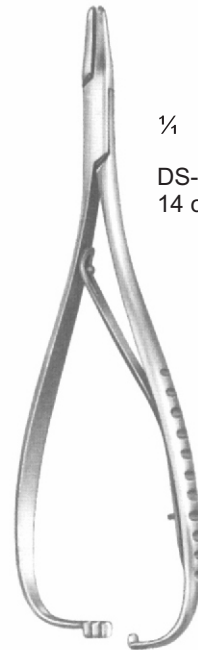

MATHIEU
slender pattern





Lichtenberg
DS-2921
20 cm/7 7/8"



Toennis
DS-2922
18.5 cm/7 1/4"



Crile
DS-2923
15 cm/5 7/8"

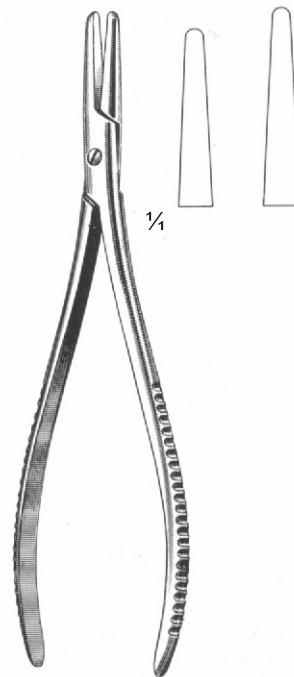

Langenbeck
DS-2924 16 cm/6 1/4"
DS-2925 20 cm/7 7/8"

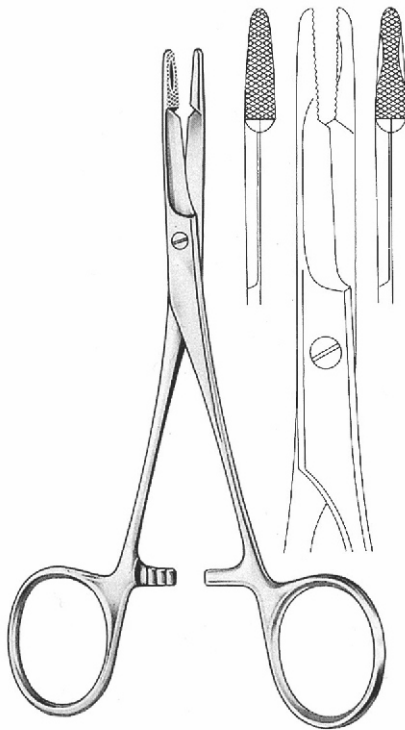

OlsenDS-Hegar

- DS-2926 11 cm/4 3/8"
- DS-2927 14 cm/5 1/2"
- DS-2928 18 cm/7 1/8 "
- DS-2929 19 cm/7 1/2"

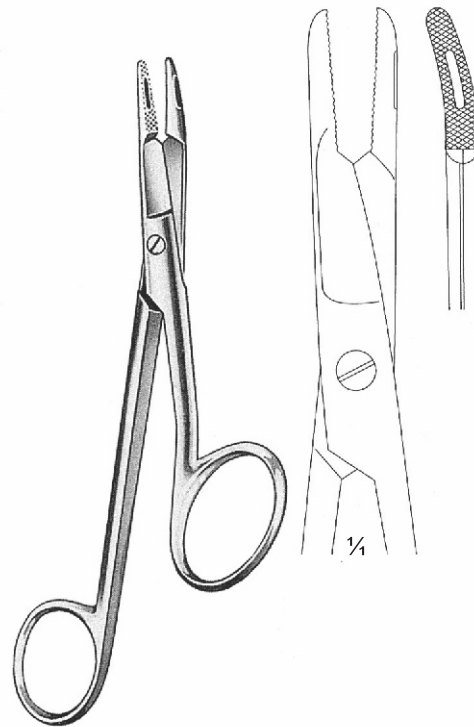

Gillies

- DS-2930 Right hand
- DS-2931 Left hand
- 16 cm/6 1/4"

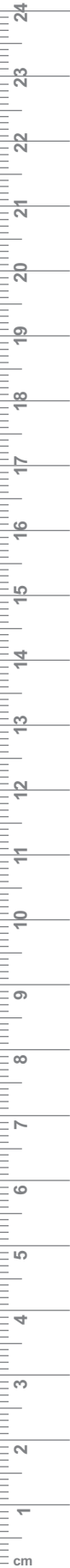



DS-2932
 13 cm/5 1/8
 smooth jaw

HALSEY



DS-2933
 13 cm/5 1/8
 0.4 mm

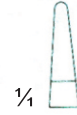

DS-2934
 smooth jaw

WEBSTER
 12.5 cm/4 7/8"



DS-2935
 0.4 mm

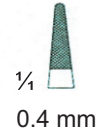

DERF
 DS-2936
 12 cm/4 3/4"



0.5 mm

Toennis
 DS-2937
 18 cm/7 1/8



0.5 mm
 DS-2938
 18.5 cm/7 1/4"



0.5 mm
 DS-2939
 20.5 cm/8 1/8



0.5 mm
 DS-2940
 23 cm/9"

Langenbeck

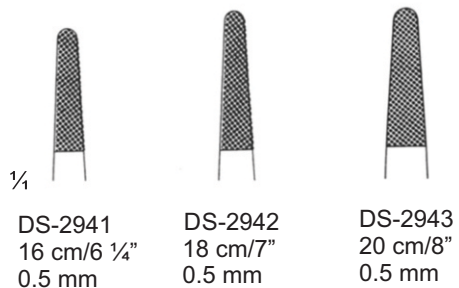
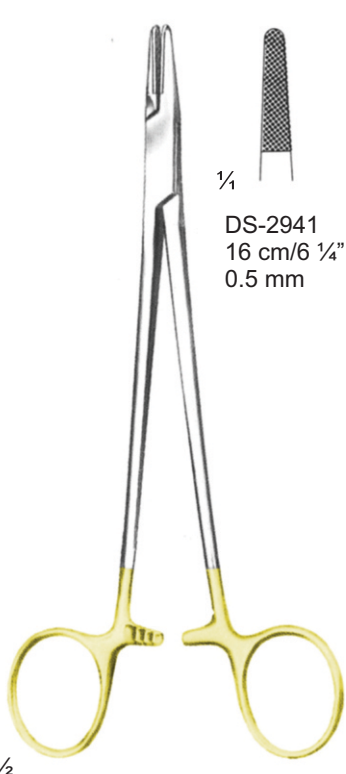

DS-2941 16 cm/6 1/4" 0.5 mm
 DS-2942 18 cm/7" 0.5 mm
 DS-2943 20 cm/8" 0.5 mm

1/2

MayoDS-Hegar standard profile

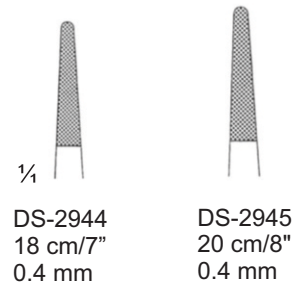
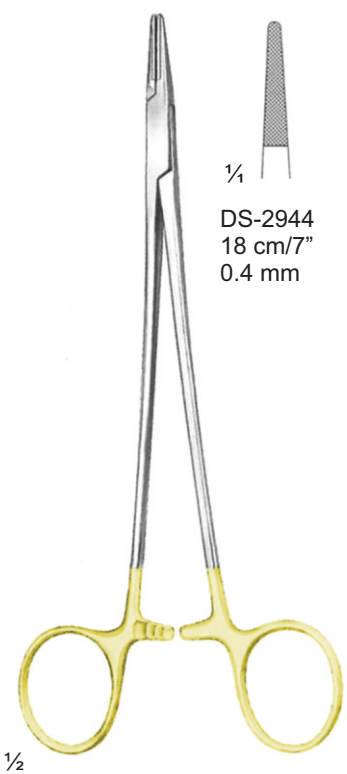

DS-2944 18 cm/7" 0.4 mm
 DS-2945 20 cm/8" 0.4 mm

1/2

Debaquey mini profile

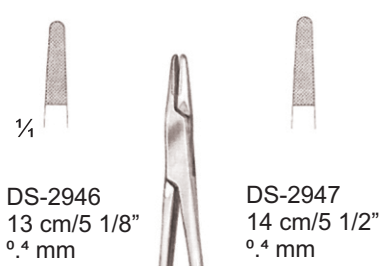

DS-2946 13 cm/5 1/8" 0.4 mm
 DS-2947 14 cm/5 1/2" 0.4 mm

1/2

HEGARDS-BAUMGARTNER

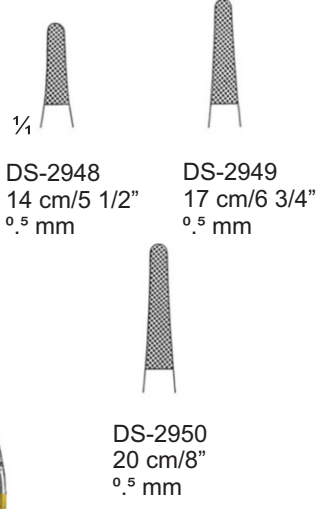

DS-2948 14 cm/5 1/2" 0.5 mm
 DS-2949 17 cm/6 3/4" 0.5 mm
 DS-2950 20 cm/8" 0.5 mm

1/2

Mathieu Standard Profile

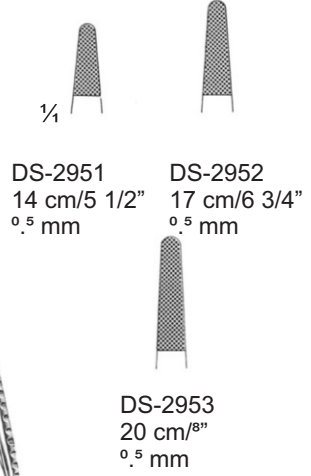
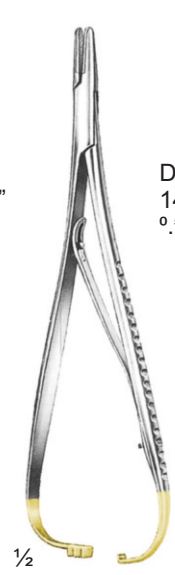

DS-2951 14 cm/5 1/2" 0.5 mm
 DS-2952 17 cm/6 3/4" 0.5 mm
 DS-2953 20 cm/8" 0.5 mm

1/2

Mathieu Standard Profile

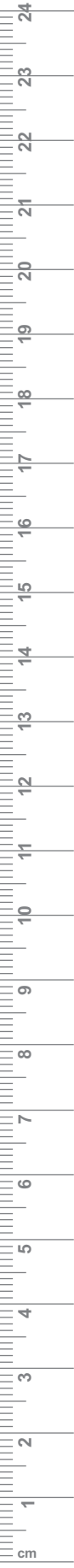



Mathieu

1/4

DS-2954
 17 cm/6 3/4"
 0.5 mm

DS-2955
 20 cm/8"
 0.5 mm

DS-2956
 23 cm/9"
 0.5 mm

with interior ratchet
 standard profile

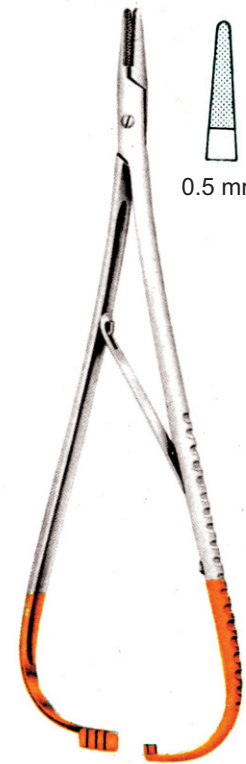

Lichtenberg
 DS-2957
 20 cm/7 7/8"

0.5 mm



Zweifel

1/4

DS-2958
 20.5 cm/8"
 0.5 mm

DS-2959
 23 cm/9"
 0.5 mm

with hinged rehet
 Standard Profile

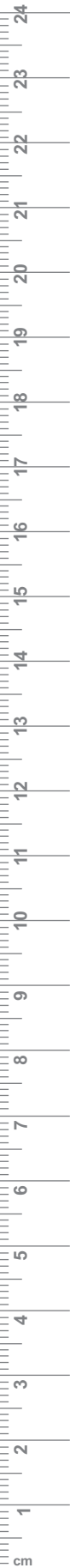
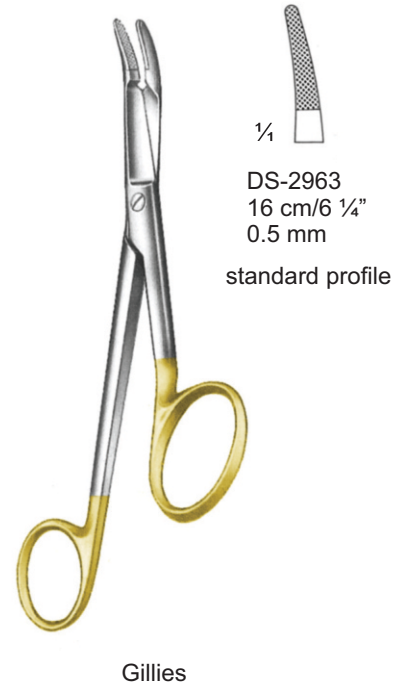
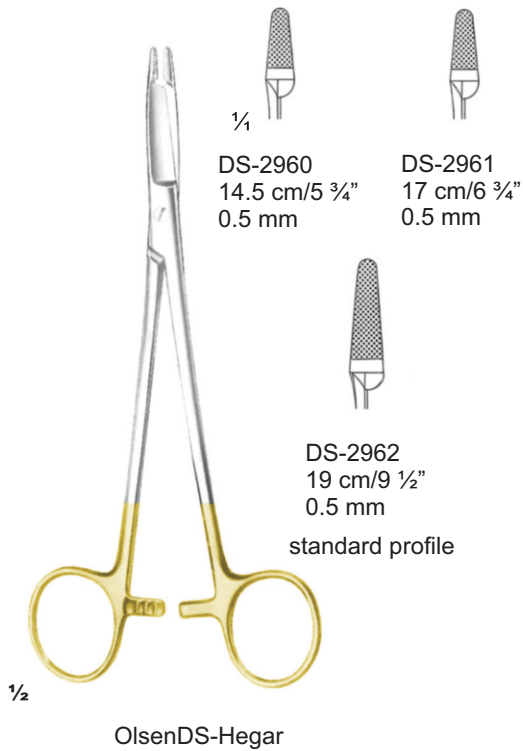

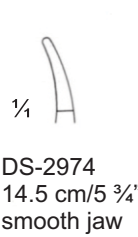
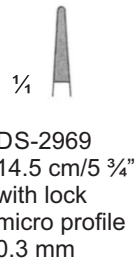
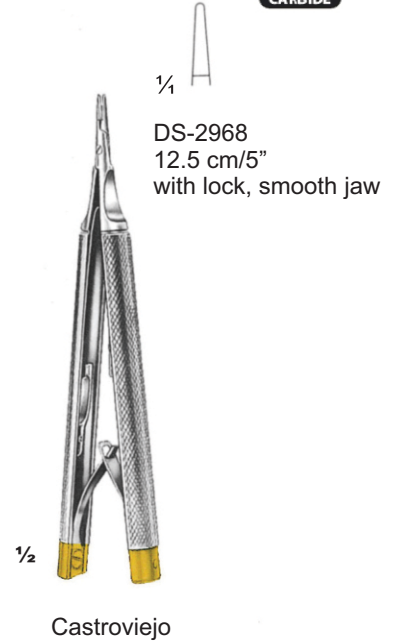
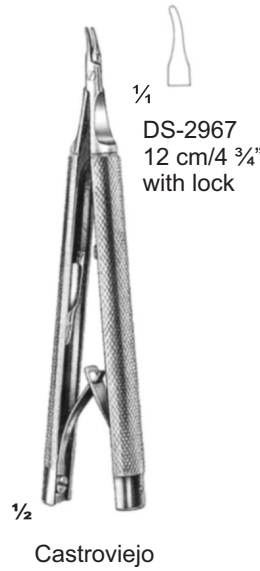
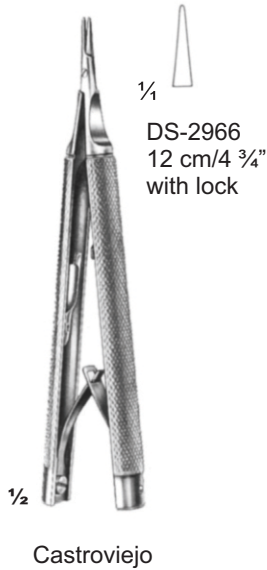



Denis
Surgical

69

- EN** Retractors
- DE** Wundhaken
- ES** Ecarteurs

Page 144 to 148



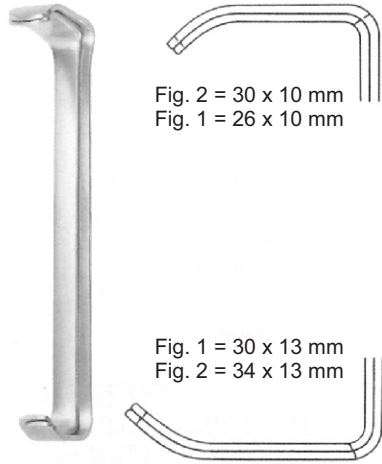

FARABEUF
DS-3001
12 cm/4 3/4"
Fig. 1 DS- 2

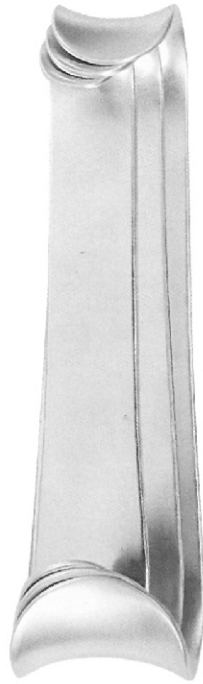

ROUX
DS-3002
Set complete, Fig. 1DS- 3

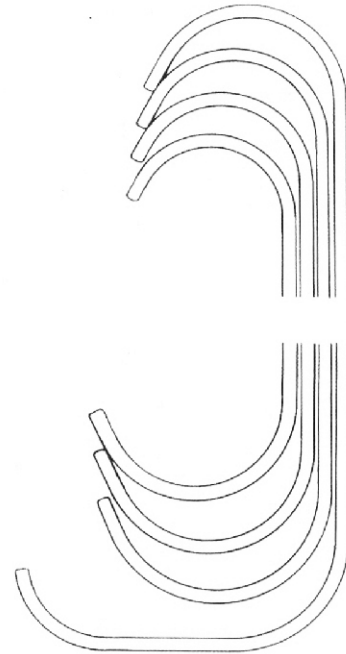
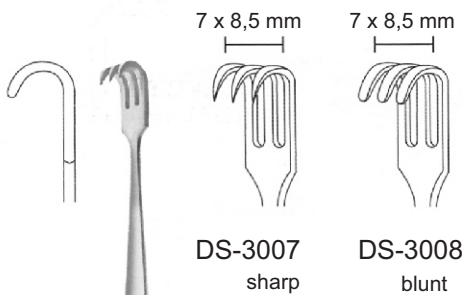

Fig. 1	14 cm/5 1/2"	DS-3003	24 x 20 / 30 x 28
Fig. 2	15 cm/6"	DS-3004	29 x 26 / 36 x 36
Fig. 3	17 cm/6 3/4"	DS-3005	23 x 29 / 38 x 43
Fig. 4	18 cm/7"	DS-3006	29 x 24 / 45 x 28



DS-3007
sharp

DS-3008
blunt

1/2
SENN
17 cm/6 3/4"

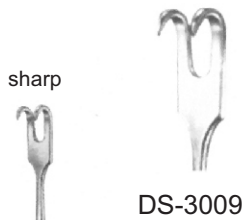

DS-3009



1/2
16 cm/6 1/4" DS-3011



DS-3010

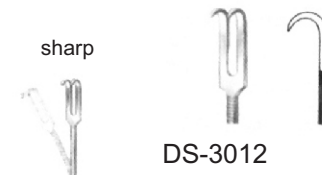

DS-3012



1/2
16 cm/6 1/4" DS-3014



DS-3013



DS-3015
18 cm/7"
Fig. 1

small curvature

DS-3016
18 cm/7"
Fig. 2

large curvature

1/2
GILLIES
18 cm/7"

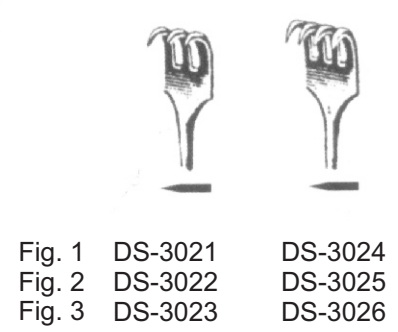
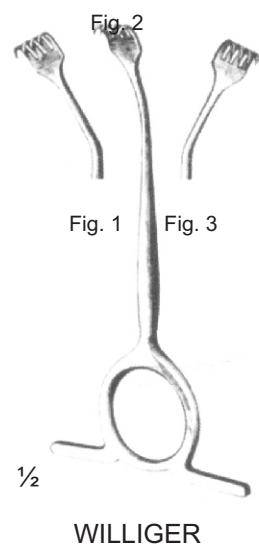
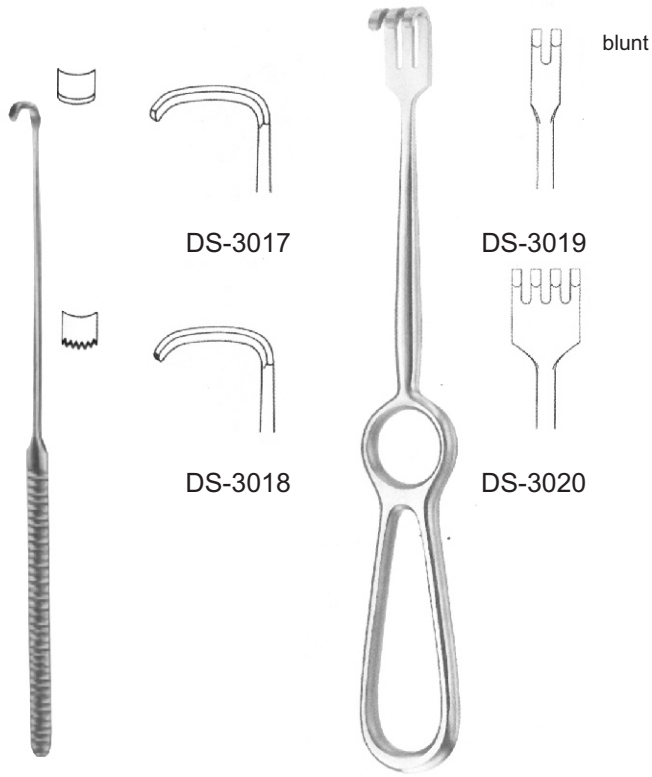

STRANDELLDS-STILLE
 19, cm/7 1/2"

VOLKMANN
 21,5 cm/8 1/2"



LANGENBECK
 22 cm/8 3/4"

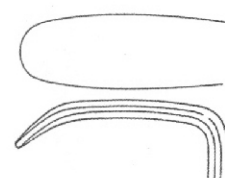

DS-3027
 30x 11 mm

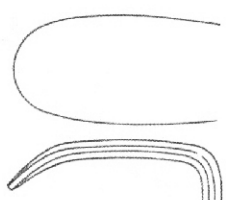

DS-3029
 30x 16 mm

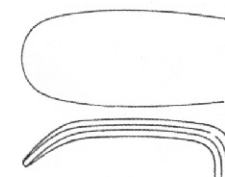

DS-3028
 30x 14 mm

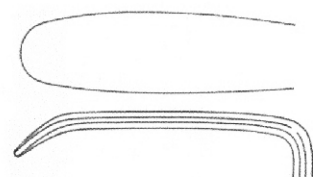

DS-3030
 40x 11 mm

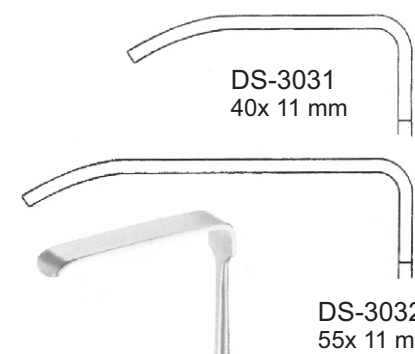

DS-3031
 40x 11 mm

DS-3032
 55x 11 mm



KOCHERDS-LANGENBECK
 22 cm/8 1/2"

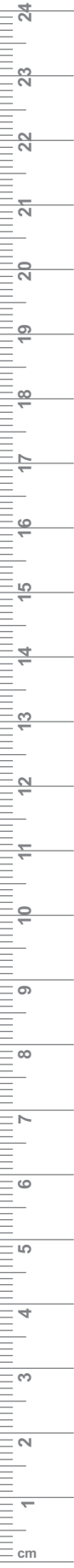



MIDDENDORPF

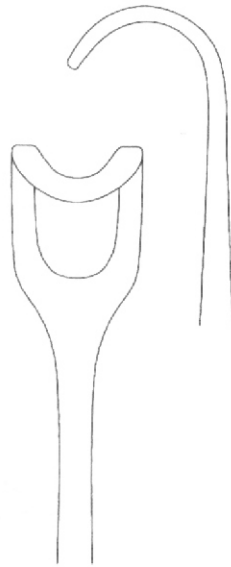

DS-3033
21,5 cm/8 1/2"
14 x 17 mm

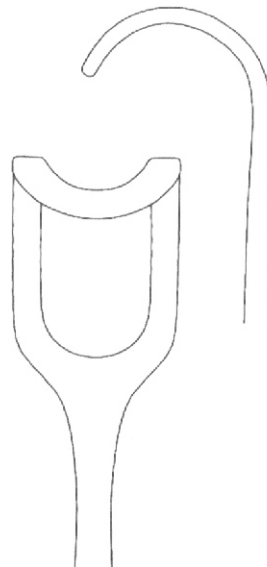

DS-3034
22 cm/8 3/4"
20 x 22 mm



KOCHER LANGENBECK
DS-3035
21 cm/8 1/4"
23 x 8 mm



WARD
DS-3036
15,5 cm/6"



BOWDLER=HENRY
DS-3037
16 cm/6 1/4"



KAY (AUSTIN)
DS-3038

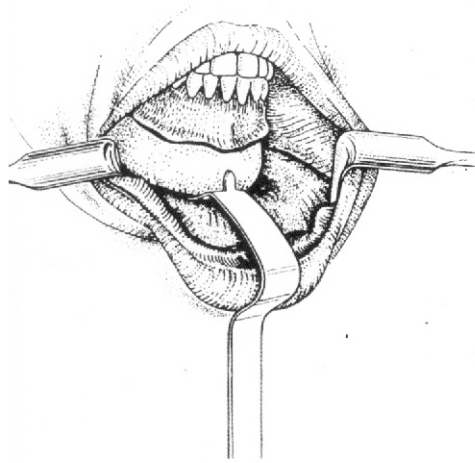

16,5 mm

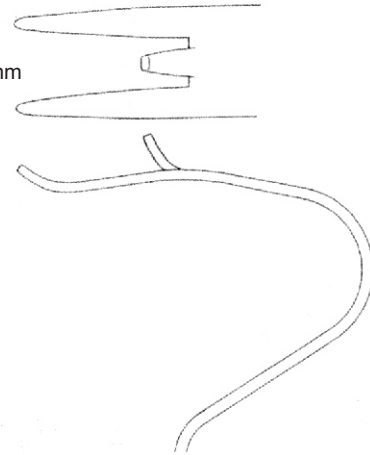

OBWEGESER
 DS-3039
 16 cm/6 1/4"

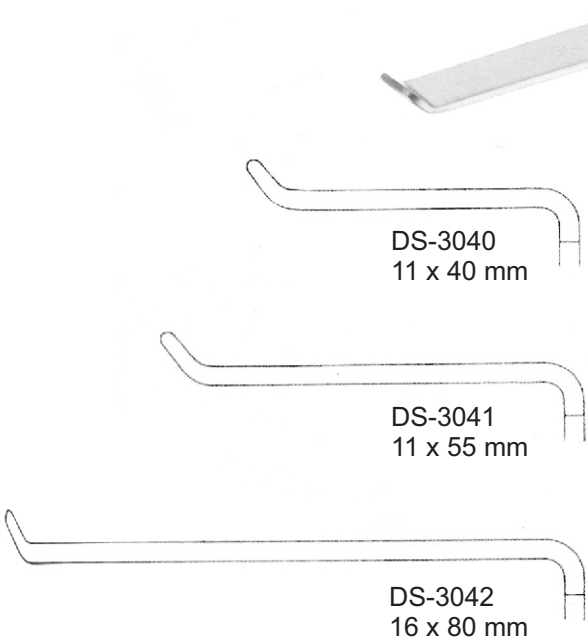

OBWEGESER
 21,5 cm/8 1/2"

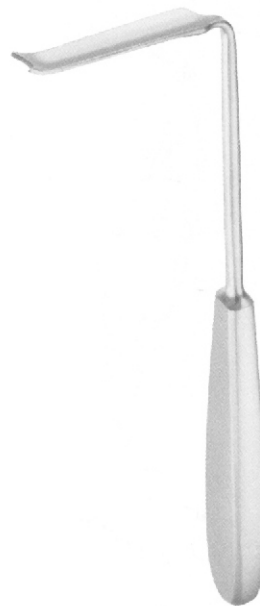

DS-3043
 30 x 9/12 mm

DS-3044
 45 x 9/12 mm

DS-3045
 60 x 9/12 mm

OBWEGESER

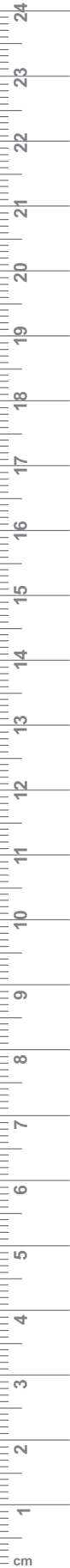



DS-3046
7 cm/2 3/4"
sharp

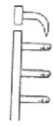

DS-3047
10 cm/4"
sharp

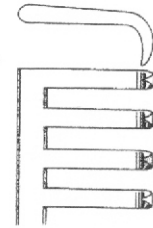
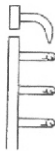

DS-3048
13 cm/4 1/4"
3 : 4
sharp

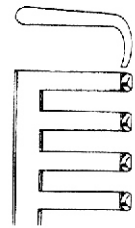

DS-3049
13 cm/4 1/4"
3 : 4
blunt



Denis
Surgical

70

- EN** Mouth and Tongue
- DE** Mund und Zunge
- ES** Boca y la lengua

Page 149 to 152





DOYENDS-JANSEN (MOLT)
 DS-3100 9 cm/3 1/2"
 DS-3101 11 cm/4 1/2"
 DS-3102 14 cm/5 1/2"



DENHARDT
 DS-3103
 12 cm/5"

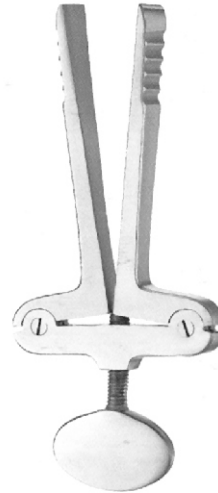

HEISTER
 DS-3104
 13 cm/5 1/4"

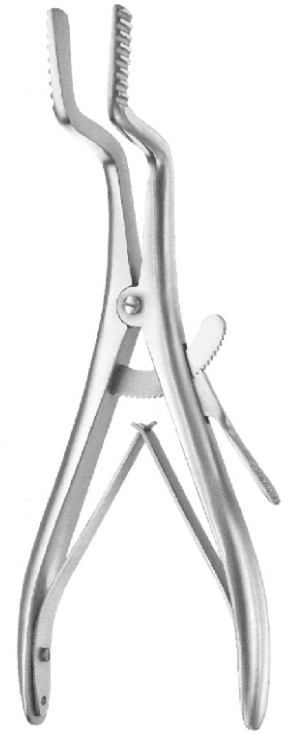

ROSERDS-KOENIG
 16 cm/6 1/4" DS-3105
 19 cm/7 1/2" DS-3106



JENNINGS
 9 cm/3 1/2" DS-3107
 11 cm/4 1/2" DS-3108
 13 cm/5" DS-3109
 15 cm/6" DS-3110

24 x 27 mm



COLLIN
 DS-3111
 16 cm/6 1/2"



YOUNG
 DS-3112
 16 cm/6 1/2"



DS-3113

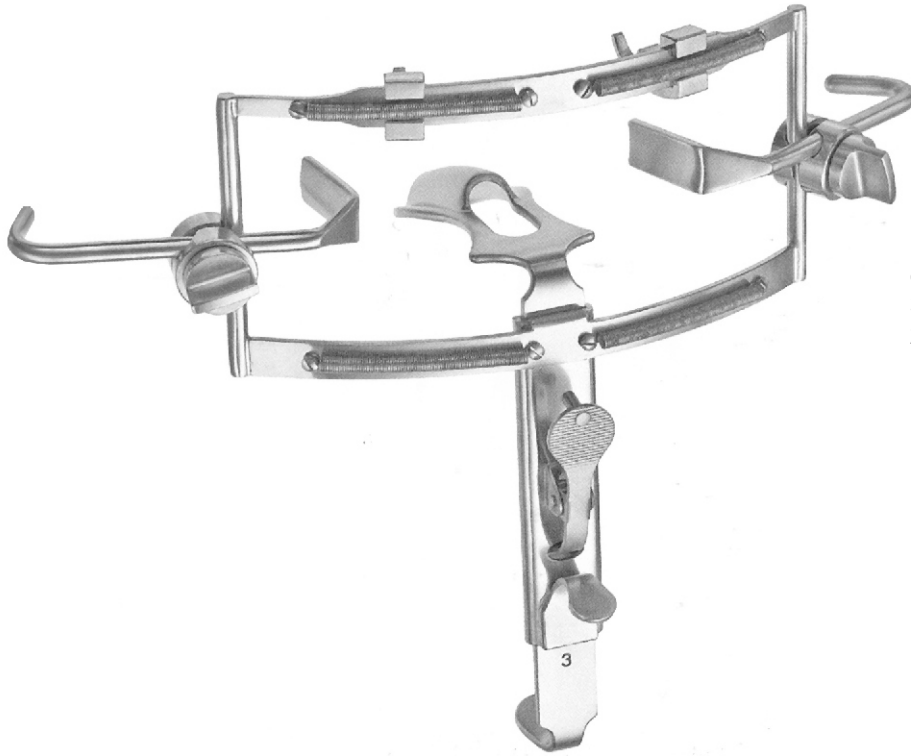

complete with frame,
 3 tongue depressors,
 2 tooth plates

DINGMANN
 DS-3114
 14,5 cm/5 3/4"

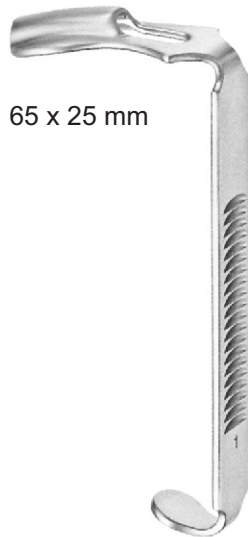

65 x 25 mm

DS-3115
 13,5 cm/5 1/4"



70 x 29 mm

DS-3116
 13,5 cm/5 1/4"

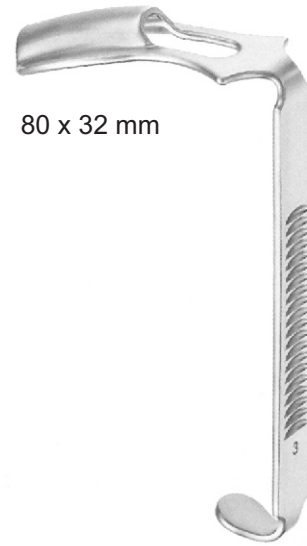

80 x 32 mm

DS-3117
 13,5 cm/5 1/4"

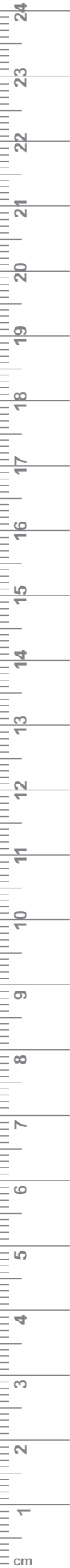



DS-3118
16 cm/6 1/4"

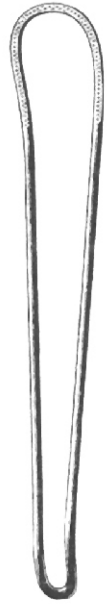

FRENZEL
DS-3119
16,5 cm/6 1/2"

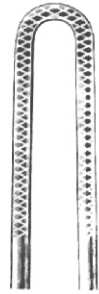

19 / 15 mm



BRUENINGS
DS-3120
19 cm/7 1/2"



BUCHWALD
DS-3121
19 cm/7 1/2"

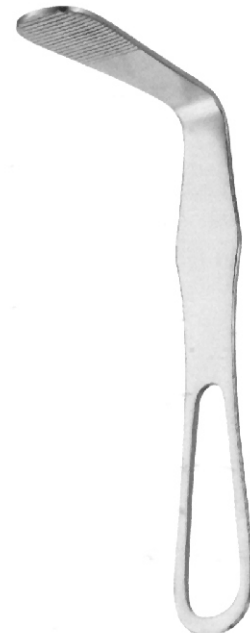

HARTMANN
DS-3122
15 cm/6"

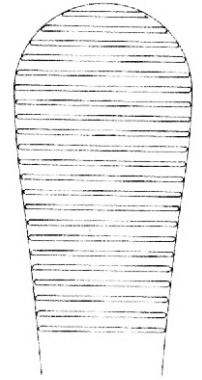

72 X 23 mm



24 / 30 mm

DS-3123
13,5 cm/5 1/4"

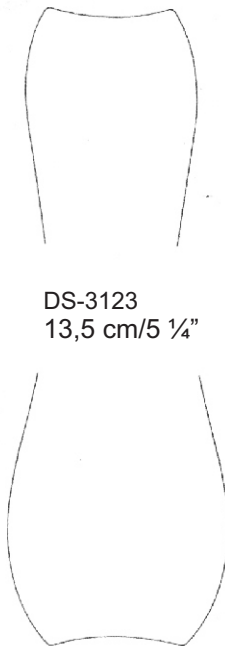

30 / 34 mm

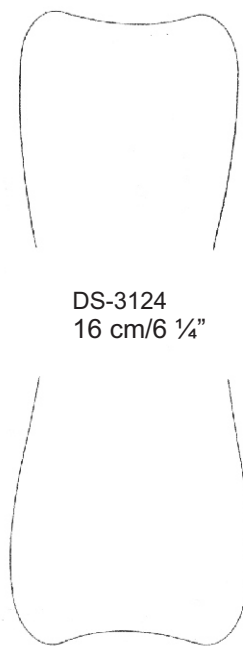

DS-3124
16 cm/6 1/4"



WIEDER

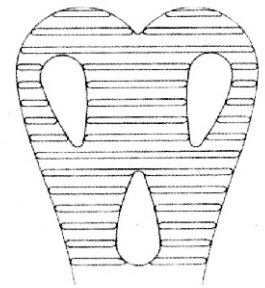

DS-3125
14 cm/5 1/2"
36 mm

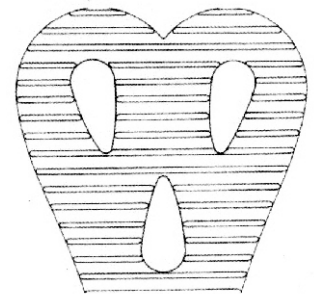

DS-3126
15 cm/6"
43 mm



85 x 24 mm

TOBOLD
DS-3127
14,5 cm/5 3/4"

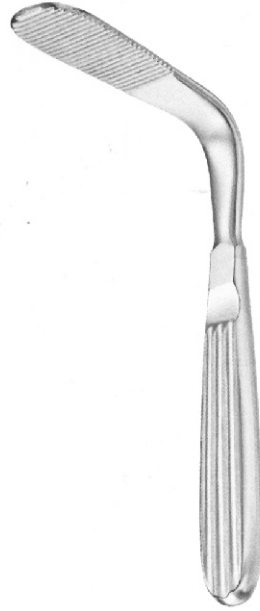

88 x 25 mm

TOBOLD
DS-3128
15 cm/6"



STERNBERG
DS-3129
14 cm/5 1/2"



SIMPLEX
DS-3130
11 cm/4 1/4"



CAWOODDS-MINNESOTA
DS-3131
14 cm/5 1/2"

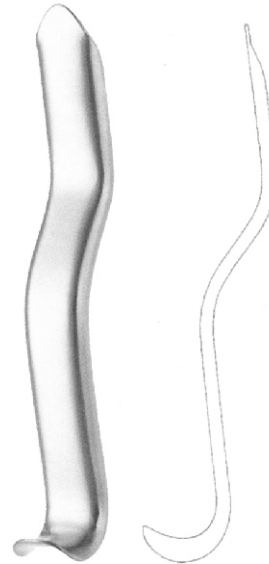

CAWOODDS-MINNESOTA
DS-3132
15 cm/6"
20 mm



DS-3133
19 cm/7 1/2"





Denis
Suegical

71

EN

Scissors

DE

Schere

ES

Tijeras

Page 153 to 171

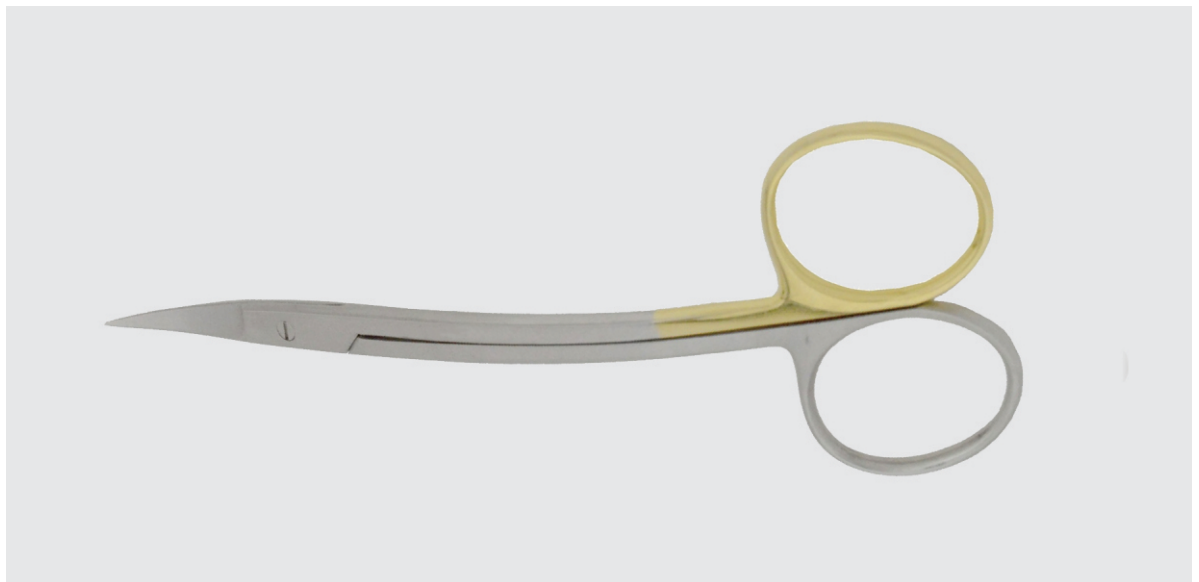

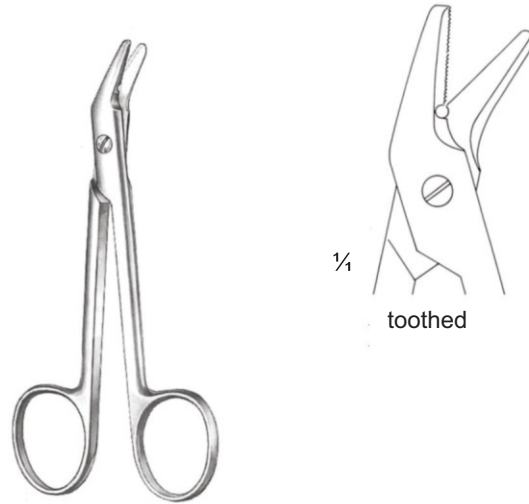

DS-3200
universal
12 cm/4 3/4"



DS-3201 TC
universal
12 cm/4 3/4"

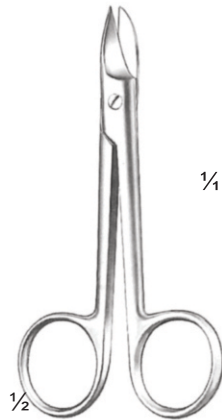
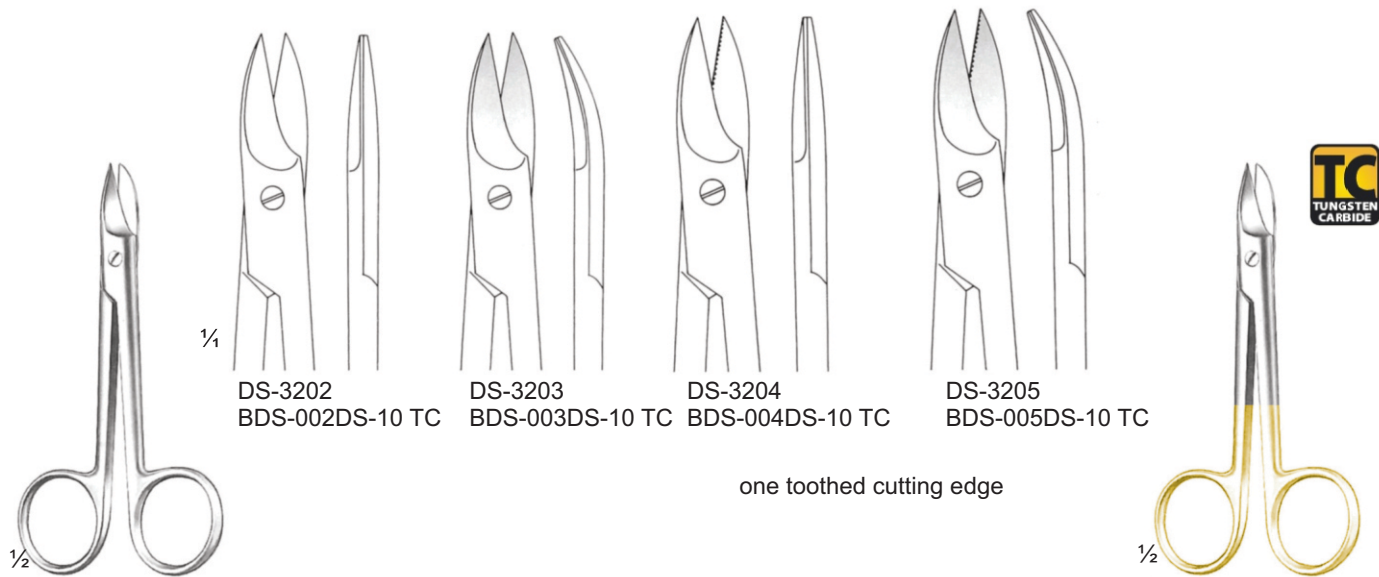

Beebee
10.5 cm/4 1/8"

DS-3202
BDS-002DS-10 TC

DS-3203
BDS-003DS-10 TC

DS-3204
BDS-004DS-10 TC

DS-3205
BDS-005DS-10 TC

one toothed cutting edge

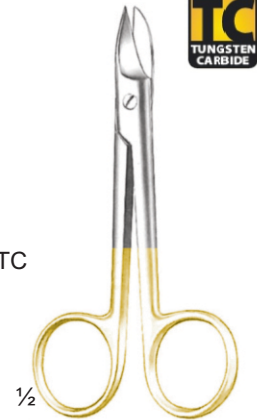

Beebee
10.5 cm/4 1/8"

Wire Cutting Scissors ● EN
 Drahtscheren ● DE
 Tijeras para alambre ● ES



1/2
 Standard
 14.5 cm/5 3/4

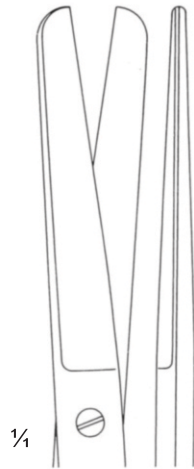

1/4
 DS-3206
 DS-3207 TC



1/4
 DS-3208
 DS-3209 TC



1/4
 DS-3210
 DS-3211 TC



1/2
 Standard
 14.5 cm/5 3/4



1/2
 Standard
 14.5 cm/5 3/4



1/4
 DS-3212
 DS-3213 TC



1/4
 DS-3214
 DS-3215 TC



1/4
 DS-3216
 DS-3217 TC



1/2
 Standard
 14.5 cm/5 3/4





DELICATE

 $\frac{1}{2}$ 14.5 cm/5 $\frac{3}{4}$ "	 $\frac{1}{4}$ DS-3218 DS-3219 TC	 $\frac{1}{4}$ DS-3220 DS-3221 TC	 $\frac{1}{4}$ DS-3222 DS-3223 TC	 $\frac{1}{2}$ 14.5 cm/5 $\frac{3}{4}$ "
 $\frac{1}{2}$ 14.5 cm/5 $\frac{3}{4}$ "	 $\frac{1}{4}$ DS-3224 DS-3225 TC	 $\frac{1}{4}$ DS-3226 DS-3227 TC	 $\frac{1}{4}$ DS-3228 DS-3229 TC	 $\frac{1}{2}$ 14.5 cm/5 $\frac{3}{4}$ "



71

SCISSORS

Wire Cutting Scissors — EN
 Drahtscheren — DE
 Tijeras para alambre — ES

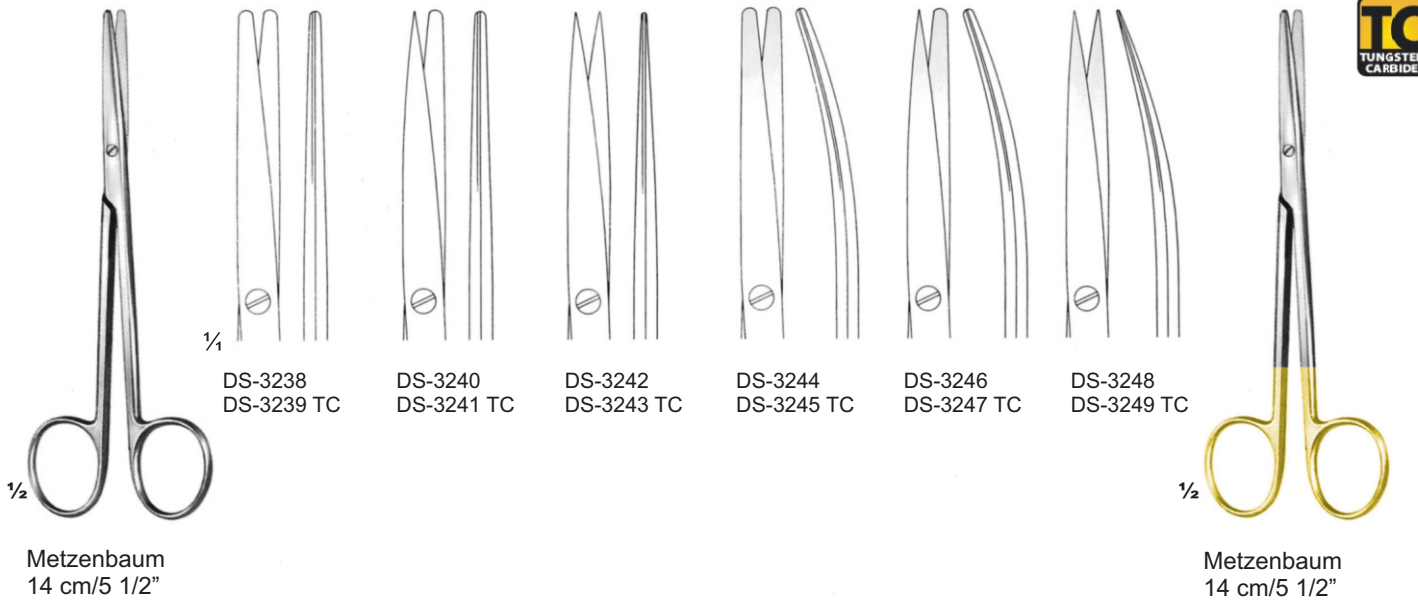



DELICATE



Metzenbaum
15.5 cm/6"



DS-3250
DS-3251 TC



DS-3252
DS-3253 TC



Metzenbaum
15.5 cm/6"



Metzenbaum DS-Nelson
18 cm/7"

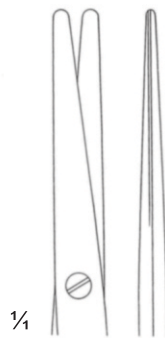

DS-3254
DS-3255 TC



DS-3256
DS-3257 TC



DS-3258
DS-3259 TC



Metzenbaum DS-Nelson
18 cm/7"

Dissecting scissors — EN
 Präparierscheren — DE
 Tijeras de disección — ES

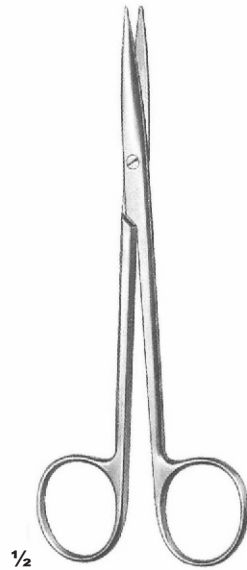

1/2

Metzenbaum
 14.5 cm/5 3/4"

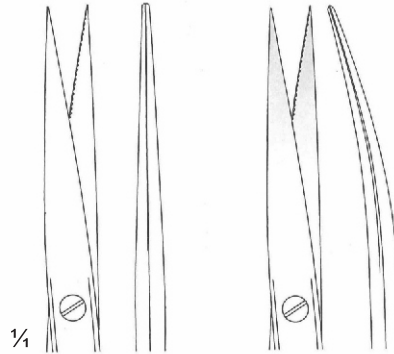

1/4

DS-3260

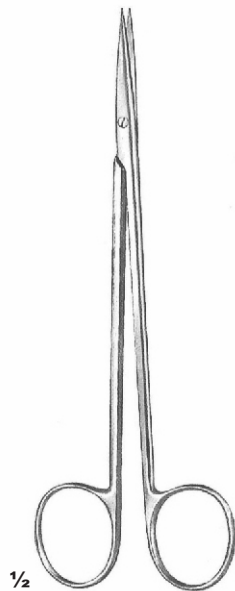

1/2

Nerve dissecting scissors
 15.5 cm/6"

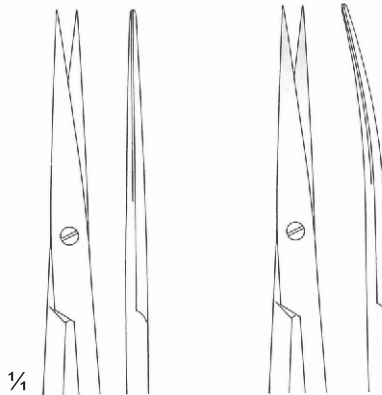

1/4

DS-3262

DS-3263





1/2

LexerDS-Fino
slender pattern
16.5 cm/6 1/2"

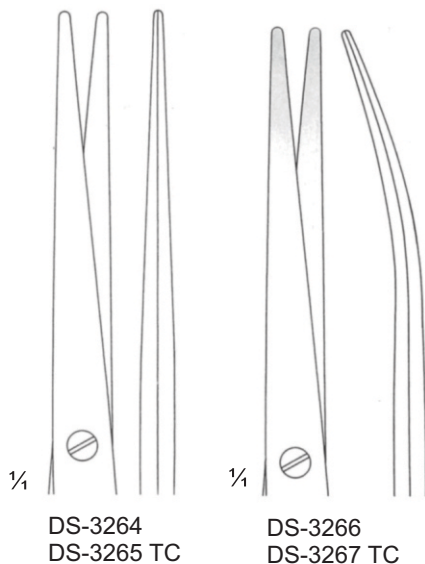

1/4

DS-3264
DS-3265 TC

1/4

DS-3266
DS-3267 TC



1/2

LexerDS-Fino
slender pattern
16.5 cm/6 1/2"

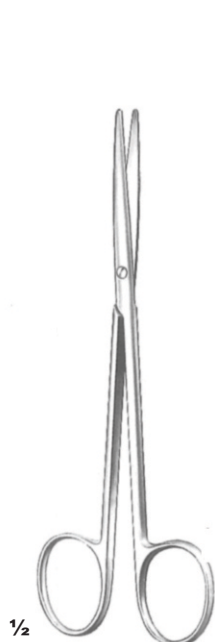

1/2

MetzenbaumDS-Fino
slender pattern
14.5 cm/5 3/4"

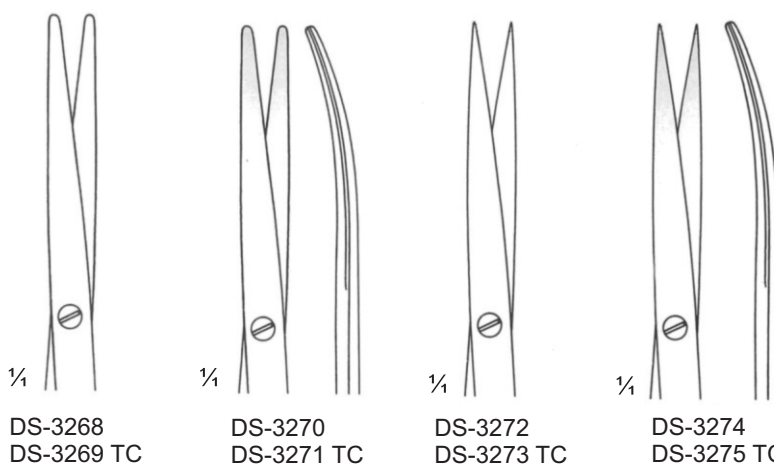

1/4

DS-3268
DS-3269 TC

1/4

DS-3270
DS-3271 TC

1/4

DS-3272
DS-3273 TC

1/4

DS-3274
DS-3275 TC

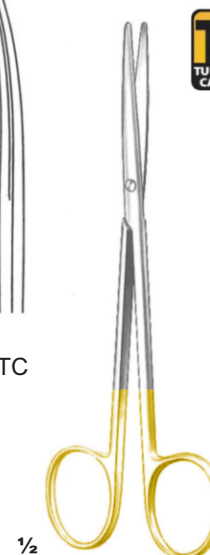

1/2

MetzenbaumDS-Fino
slender pattern
14.5 cm/5 3/4"





MetzenbaumDS-Fino
slender pattern
18 cm/7"

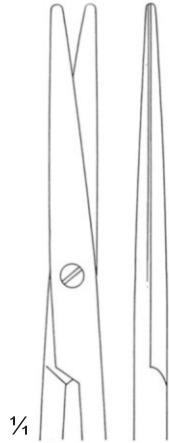

DS-3276
DS-3277 TC



DS-3278
DS-3279 TC



MetzenbaumDS-Fino
slender pattern
18 cm/7"

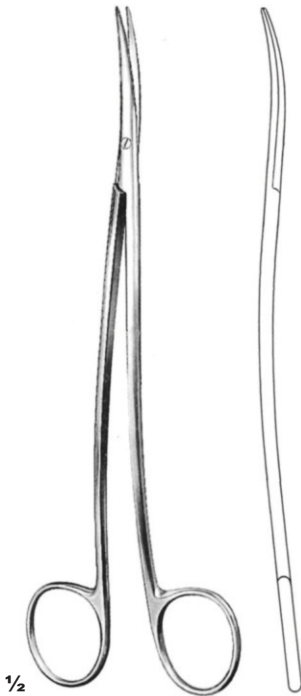

MetzenbaumDS-Fino
S shaped
18 cm/7"



DS-3280
DS-3281 TC



MetzenbaumDS-Fino
S shaped
18 cm/7"



DS-3282
12.5 cm/5"

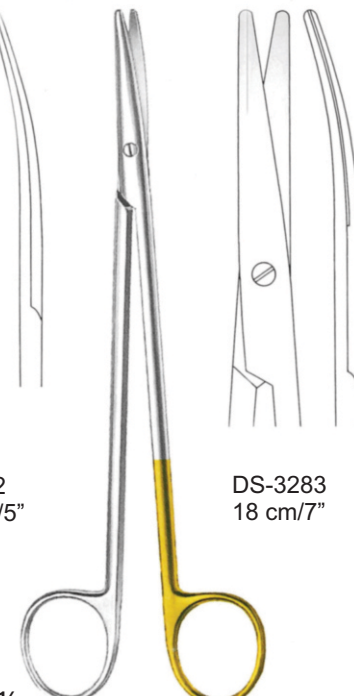

Salyer
fine model for cleft palate



DS-3283
18 cm/7"

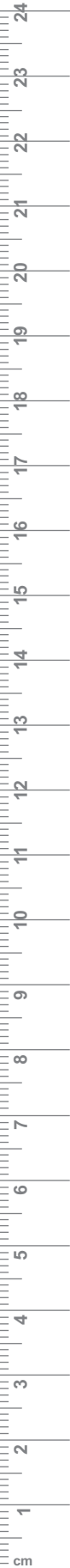

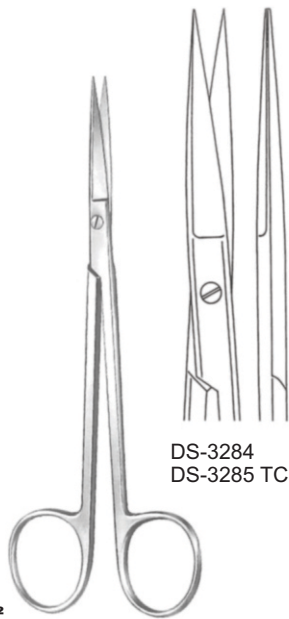

DS-3284
DS-3285 TC

1/2

Sanvenero
14 cm/5 1/8"



DS-3286
DS-3287 TC

1/2

Sanvenero
14 cm/5 1/8"



DS-3288
DS-3289 TC

1/2

Joseph
14.5 cm/5 3/4"



DS-3290
DS-3291 TC

1/2

Joseph
14.5 cm/5 3/4"

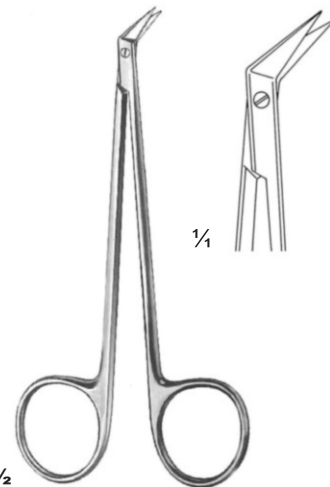

DiethrichDS-Salyer
DS-3292
12 cm/4 3/4"

1/2



DS-3293
angled upwards

1/4



Dean
17.5 cm/7"

1/2



DS-3294
toothed, angled upwards

1/4

Gum scissors, operating scissors — EN
 Zahnfleischscheren, chirurgische scheren — DE
 Tijeras para encías, Tijeras quirúrgicas — ES

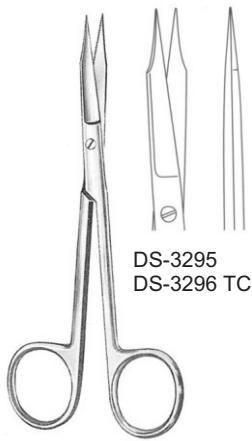

DS-3295
DS-3296 TC

GOLDMANNDS-FOX
13 cm/5 1/8"



DS-3297
DS-3298 TC



GOLDMANNDS-FOX
13 cm/5 1/8"

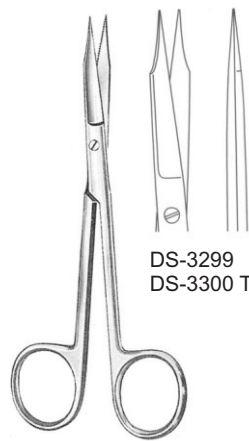

DS-3299
DS-3300 TC

GOLDMANNDS-FOX
13 cm/5 1/8"

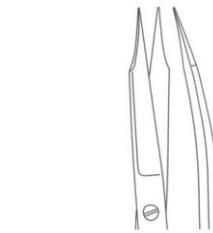

DS-3301
DS-3302 TC

Toothed Blades



GOLDMANNDS-FOX
13 cm/5 1/8"



1/4

DS-3303

Small modle
12 cm/4 3/4"



DS-3304



DS-3305

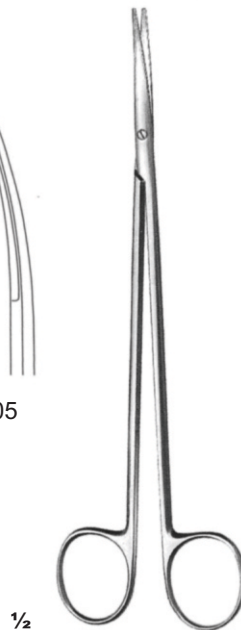

1/2

ToennisDS-Adson
17.5 cm/7"



1/4

slender pattern
DS-3306
DS-3307 TC



1/2

ToennisDS-Adson
17.5 cm/7"

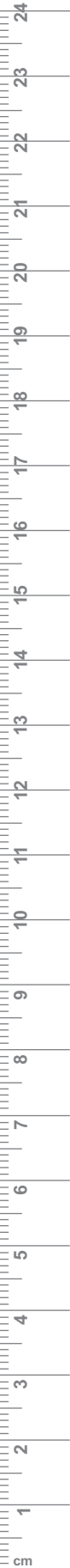

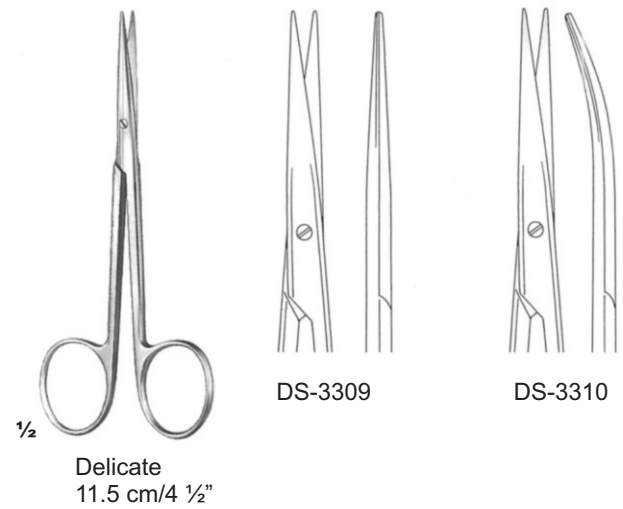
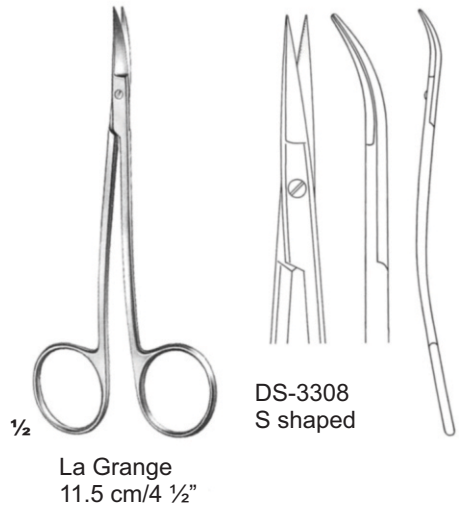

one toothed cutting edge

one toothed cutting edge

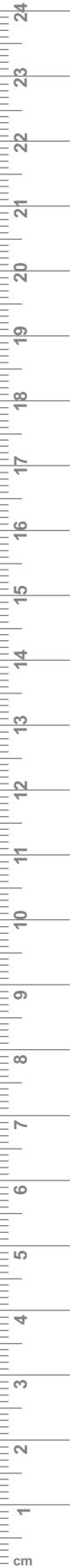
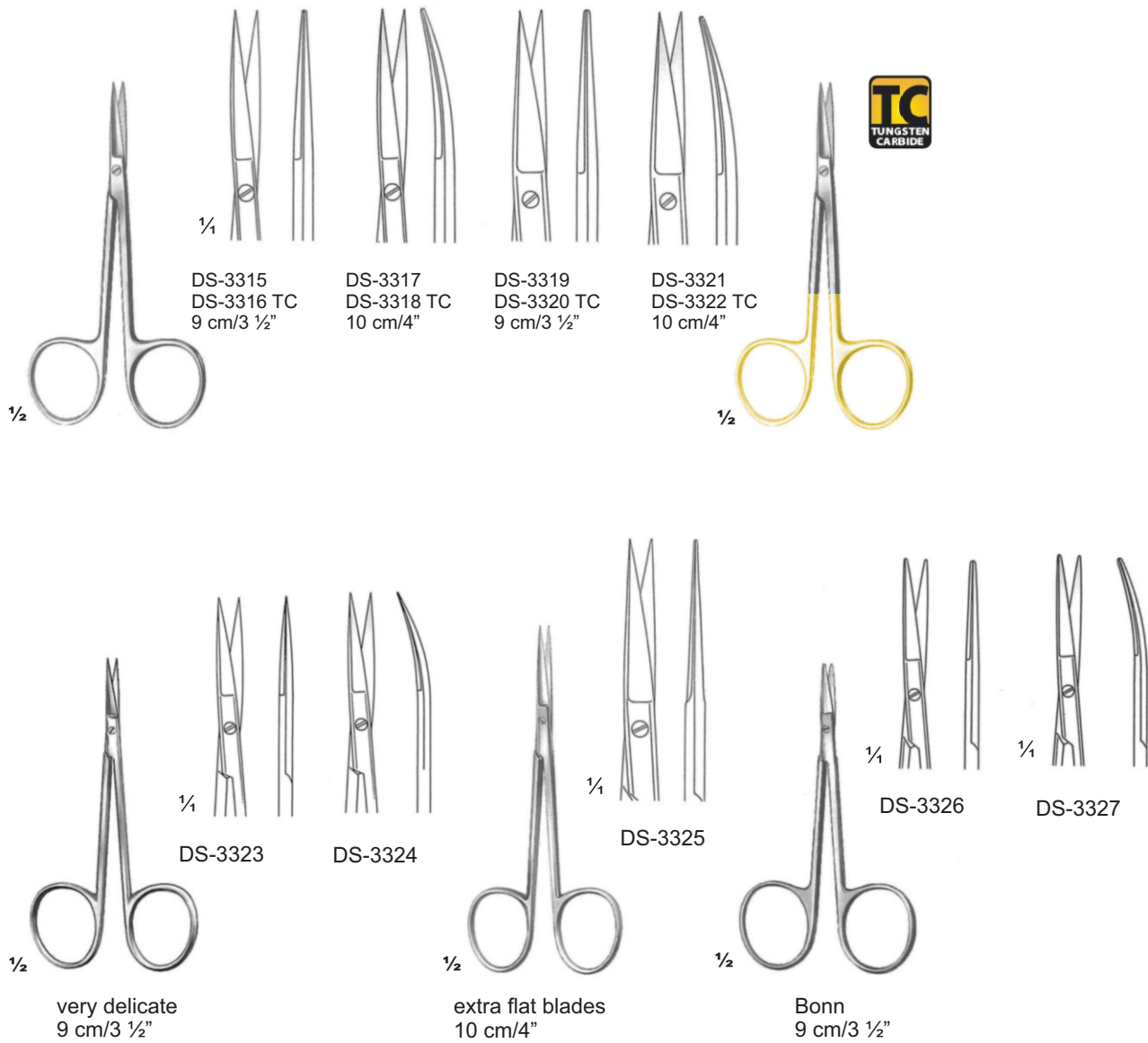

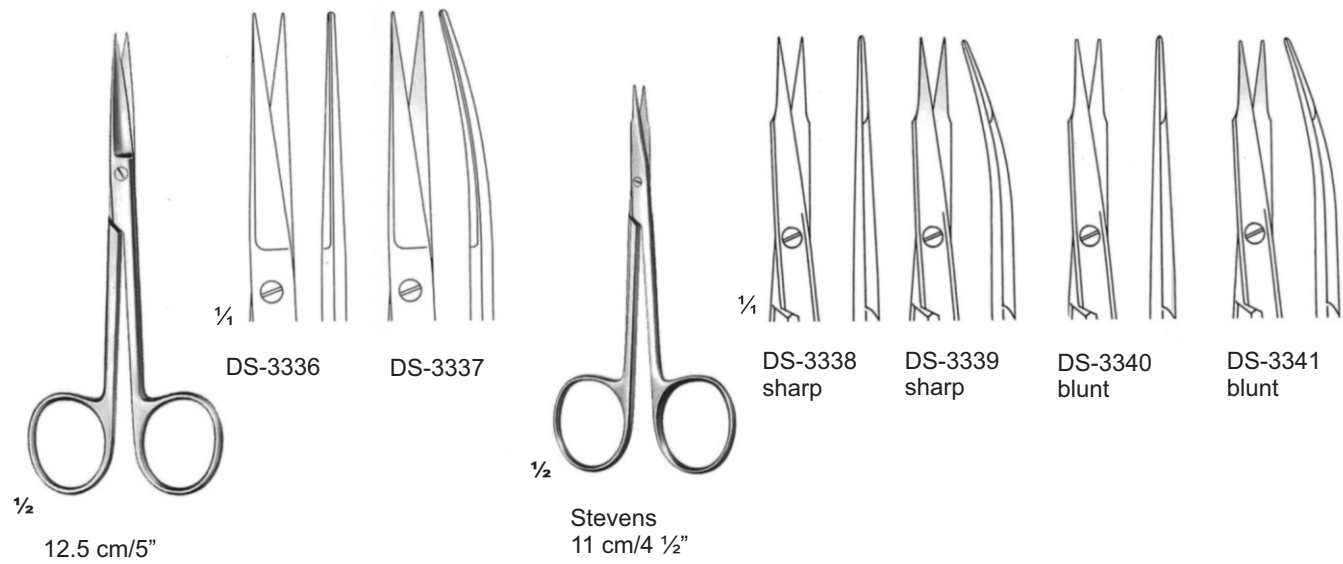
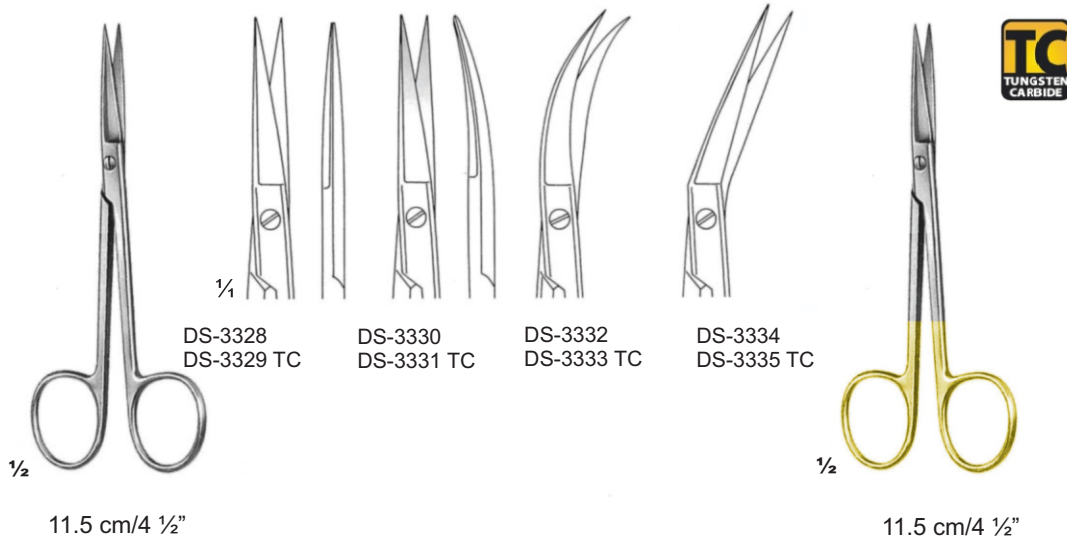

Stitch scissors ● EN
 Fadenscheren ● DE
 Tijeras para hilos ● ES

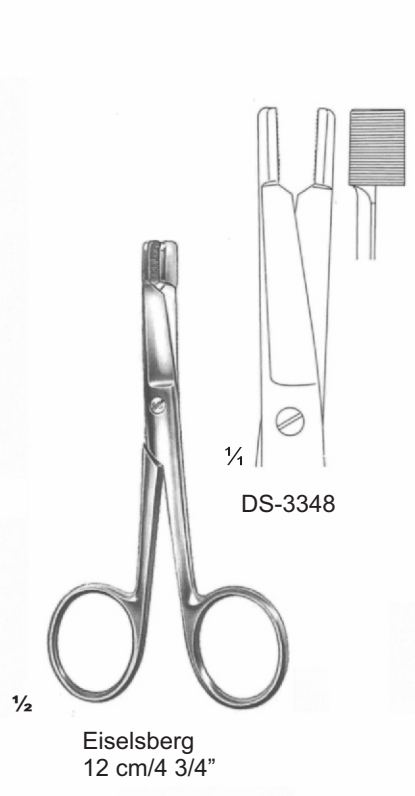
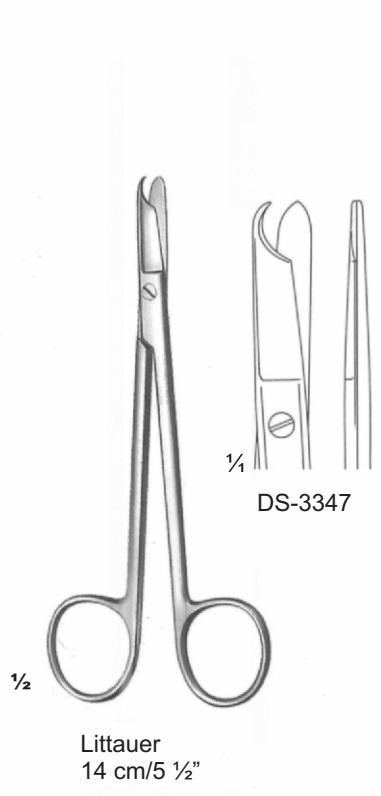
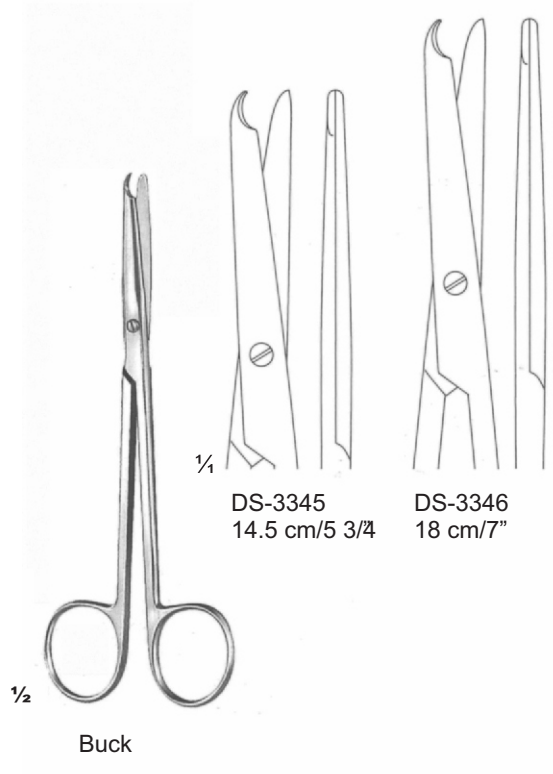
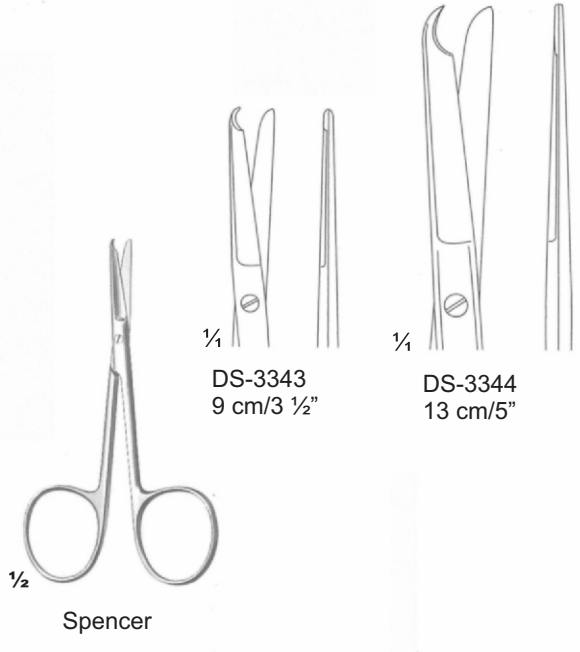
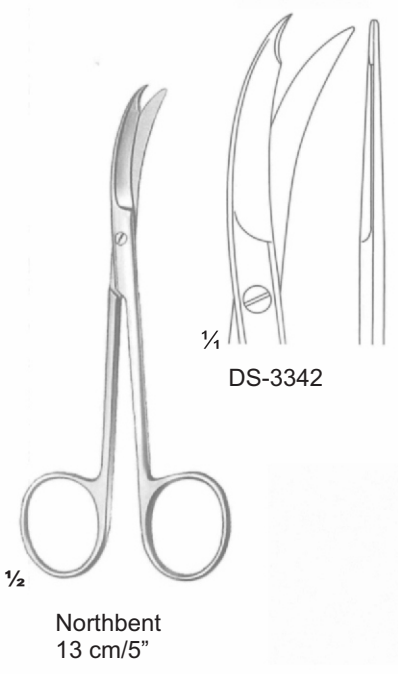
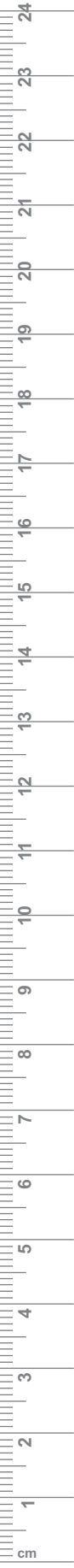

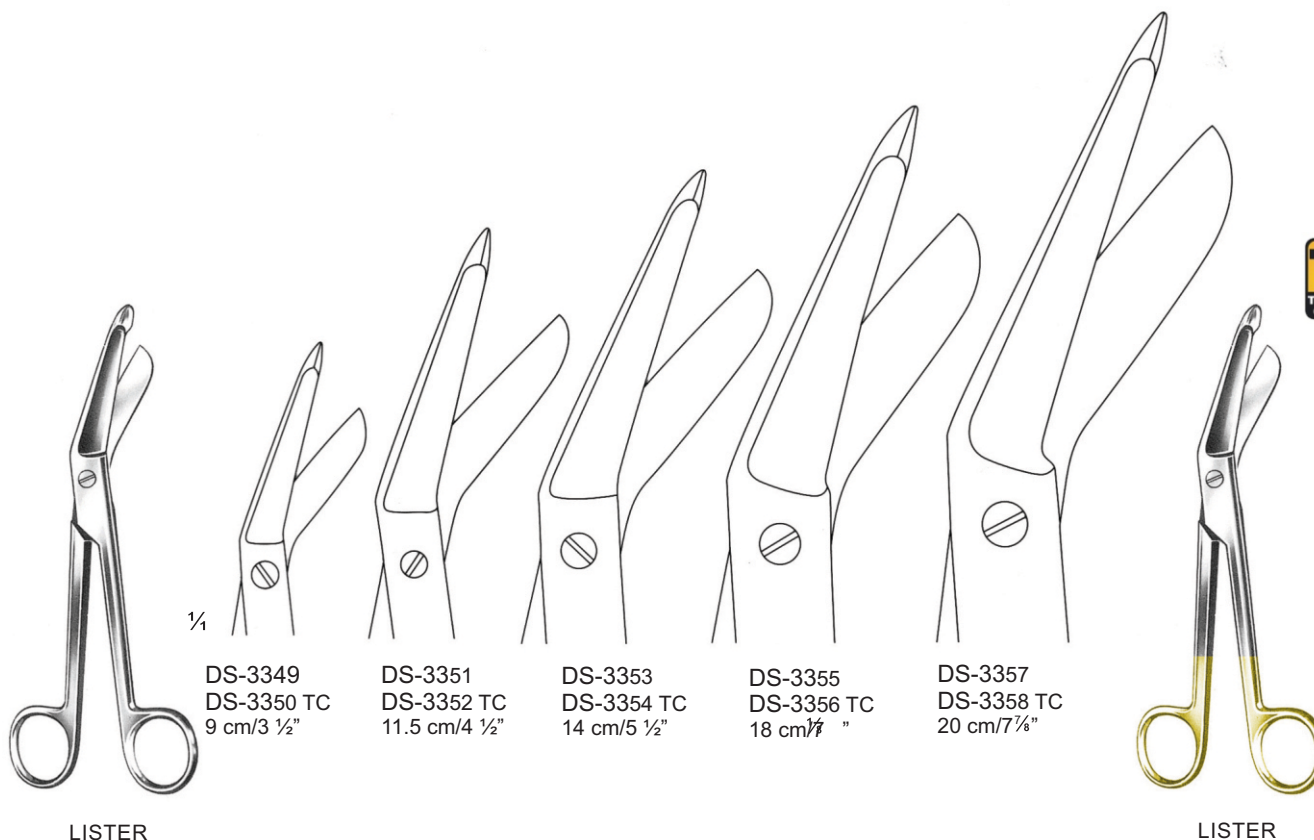

LISTER

LISTER

DS-3349
 DS-3350 TC
 9 cm/3 1/2"

DS-3351
 DS-3352 TC
 11.5 cm/4 1/2"

DS-3353
 DS-3354 TC
 14 cm/5 1/2"

DS-3355
 DS-3356 TC
 18 cm/7 "

DS-3357
 DS-3358 TC
 20 cm/7 1/8"

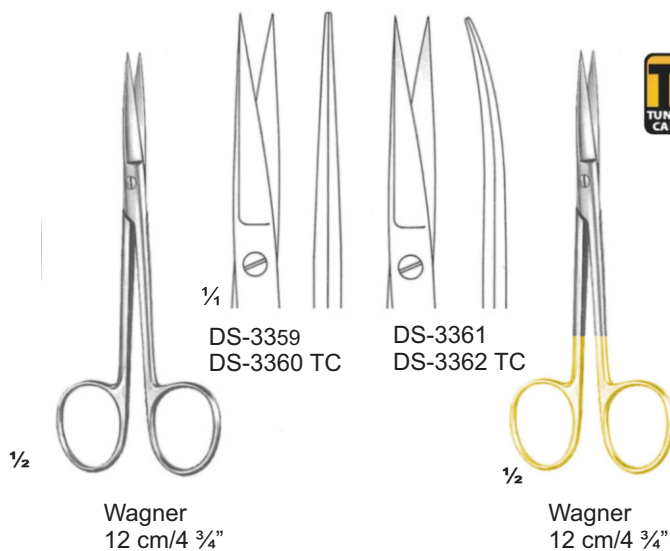

Wagner
 12 cm/4 3/4"

Wagner
 12 cm/4 3/4"

Delicate dissecting scissors ● EN
 Feine präparierscheren ● DE
 Tijeras finas de disección ● ES

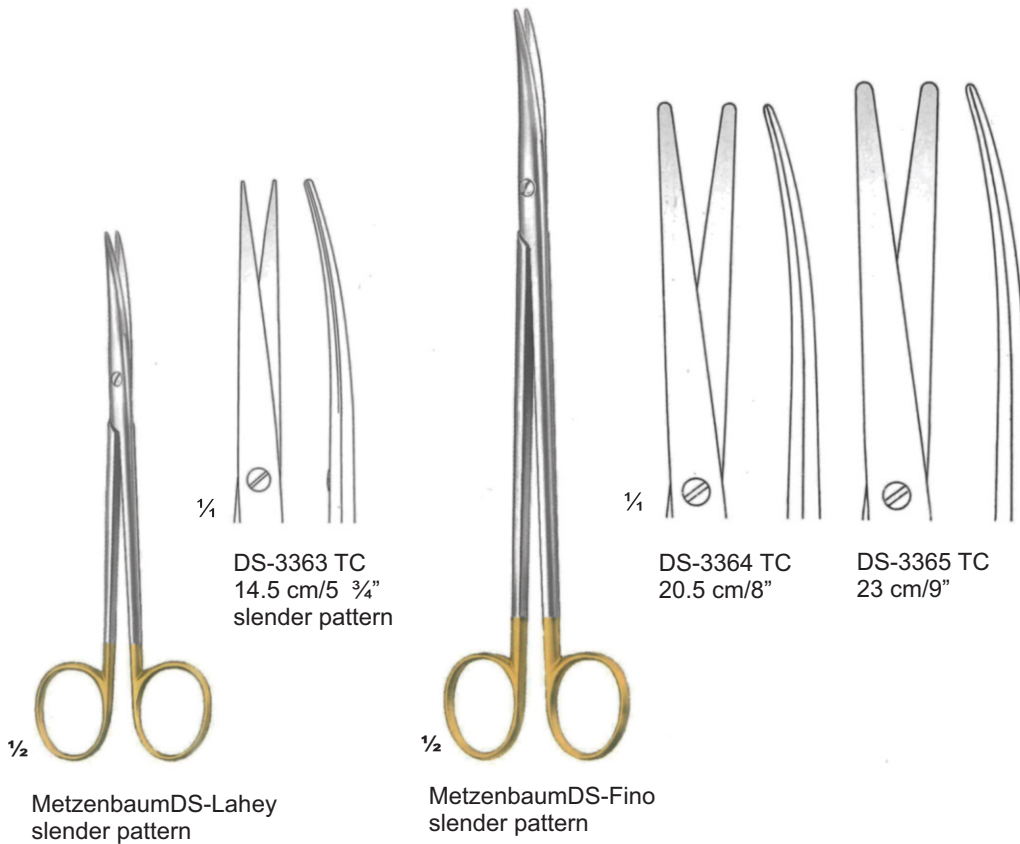

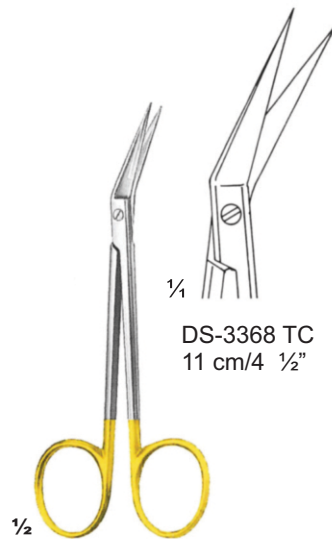
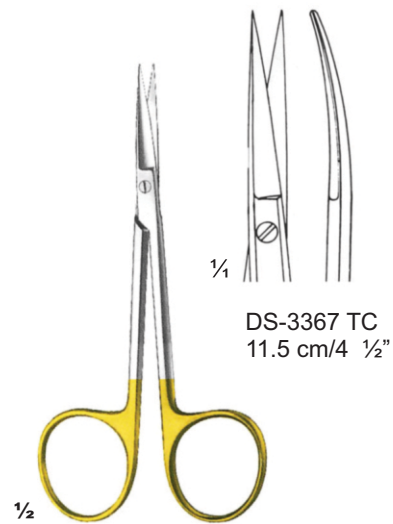
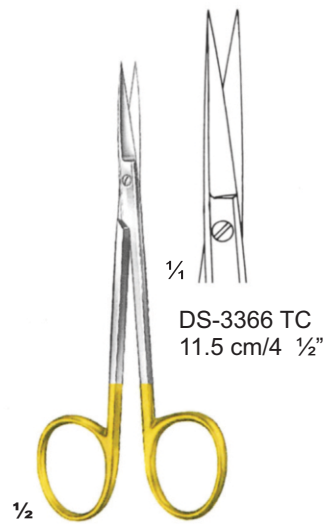

Ragnell

Gum scissors — EN
 Zahnfleschscheren — DE
 Tijeras para encías — ES

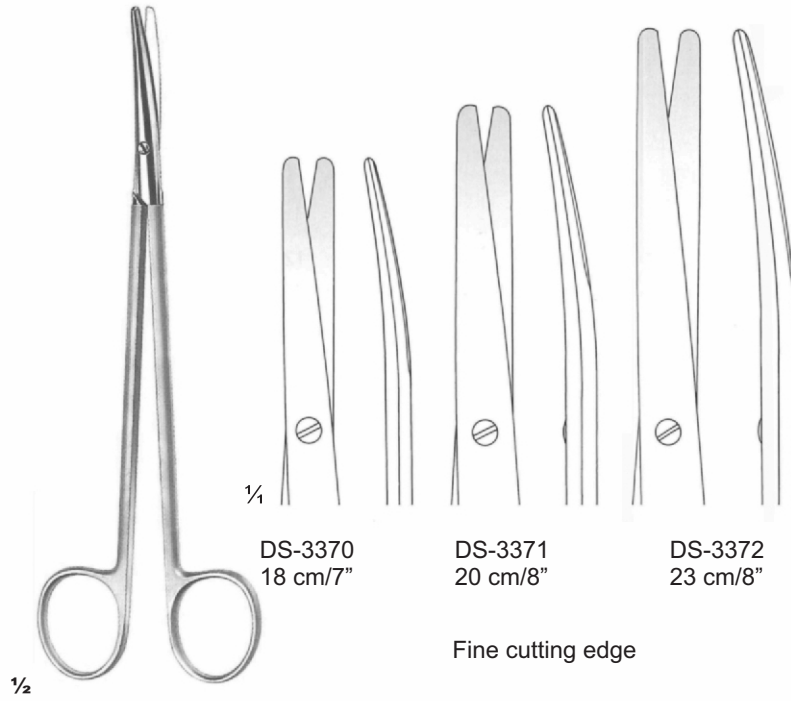

Metzenbaum

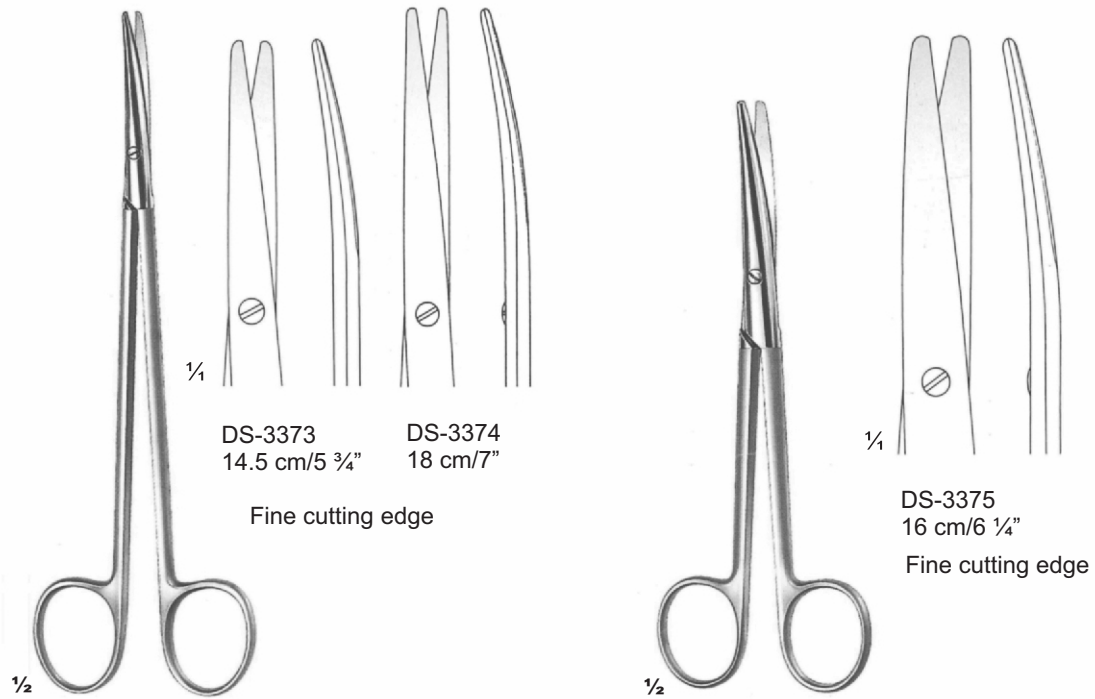

Metzenbaum

MayoDS-Lexer
Standard Pattern



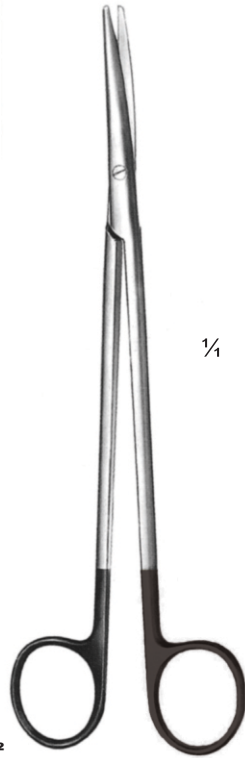

1/4



DS-3376 TCS
14.5 cm/5 3/4"



DS-3377 TCS
18 cm/7"

For synthetic suture material
One toothed cutting edge

1/2



1/4



DS-3378 TCS
14.5 cm/5 3/4"



DS-3379 TCS
17 cm/6 3/4"

For synthetic suture material
One toothed cutting edge

1/2



Denis
Surgical

72

- EN** Micro Scissors
- DE** Mikroschere
- ES** Micro tijeras

Page 172 to 173





- | | | |
|--------------|---------|---------|
| 15 cm/6" | DS-3401 | DS-3405 |
| 18 cm/7" | DS-3402 | DS-3406 |
| 21 cm/8 1/4" | DS-3403 | DS-3407 |
| 23 cm/9" | DS-3404 | DS-3408 |

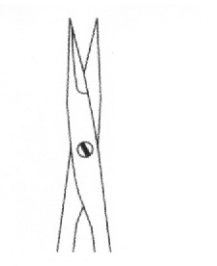
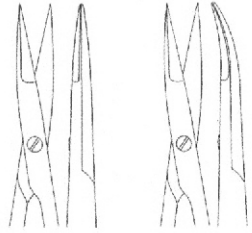

Streamlined



- | | | |
|--------------|---------|---------|
| 15 cm/6" | DS-3409 | DS-3413 |
| 18 cm/7" | DS-3410 | DS-3414 |
| 21 cm/8 1/4" | DS-3411 | DS-3415 |
| 23 cm/9" | DS-3412 | DS-3416 |

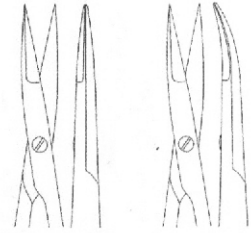

Streamlined

72

MICRO SCISSORS

Micro Scissors ● EN
Mikroscheren ● DE
MicroDS-ciseaux ● ES



NOYES
DS-3417
13 cm/5"





Denis
Surgical

73

- EN** Orthodontics
- DE** Kieferorthopädie
- ES** Ortodoncia

Page 174 to 190

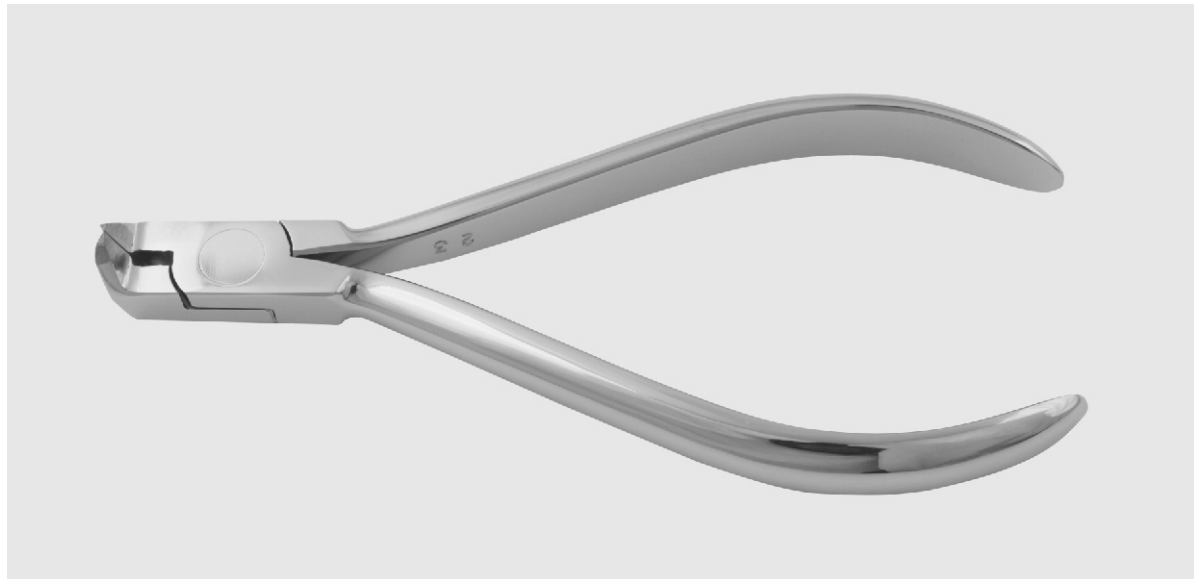



DS-3501
14 cm/5 1/2"



LANGENBECK
DS-3502
15 cm/6"



DS-3503
14 cm/5 1/2"



DS-3504
12,5 cm/4 3/4"



DS-3505
13 cm/5"



DS-3506
14 cm/5 1/2"

Flat nose pliers, Wire bending pliers ● EN
 RundDS-, Flachzange, Drahtbiegezange ● DE
 Pincas plates, rondes, Pince pour technique ● ES



GOSLEE
DS-3507
14 cm/5 1/2"



GOSLEE
DS-3508
14 cm/5 1/2"



GOSLEE
DS-3509
14 cm/5 1/2"



DS-3510
12,5 cm/4 3/4"



DS-3511
15 cm/6"



DS-3512
13 cm/5"





DS-3513
13 cm/5"



DS-3514
13 cm/5"



LANGENBECK
DS-3515
14 cm/5 1/2"



DUMONT
DS-3516
11,5 cm/4 1/2"



DUMONT
DS-3517
11,5 cm/4 1/2"



DUMONT
DS-3518
11,5 cm/4 1/2"

End and side nippers ● EN
 Zwickzangen ● DE
 CoupeDS-fi ● ES



Wire cutter, front action



DS-3519
11 cm/4 1/4"



DS-3520
11,5 cm/4 1/2"



DS-3521
12,5 cm/4 3/4"



DS-3522
11,5 cm/4 1/2"



DS-3523
11,5 cm/4 1/2"

0,7 mmØ
for hard wire up to

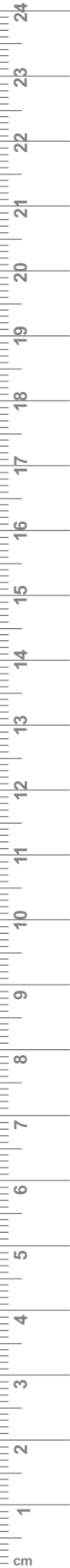



Denis
Surgical

- EN —• Wire Bending Pliers
- DE —• Drahtbiegezangen
- ES —• Alicates para doblar alambre

73

ORTHODONTICS



1,0 mm Ø
for hard wire up to



DS-3524
15 cm/6"



SCHWARZ
DS-3525
13 cm/5"
Modell I

SCHWARZ
DS-3528
14,5 cm/5 3/4"



SCHWARZ
DS-3526
13 cm/5"
Modell II

FISCHER
DS-3529
14 cm/5 1/2"





ANDRESEN
DS-3530
13,5 cm/5 1/2"



STADLER
DS-3533
15 cm/6"



sliding forming pliers

McKELLOPS
DS-3531
17 cm/6 3/4"

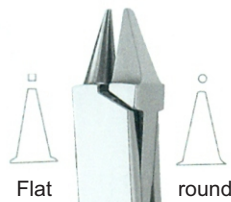

ANGLE
DS-3534
12,5 cm/5"



McKELLOPSDS-
STADLER
DS-3532
16 cm/6 1/4"



ANGLE
DS-3535
12,5 cm/5"





ADAMS
DS-3536
13 cm/5"



YOUNG
DS-3537
13 cm/5"



TWEED
DS-3538
13,5 cm/5 1/2"



TWEED
DS-3539
13,5 cm/5 1/2"



DE LA ROSA
DS-3540
12,5 cm/5"

Contouring pliers



DE LA ROSA
DS-3541
12,5 cm/5"



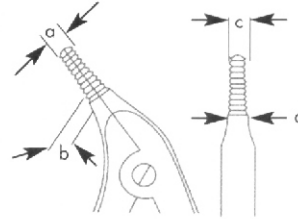

a	b	c	d
3,3	4	2,3	3,0
4,4	5	3,4	3,8

Telescope crown pliers



BOEHM
DS-3554
12 cm/4 3/4"



BOEHM
DS-3555
15 cm/4"





**OLIVER
JONES
DS-3556
15 cm/6"**



**OLIVER
DS-3557
15 cm/6"**



**OLIVER
DS-3558
15 cm/6"**

Step loop bending pliers



**ADERER
DS-3559
13,5 cm/5 1/4"**



**NANCE
DS-3560
12,5 cm/5"**

Ligature pliers, Ligature cutter ● EN
 Ligaturzangen, LigaturDS-Schneider ● DE
 Pincas à ligature, ligature coupantes ● ES



0,7 mm Ø

for hard wire up to



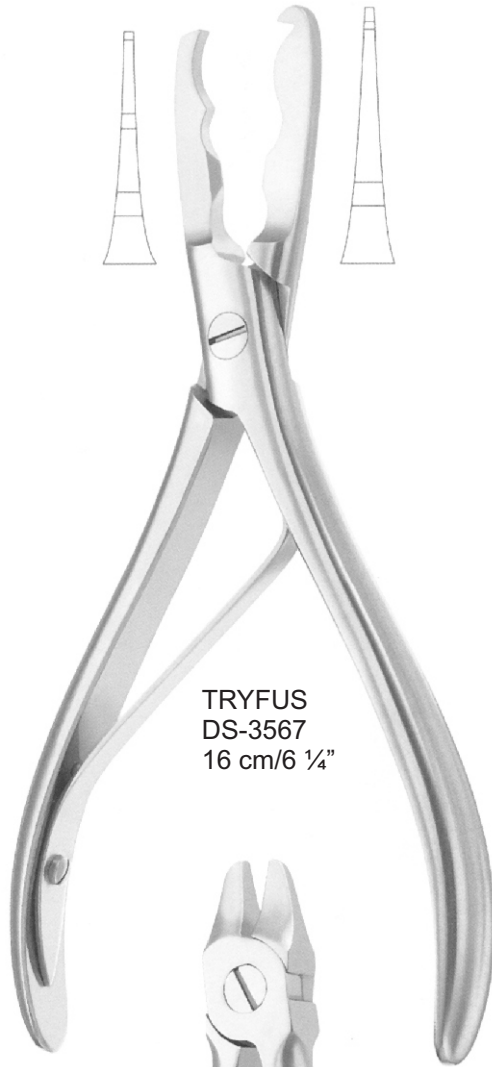

TRYFUS
DS-3567
16 cm/6 1/4"

Crown stretching pliers



PEESO
DS-3568
12 cm/6 1/4"

smooth



HOW
DS-3571
14 cm/5 1/2"

straight



PEESO
DS-3569
13,5 cm/5 1/4"

serrated



HOW
DS-3572
14 cm/5 1/2"

curved



DS-3573
18 cm/7"



DS-3574
14,5 cm/5 3/4"

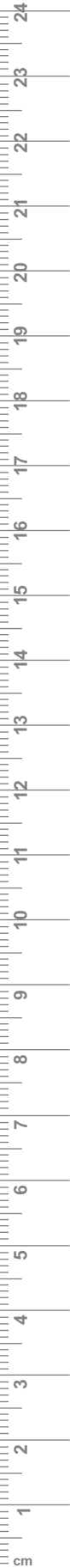



FREVERT
DS-3575
12 cm/4 3/4"



TRIPLEX
DS-3576
14 cm/5 1/2"



REYNOLD
DS-3577
12 cm/4 3/4"



GORDON
DS-3578
13,5 cm/5 1/4"

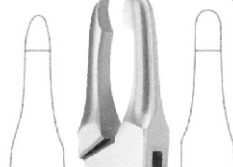

JOHNSON
DS-3579
13 cm/5"

Clamping tweezer / bracket holder



DS-3580 DS-3581 DS-3582 DS-3583 DS-3584 DS-3585 DS-3586 DS-3587
 Bracket P. Gauge DS-3588 DS-3589
 Band Remover Band Remover

Bracket positioning gauge



DS-3590





DS-3591
12.5 cm/5"



DS-3592
12.5 cm/5"



DS-3593
12.5 cm/5"



DS-3594
12.5 cm/5"



DS-3595
12.5 cm/5"



DS-3596
12.5 cm/5"



DS-3597
12.5 cm/5"



DS-3598
12.5 cm/5"



DS-3599
12.5 cm/5"



DS-3600
12.5 cm/5"



DS-3601
12.5 cm/5"

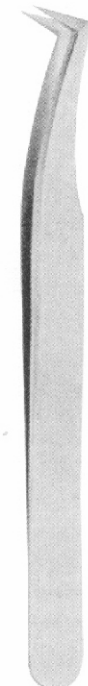

DS-3602
12.5 cm/5"



Denis
Surgical

74

- EN** Bone Rongeurs
- DE** Knochen Rongeure
- ES** Rongeurs de hueso



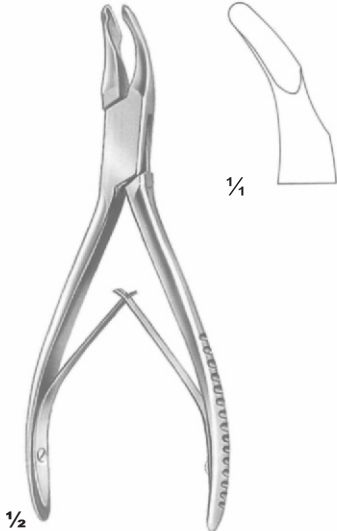

Cleveland
DS-3701
15 cm

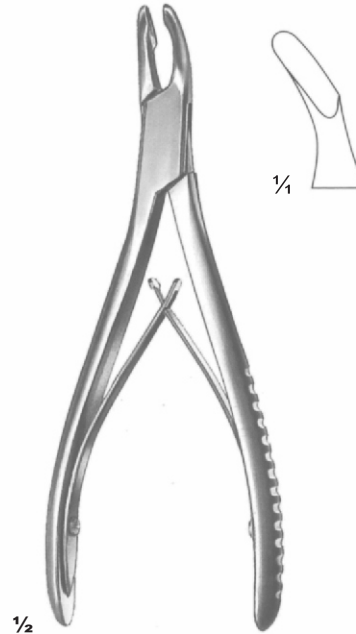

Cleveland
DS-3702
15 cm

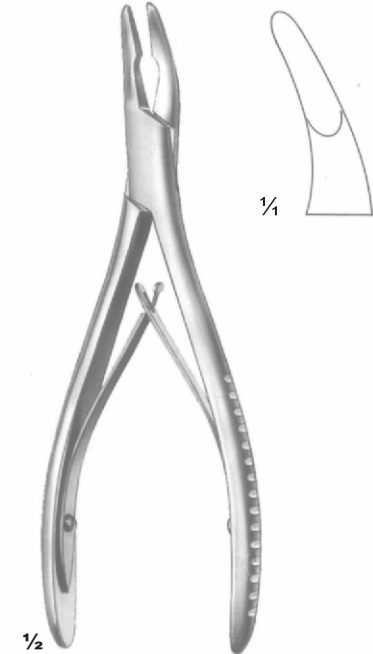

Hartmann
DS-3703
18 cm

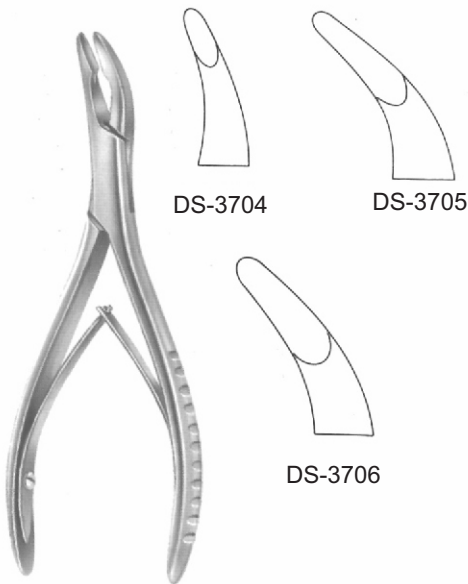

LUER
15 cm

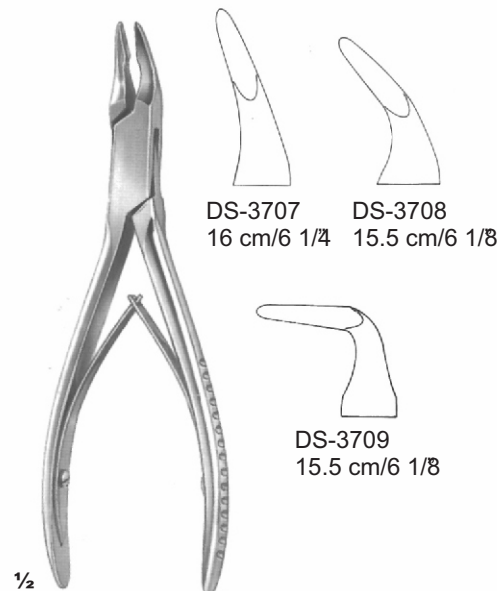

BLUMENTHAL
15 cm

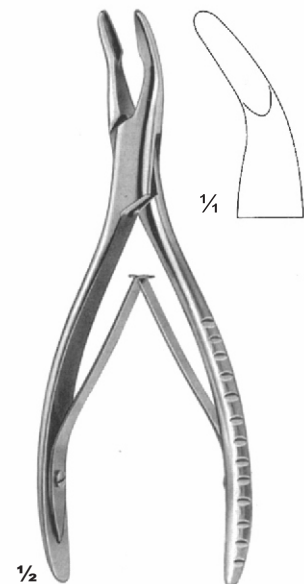

MEAD
DS-3710
16.5 cm/6 1/2"

Bone Rongeurs ● EN
 Knochennagetierte ● DE
 Roedores de hueso ● ES

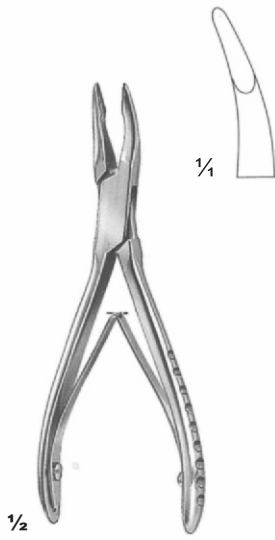

Friedmann
DS-3711
14 cm

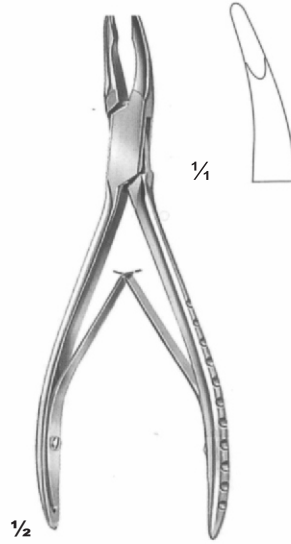

Friedmann
DS-3712
14 cm

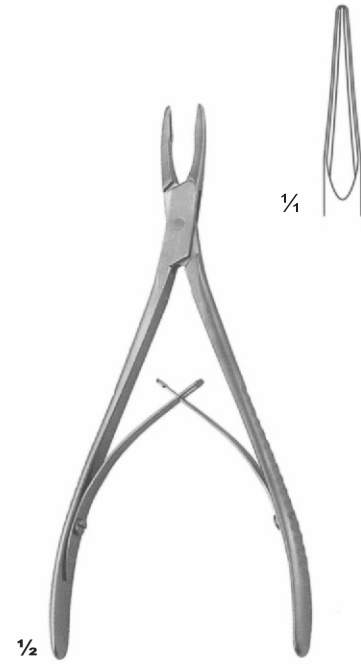

Friedmann DS-Micro
DS-3713
15 cm/6"
straight

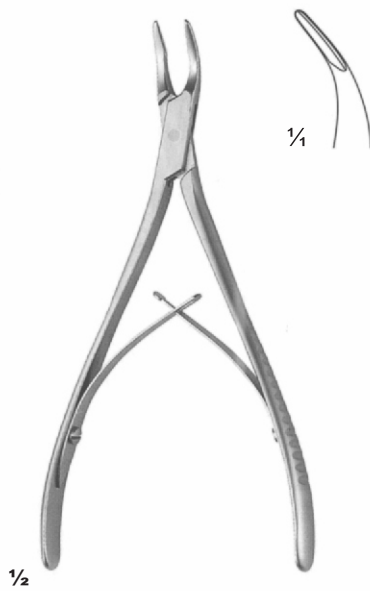

Friedmann DS-Micro
DS-3714
15 cm/6"
30°

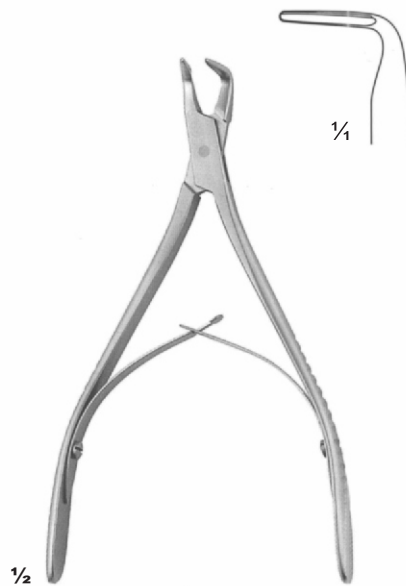

Friedmann DS-Micro
DS-3715
14.5 cm/5 3/4"
90°

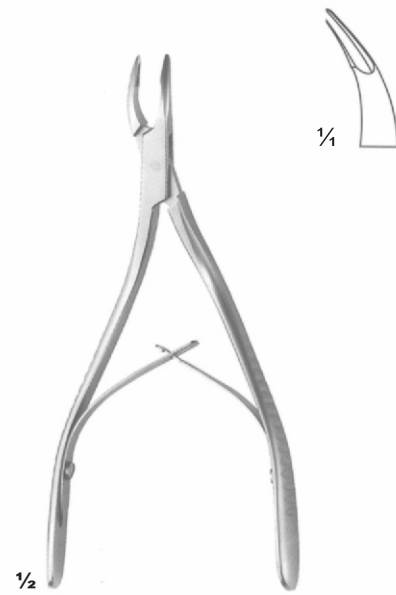

Friedmann DS-Micro
DS-3716
14.5 cm/5 3/4"
S shape
30°

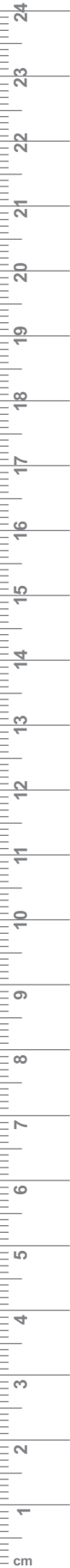

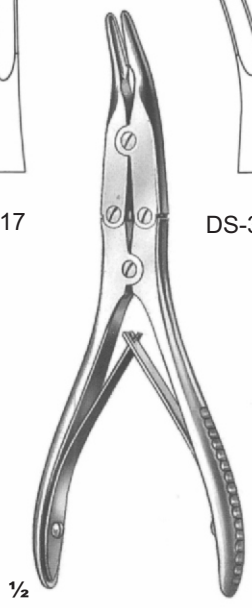

Bohler
15.5 cm/6"

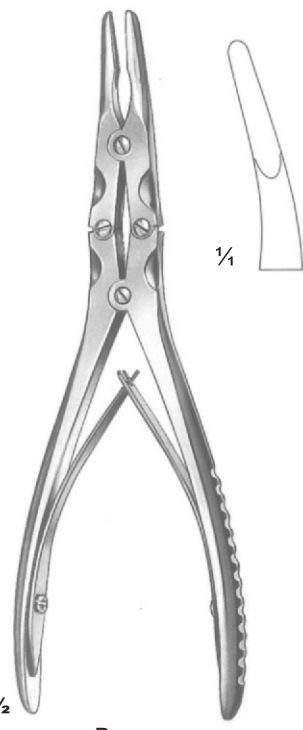

Beyer
DS-3719
18 cm/7"

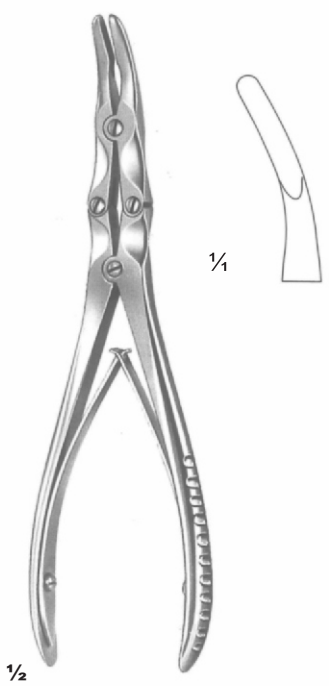

Mayfield
DS-3720
18 cm/7"

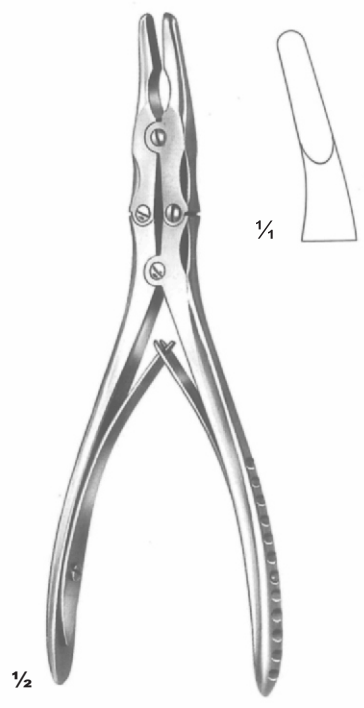

ZaufalDS-Jansen
DS-3721
18 cm/7"

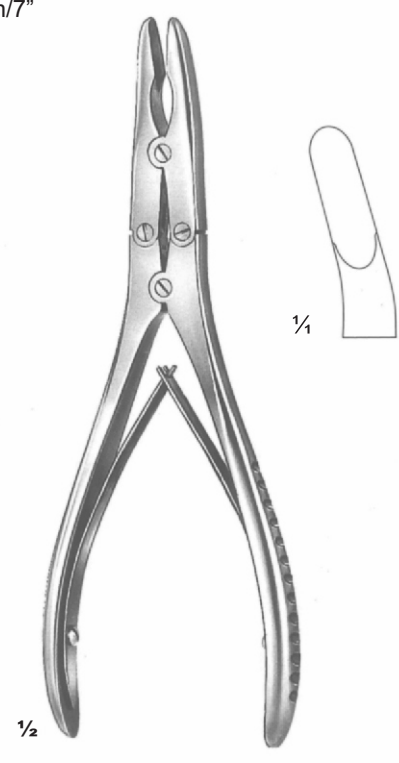

Ruskin
DS-3722
19 cm/7 1/2"



Denis
Surgical

75

EN

Forceps

DE

Zange

ES

Fórceps

Page 194 to 201





standard pattern



DS-3801
13 cm/5 1/8"



1/4

DS-3802
14.5 cm/5 3/4"



DS-3803
16 cm/5 1/4"



DS-3804
18 cm/7"



1/4

DS-3805
20 cm/7 7/8"



slender pattern



DS-3806
13 cm/5 1/8"



1/4

DS-3807
14.5 cm/5 3/4"



DS-3808
16 cm/5 1/4"



DS-3809
18 cm/7"

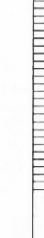



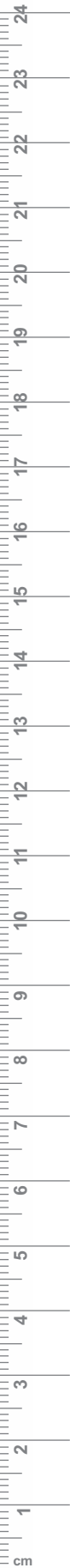
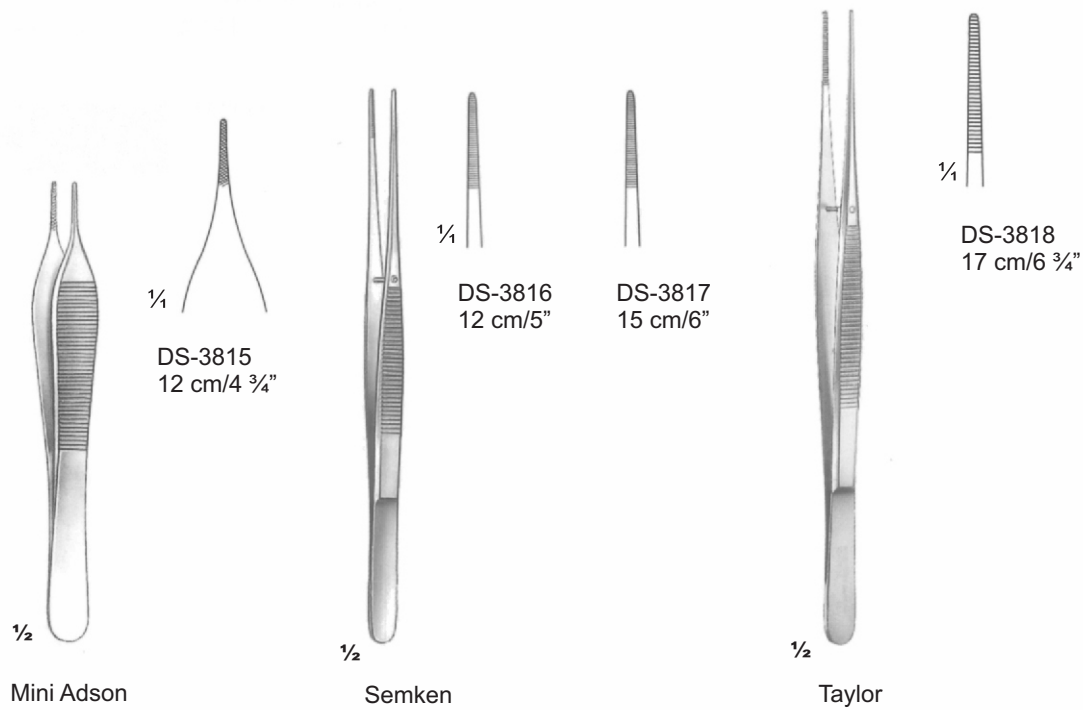
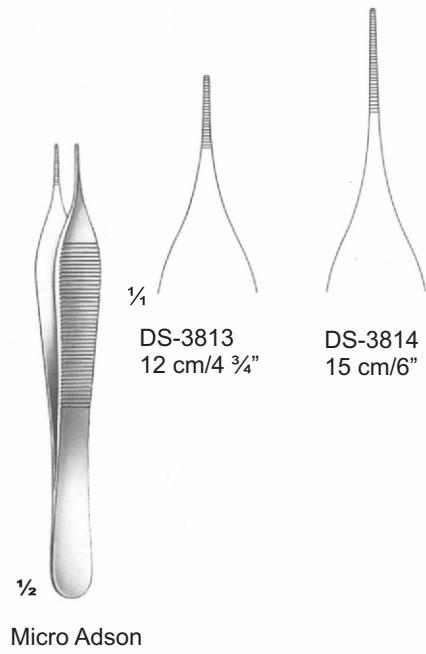
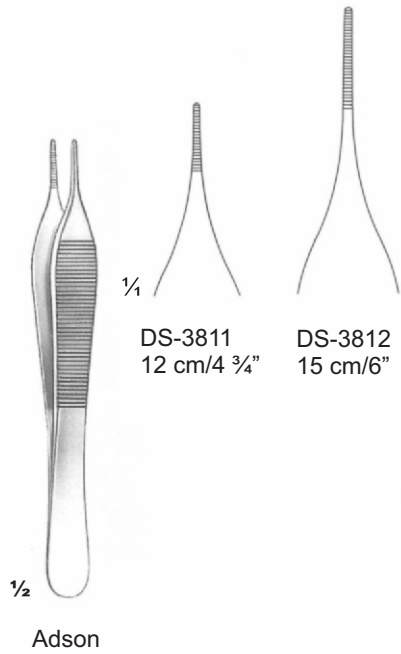

1/4

DS-3810
20 cm/7 7/8"

Dressing Forceps — EN
 Verbandzange — DE
 Vendaje de fórceps — ES









				
	1/4			1/4
DS-3819 13 cm/5 1/8" 1x2	DS-3820 14.5 cm/5 3/4" 1x2	DS-3821 16 cm/6 1/4" 1x2	DS-3822 18 cm/7" 1x2	DS-3823 20.5 cm/8 1/8" 1x2



Standard Pattern



				
1/4	1/4			1/4
DS-3824 13 cm/5 1/8" 1x2	DS-3825 14.5 cm/5 3/4" 1x2	DS-3826 16 cm/6 1/4" 1x2	DS-3827 18 cm/7" 1x2	DS-3828 20.5 cm/8 1/8" 1x2



Slender Pattern



	
1/4	1/4
DS-3829 12 cm/4 3/4" 1x2	DS-3830 15 cm/5 1/8" 1x2

Adson



	
1/4	1/4
DS-3831 12 cm/4 3/4" 1x2	DS-3832 12 cm/4 3/4" 1x2

Mini Adson

Dressing Forceps ● EN
 Verbandzange ● DE
 Vendaje de fórceps ● ES

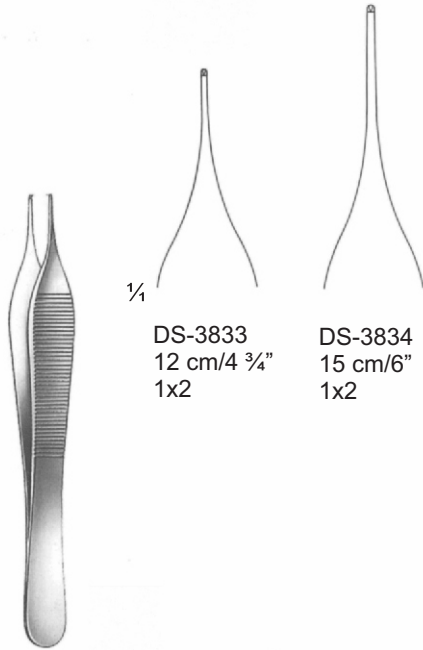

1/4
 DS-3833
 12 cm/4 3/4"
 1x2

DS-3834
 15 cm/6"
 1x2

Mikro Adson

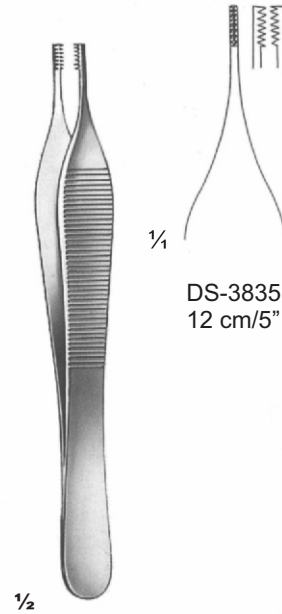

1/4
 DS-3835
 12 cm/5"

1/2

AdsonDS-Brown



1/4
 DS-3836
 12.5 cm/5"
 1x2

DS-3837
 15 cm/6"
 1x2

Semken

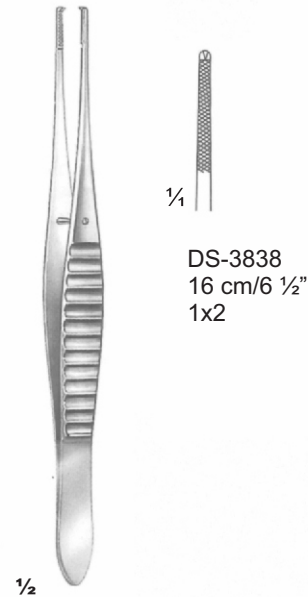

1/4
 DS-3838
 16 cm/6 1/2"
 1x2

1/2

Gillies



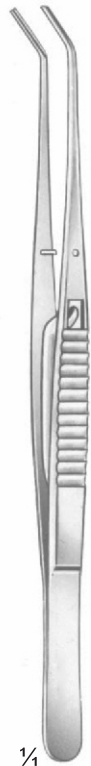

1/4
DS-3838A
15 cm/6"

suited to hold silver pins, nerveDS-broaches
and for introducing medicines



1/2

D = 1,6 mm



1/4
DS-3839
16 cm/6 1/4"

D = 2,2 mm



1/4
DS-3840
16 cm/6 1/4"

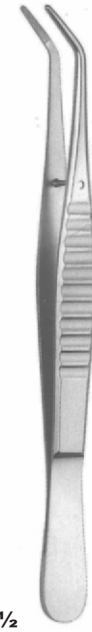

1/2



1/4
DS-3841
16 cm/6 1/4"

Suture and membrane forceps



1/2
LondonDS-College
15 cm/6"



1/4
DS-3842
No. 1

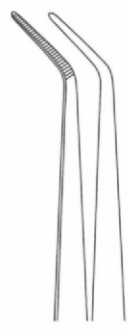

DS-3843
No. 3



DS-3844
No. 5



1/2
LondonDS-College
with lock
15 cm/6"



1/4
DS-3845
No. 1



DS-3846
No. 3



DS-3847
No. 5

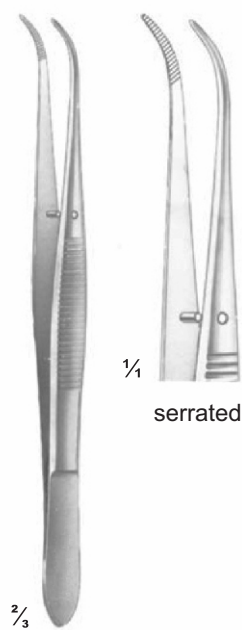

$\frac{2}{3}$
 Perry
 DS-3848
 13 cm/5"

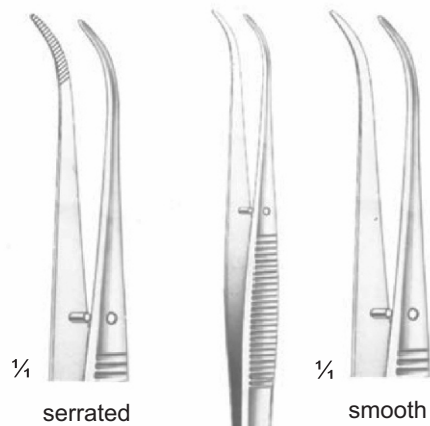

$\frac{2}{3}$
 Perry
 DS-3849
 13 cm/5"

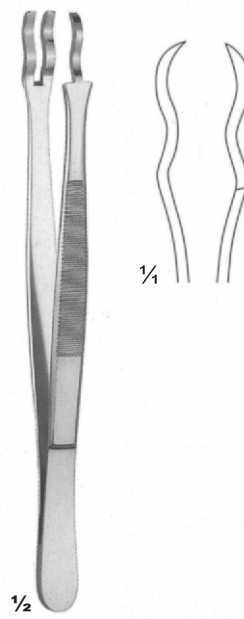

$\frac{1}{2}$
 DS-3850
 14.5 cm/5 $\frac{3}{4}$ "
 Frigz
 Grasping and
 sterilizing forceps

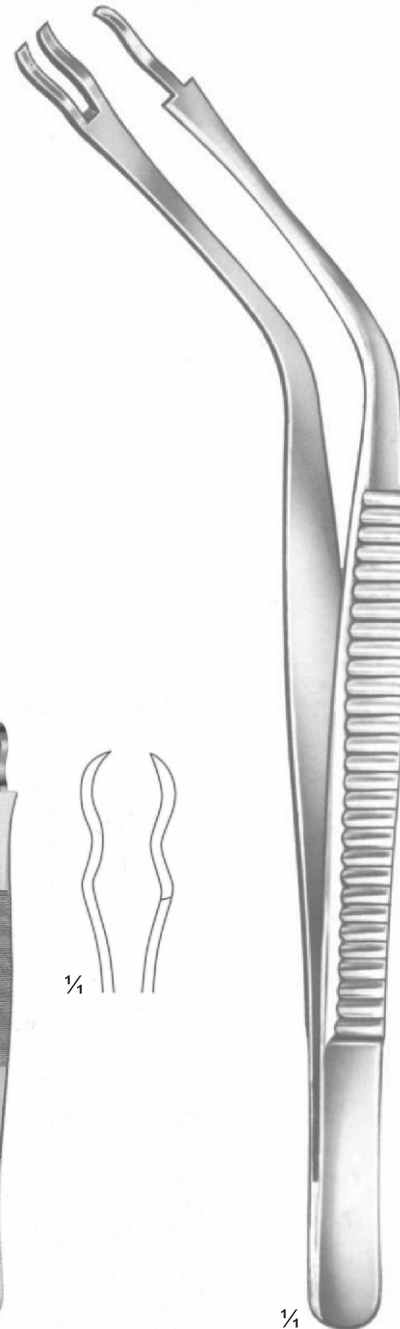

$\frac{1}{4}$
 DS-3851
 20 cm/8"
 Seizing and
 Sterilizing Forceps

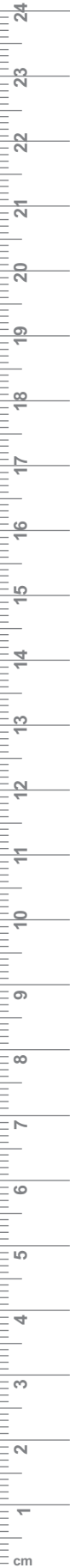



DeBakey
12 cm/5"



DS-3852
2,7 mm



DS-3853
1,5 mm



DS-3854
2,0 mm



DS-3855
2,0 mm



DS-3856
3,5 mm



CraneDS-Kaplan
Pocket marking forceps
15 cm/6"

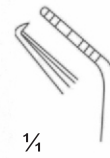

DS-3857
No. 1

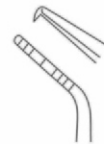

DS-3858
No. 2



Meriam
16 cm/6 1/4"

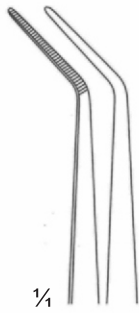

DS-3859
No. 1



DS-3860
No. 3



DS-3861
No. 5



Flagg
16 cm/6 1/4"



DS-3862
No. 1



DS-3863
No. 2



DS-3864
No. 3



DS-3865
No. 4

Dressing Forceps — EN
 Verbandzange — DE
 Vendaje de fórceps — ES



Standard

DS-3866 TC
14.5 cm/5 3/4"

DS-3867 TC
18 cm/ 7"

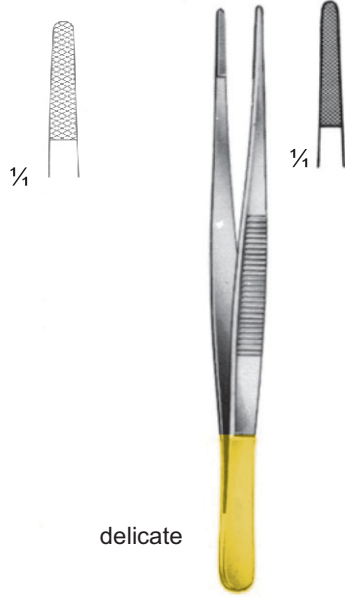

delicate

DS-3868 TC
14.5 cm/5 3/4"

DS-3869 TC
18 cm/7"



1/2

Adson



DS-3870 TC
12 cm/4 3/4
1x2



DS-3871 TC
15 cm/6"
1x2

mini profile



1/2

Gillies
DS-3872 TC
15.5 cm/6"
1x2



1/4
mini profile



1/2

DeBakey
DS-3873 TC
16 cm/6 1/4"

ATRAUMA



1/4
micro profile





Denis
Surgical

76

- EN** Scalpel Handles
- DE** Skalpellgriffe
- ES** Manchas de bistouris

Page 202 to 203

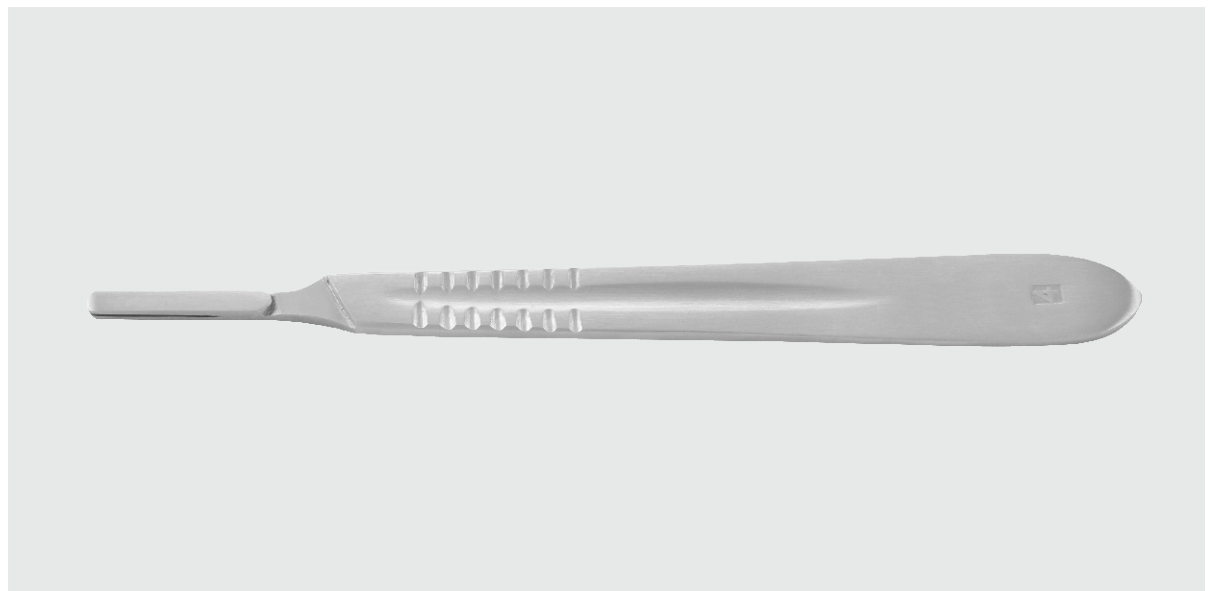

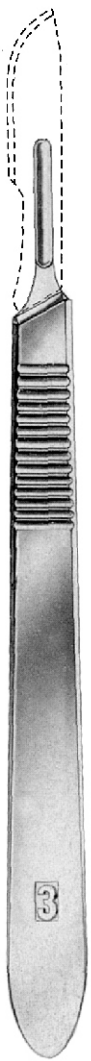

Standard
DS-3901
3

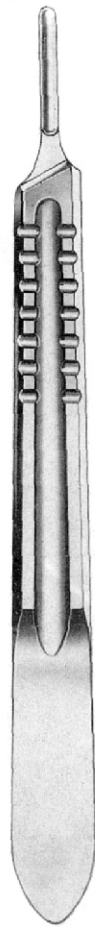

DS-3902
3



DS-3903
3
with scale

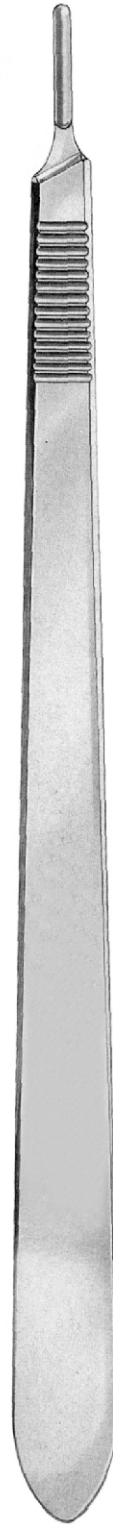

DS-3904DS-3L # 3L
DS-3905DS-3XL # 3XL

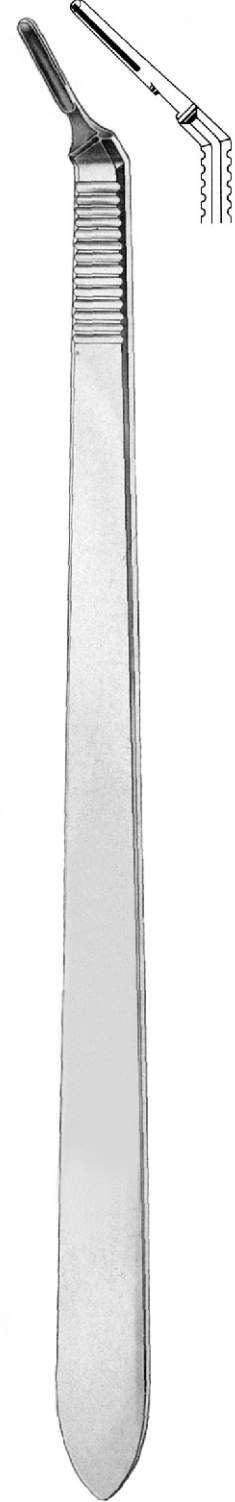

DS-3906DS-3L # 3L
DS-3907DS-3XL # 3XL
angled

Scalpel Handles — EN
 SkalpellDS-Griffe — DE
 Mangos de bisturios — ES

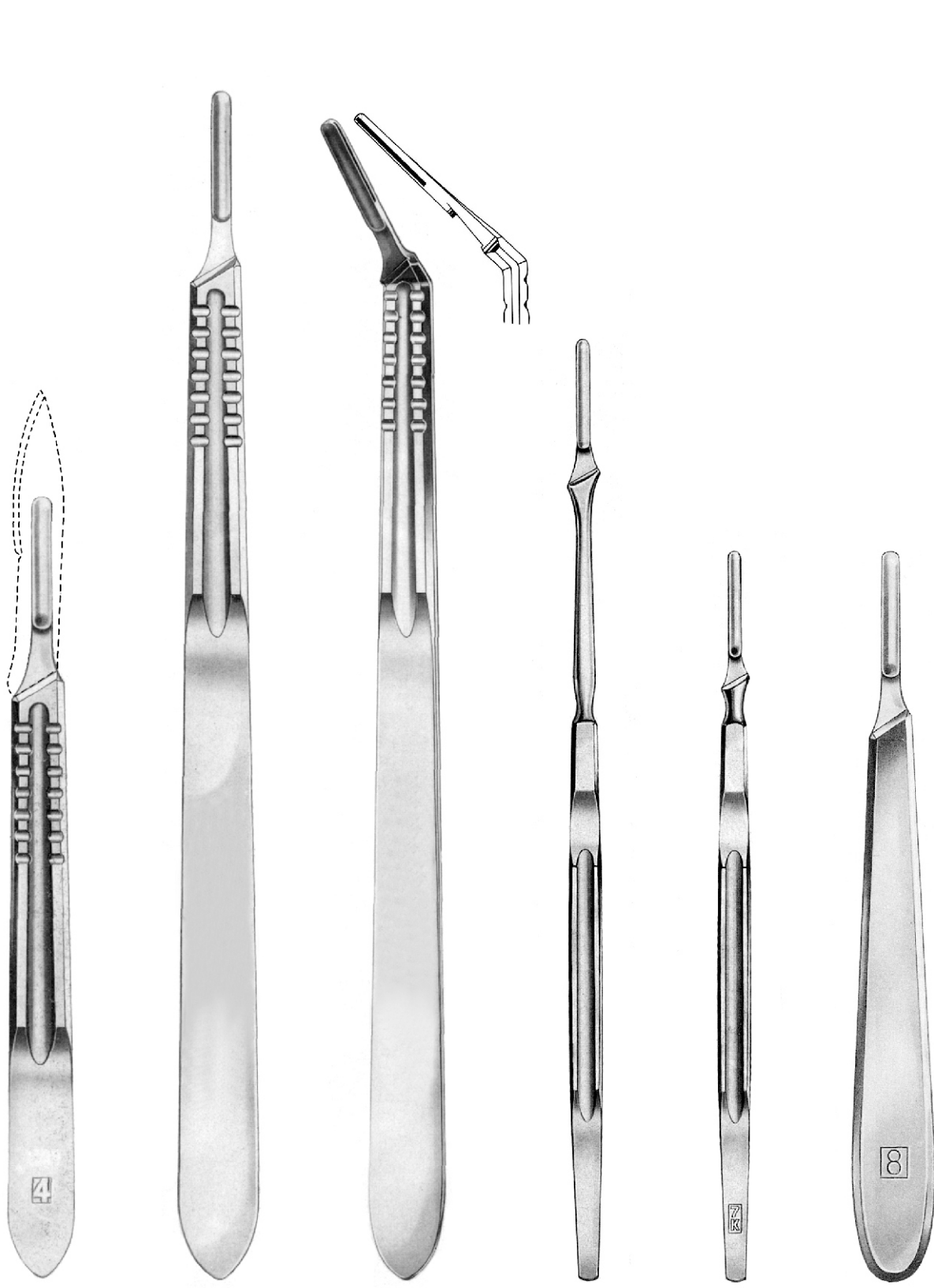

Standard
 DS-3908
 # 4

DS-3909DS-4L # 4L
 DS-3910DS-4XL # 4XL

DS-3911DS-4L # 4L
 DS-3912DS-4XL # 4XL
 angled

DS-3913
 # 7

DS-3914
 # 7K

Collin
 DS-3915
 Fig. 8



Denis
Surgical

77

- EN** Mallets
- DE** Schlägel
- ES** Mazos

Page 204 to 206

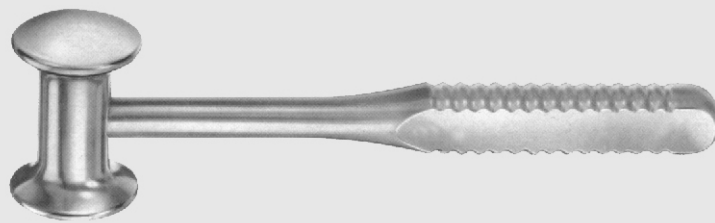

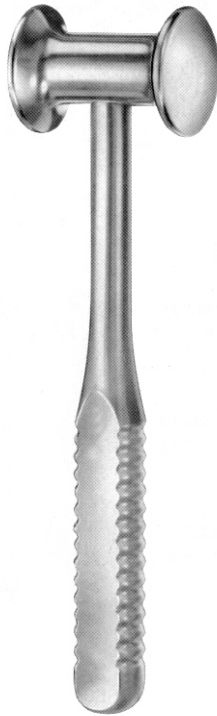

BERGMANN
DS-3951
24 cm/9 1/2"
300 grams



WILLIGER
24 cm/9 1/2"
lead filled

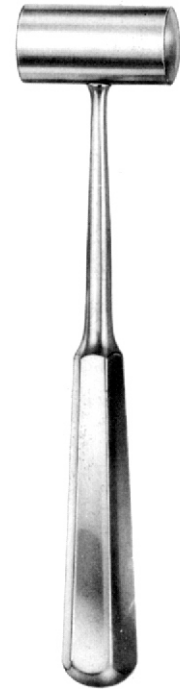
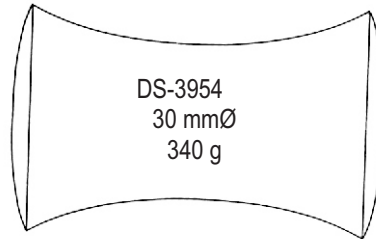
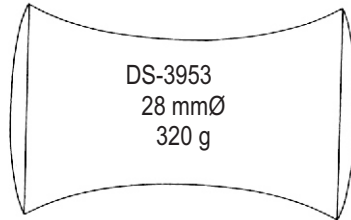
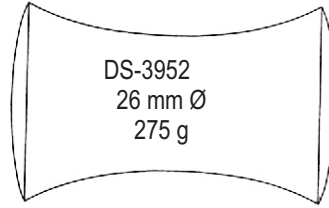

Ø 27 mm
300 g

PARTSCH
DS-3955
18 cm/7 1/8"
with hollow handle



DOYEN
21 cm/8 1/4"

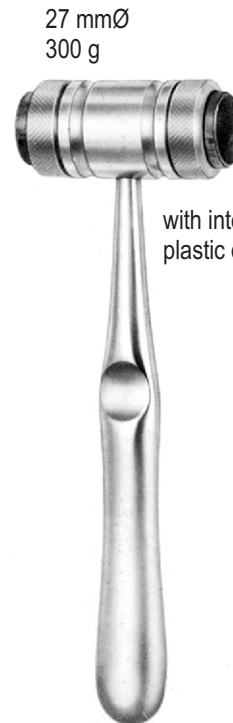
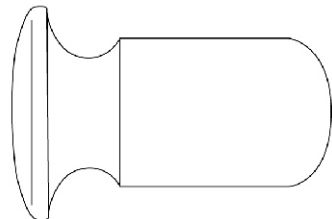
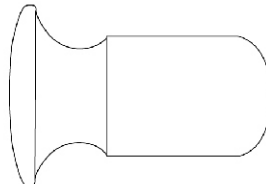
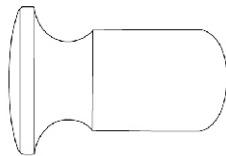

27 mm Ø
300 g

with interchangeable
plastic disks

MEAD
DS-3959 19 cm/7 1/2"
DS-3960 pair of spare disks

Mallets — EN
 Hämmer — DE
 Martillos — ES



HAJEK
 DS-3961
 20 cm/7⁷/₈"
 200 g
 Ø 27 mm



KIRK
 DS-3962
 21 cm/8¹/₄"
 650 g
 Ø 38 mm

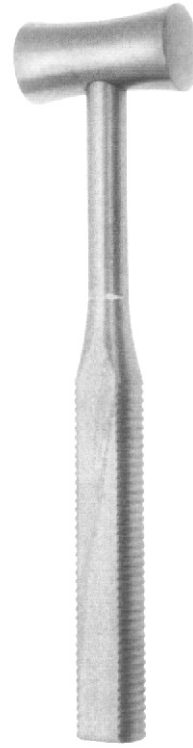

BERGMANN
 DS-3963
 24.5 cm/9⁵/₈"
 400 g
 Ø 30 mm

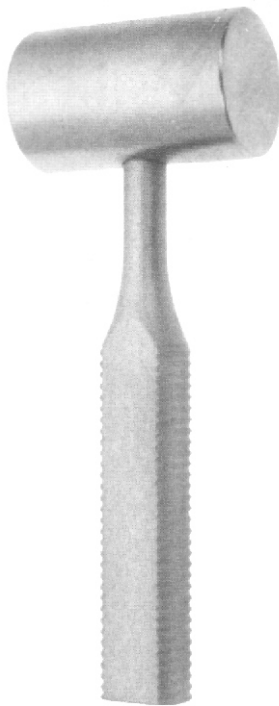

HEATH
 DS-3964
 18.5 cm/7¹/₄"
 700 g
 Ø 40 mm



with interchangeable
 disks
 DS-3966

DS-3965
 18.5 cm/7¹/₄"
 240 g
 Ø 25 mm

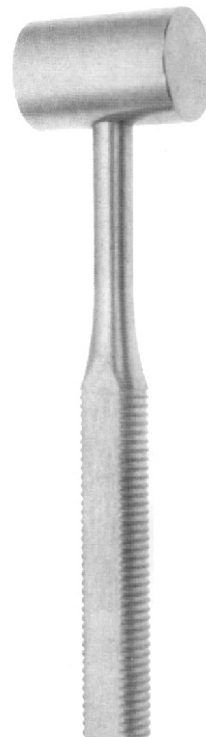

OMBREDANNE
 DS-3967
 24 cm/9¹/₂"
 700 g
 Ø 40 mm





DS-3968
26.5 cm/10 3/8"
Ø 50 mm
1300 g

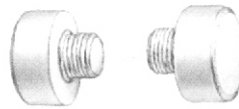

DS-3969
spare facings (pair)

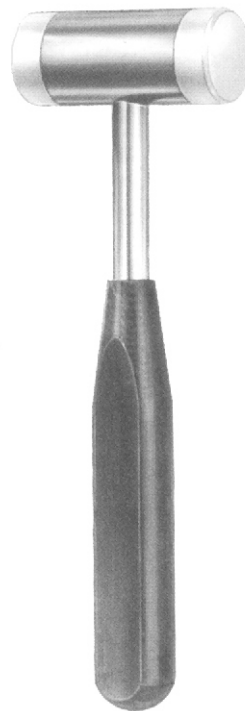

DS-3970
19 cm/7 1/2"
Ø 25 mm
300 g



HERBERT
DS-3971
19 cm/7 1/2"
Ø 25 mm
215 g



Denis
Surgical

78

- EN** Cassettes
- DE** Kassetten
- ES** Cassettes

Page 207 to 210





Elongated Holes

Dimension(mm)

DS-4001	05DS-Instruments	78 x 182 x 32
DS-4002	10DS-Instruments	142 x 182 x 32
DS-4003	20DS-Instruments	270 x 182 x 32



Round Bottom with Strip Lock

Dimension(mm)

DS-4004	05DS-Instruments	90 x 182 x 25
DS-4005	10DS-Instruments	145 x 182 x 25
DS-4006	20DS-Instruments	270 x 182 x 25

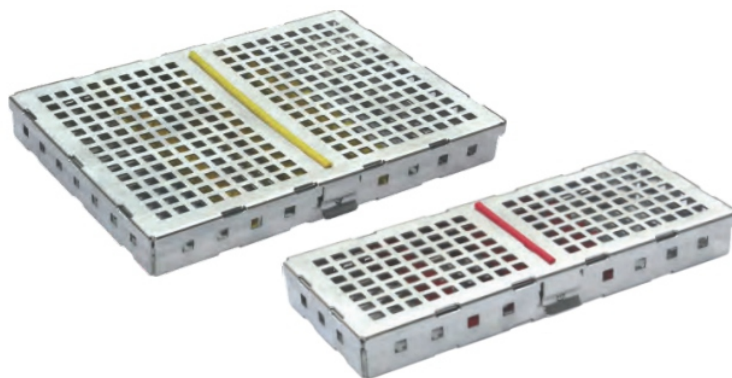

Square

Dimension(mm)

DS-4007	05DS-Instruments	180 x 70 x 22
DS-4008	10DS-Instruments	180 x 130 x 22
DS-4009	20DS-Instruments	260 x 180 x 22

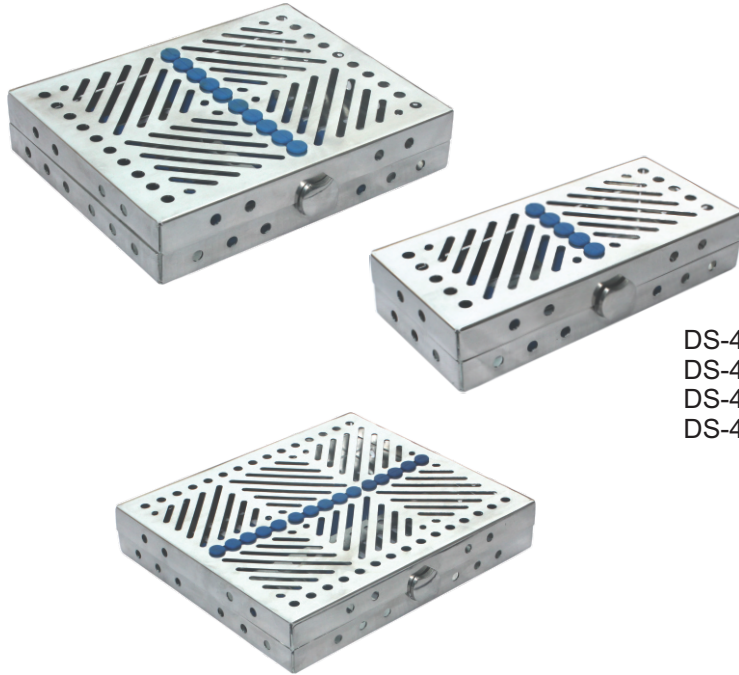

Elongated Holes

Model	Instruments	Dimension(mm)
DS-4010	05DS-Instruments	180 x 80 x 35
DS-4011	10DS-Instruments	180 x 145 x 35
DS-4012	15DS-Instruments	210 x 180 x 35
DS-4013	20DS-Instruments	280 x 180 x 35

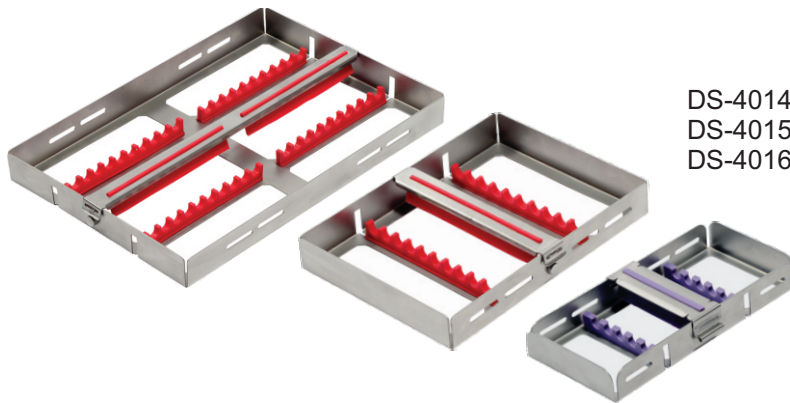

Strip Lock "H" Type

Model	Instruments	Dimension(mm)
DS-4014	05DS-Instruments	180 x 80 x 25
DS-4015	10DS-Instruments	180 x 130 x 25
DS-4016	20DS-Instruments	260 x 180 x 25

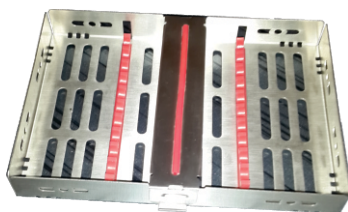

Strip Lock

Model	Instruments	Dimension(mm)
DS-4017	05DS-Instruments	180 x 80 x 25
DS-4018	10DS-Instruments	180 x 130 x 25
DS-4019	20DS-Instruments	260 x 180 x 25

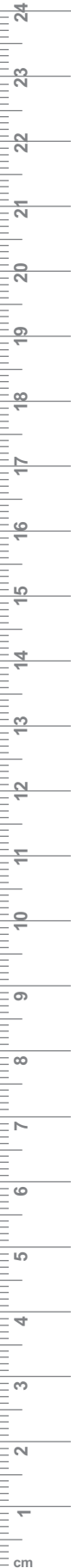



	<u>Dimension(mm)</u>
DS-4020	405 x 255 x 50
DS-4021	405 x 255 x 70
DS-4022	405 x 255 x 100



	<u>Dimension(mm)</u>
DS-4023	255 x 245 x 50
DS-4024	255 x 245 x 70
DS-4025	255 x 245 x 100



	<u>Dimension(mm)</u>
DS-4026	255 x 120 x 50
DS-4027	255 x 120 x 70

LIDs (optional)

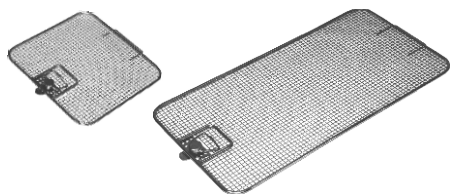

	<u>Dimension(mm)</u>
DS-4028	255 x 120
DS-4029	255 x 245
DS-4030	250 x 240
DS-4031	540 x 255
DS-4032	485 x 255
DS-4033	405 x 255
DS-4034	480 x 370
DS-4035	480 x 250

Endoscopic Baskets

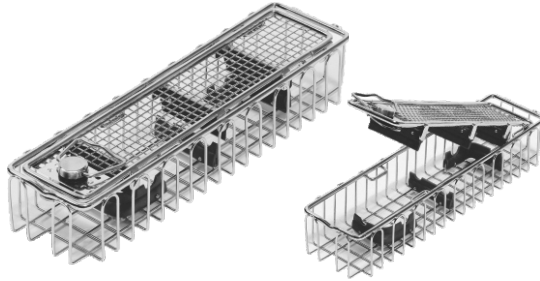

	<u>Dimension(mm)</u>
DS-4036	290 x 80 x 52
DS-4037	460 x 80 x 52

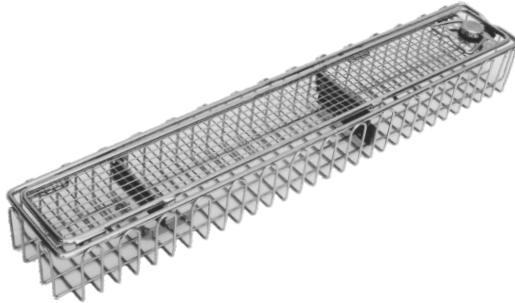

	<u>Dimension(mm)</u>
DS-4038	670 x 80 x 52
DS-4039	700 x 80 x 52



	<u>Dimension(mm)</u>
DS-4040	290 x 160 x 52
DS-4041	310 x 150 x 77
DS-4042	460 x 160 x 77
DS-4043	640 x 150 x 77
DS-4044	660 x 150 x 77
DS-4045	460 x 160 x 52
DS-4046	580 x 160 x 52

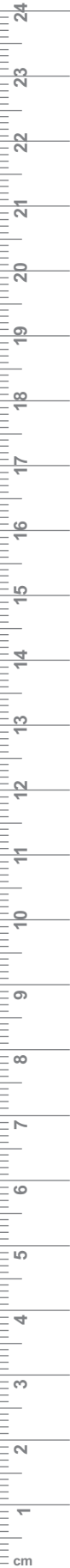



Denis
Surgical

79

- EN** Cylinder cartidge syringe
- DE** ZylinderDS-Ampullenspritze
- ES** Seringue á ampoule cilindrique

Page 211 to 216

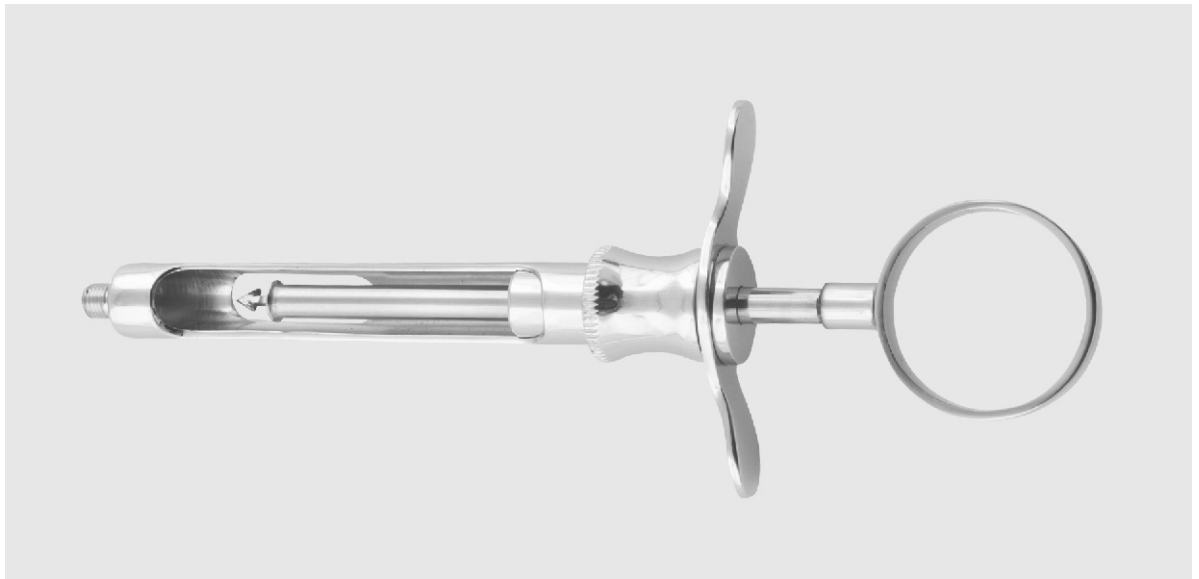



DS-4101

Cylinder cartridge syringe
1.8 cc, without aspiration
metric thread / US Thread

DS-4103

Cylinder cartridge syringe
2.2 cc, without aspiration
metric thread / US Thread

DS-4102

Cylinder cartridge syringe
1.8 cc, with aspiration
metric thread / US Thread

DS-4104

Cylinder cartridge syringe
2.2 cc, with aspiration
metric thread / US Thread



DS-4105

Cylinder cartridge syringe
1.8 cc, without aspiration with
metric thread / US Thread

DS-4107

Cylinder cartridge syringe
2.2 cc, without aspiration with
metric thread / US Thread

DS-4106

Cylinder cartridge syringe
1.8 cc, with aspiration with
metric thread / US Thread

DS-4108

Cylinder cartridge syringe
2.2 cc, with aspiration with
metric thread / US Thread

Cartridge syringes ● EN

Ampullenspritzen ● DE

Jeringas para cartucho apollas ● ES



DS-4109

Cylinder cartridge syringe
1.8 cc, without aspiration
metric thread / US Thread

DS-4111

Cylinder cartridge syringe
2.2 cc, without aspiration
metric thread / US Thread

DS-4110

Cylinder cartridge syringe
1.8 cc, with aspiration
metric thread / US Thread

DS-4112

Cylinder cartridge syringe
2.2 cc, with aspiration
metric thread / US Thread



DS-4113

Cylinder Cartridge Syringe
1.8cc without Aspiration
metric thread / US Thread

DS-4115

Cylinder Cartridge Syringe
2.2cc without Aspiration
metric thread / US Thread

DS-4114

Cylinder Cartridge Syringe
1.8cc with Aspiration
metric thread / US Thread

DS-4116

Cylinder Cartridge Syringe
2.2cc with Aspiration
metric thread / US Thread

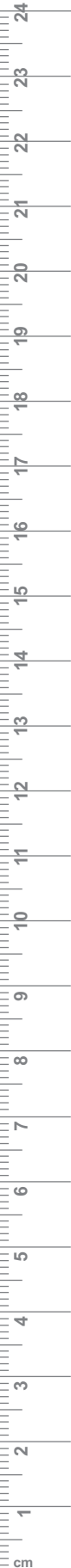



DS-4117
Cylinder Cartridge Syringe
1.8cc without Aspiration
metric thread / US Thread
Plastic base & handle sand blast
finish steel rod.

DS-4119
Cylinder Cartridge Syringe
2.2cc without Aspiration
metric thread / US Thread
Plastic base & handle sand blast
finish steel rod.

DS-4118
Cylinder Cartridge Syringe
1.8cc with Aspiration
metric thread / US Thread
Plastic base & handle sand blast
finish steel rod.

DS-4120
Cylinder Cartridge Syringe
2.2cc with Aspiration
metric thread / US Thread
Plastic base & handle sand blast
finish steel rod.



DS-4121
Cylinder Cartridge Syringe
1.8cc without Aspiration
metric thread / US Thread

DS-4123
Cylinder Cartridge Syringe
2.2cc without Aspiration
metric thread / US Thread

DS-4122
Cylinder Cartridge Syringe
1.8cc with Aspiration
metric thread / US Thread

DS-4124
Cylinder Cartridge Syringe
2.2cc with Aspiration
metric thread / US Thread

Cartridge syringes ● EN

Ampullenspritzen ● DE

Jeringas para cartucho apollas ● ES



DS-4125
Cylinder Cartridge Syringe
1.8cc without Aspiration
metric thread / US Thread

DS-4126
Cylinder Cartridge Syringe
1.8cc with Aspiration
metric thread / US Thread

DS-4127
Cylinder Cartridge Syringe
2.2cc without Aspiration
metric thread / US Thread

DS-4128
Cylinder Cartridge Syringe
2.2cc with Aspiration
metric thread / US Thread



DS-4129
Cylinder Cartridge Syringe
1.8cc without Aspiration
metric thread / US Thread

DS-4130
Cylinder Cartridge Syringe
1.8cc with Aspiration
metric thread / US Thread

DS-4131
Cylinder Cartridge Syringe
2.2cc without Aspiration
metric thread / US Thread

DS-4132
Cylinder Cartridge Syringe
2.2cc with Aspiration
metric thread / US Thread

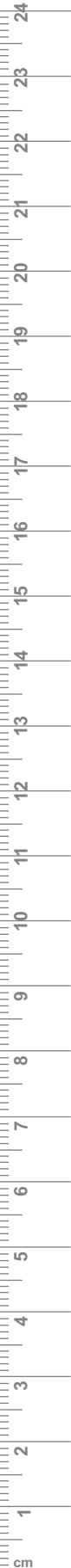



DS-4133
Cylinder Cartridge Syringe
1.8cc without Aspiration
metric thread / US Thread

DS-4134
Cylinder Cartridge Syringe
1.8cc with Aspiration
metric thread / US Thread

DS-4135
Cylinder Cartridge Syringe
2.2cc without Aspiration
metric thread / US Thread

DS-4136
Cylinder Cartridge Syringe
2.2cc with Aspiration
metric thread / US Thread



DS-4137
Aspirating Syringe
1.8cc with fix tip, S/S
metric thread / US Thread

DS-4138
Aspirating Syringe
2.2cc with fix tip, S/S
metric thread / US Thread

Cartridge syringes ● EN
 Ampullenspritzen ● DE
 Jeringas para cartucho apollas ● ES



IntraDS-Ligamentale Syringes



DS-4139
 1.8 cc metric thread / US Thread
 2.2 cc metric thread / US Thread

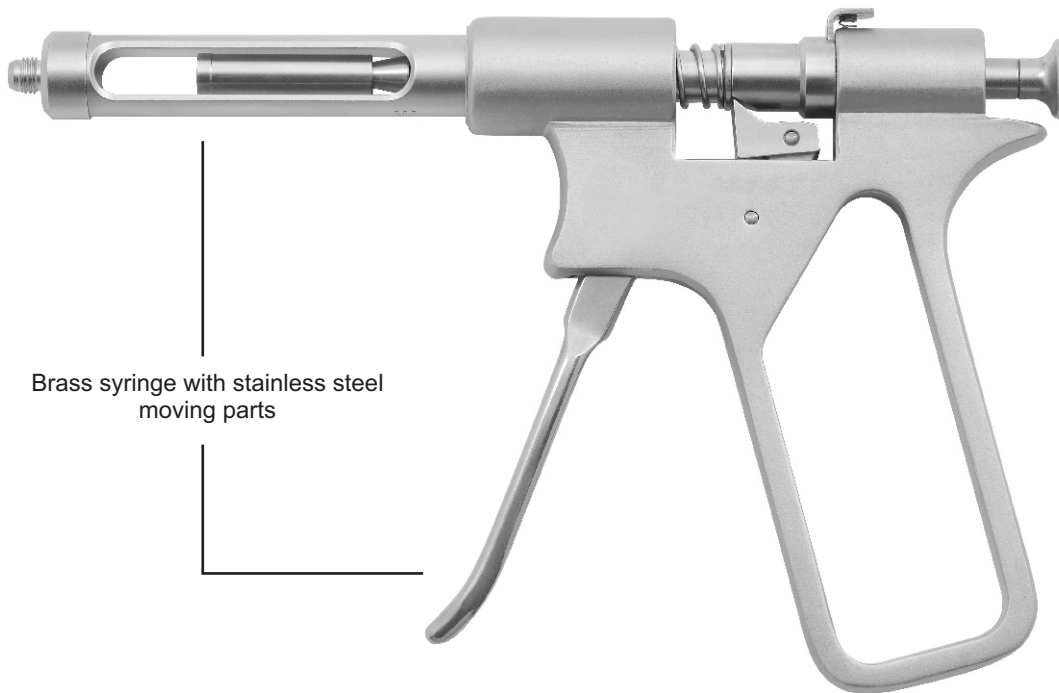

DS-4140
 1.8 cc metric thread / US Thread
 2.2 cc metric thread / US Thread

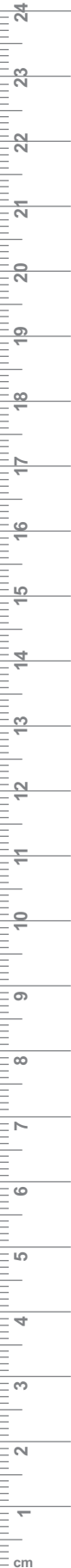



Denis
Surgical

80

EN

Impression Trays

DE

Abdrucklöffel

ES

Porte empreintes

Page 217 to 228



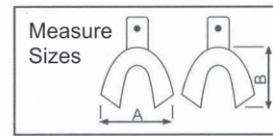
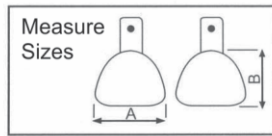
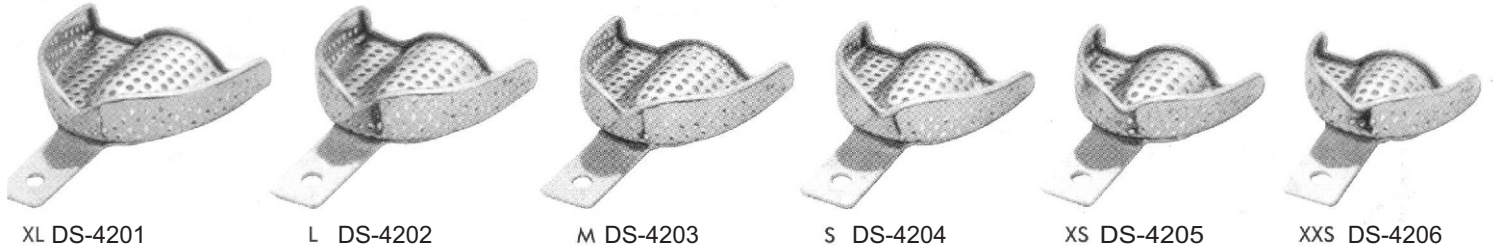

Upper		A (left-right)	B (top-bottom)
80-4201	XL	81 mm	63 mm
80-4202	L	73 mm	58 mm
80-4203	M	71 mm	52 mm
80-4204	S	67 mm	53 mm
80-4205	XS	65 mm	51 mm
80-4206	XXS	61 mm	50 mm

Lower		A (left-right)	B (top-bottom)
80-4207	XL	78 mm	63 mm
80-4208	L	74 mm	62 mm
80-4209	M	72 mm	59 mm
80-4210	S	70 mm	57 mm
80-4211	XS	69 mm	55 mm
80-4212	XXS	59 mm	50 mm

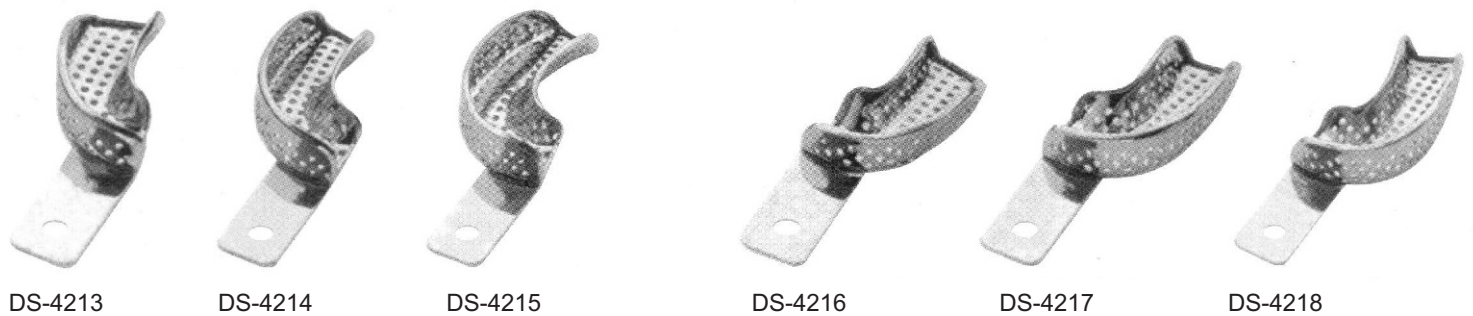
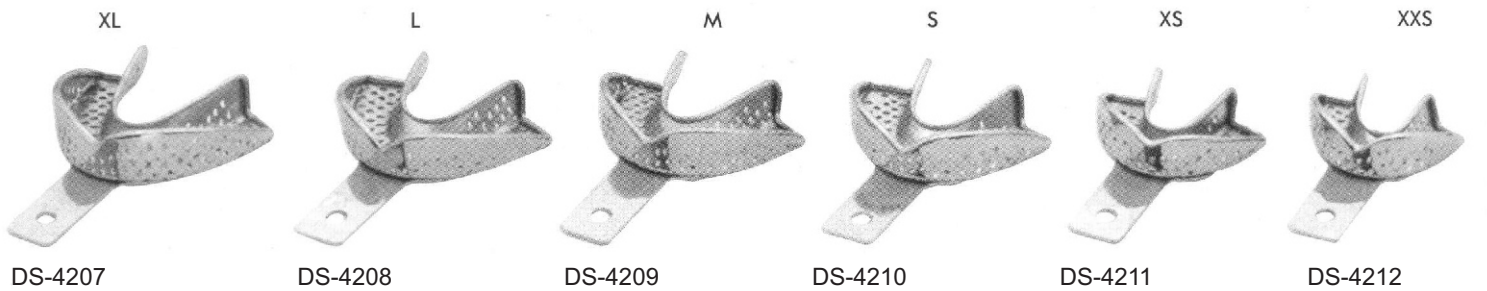

IMPRESSION TRAYS

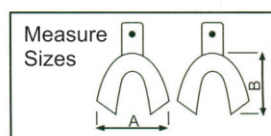
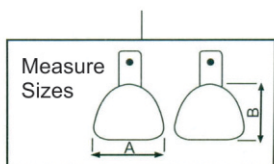
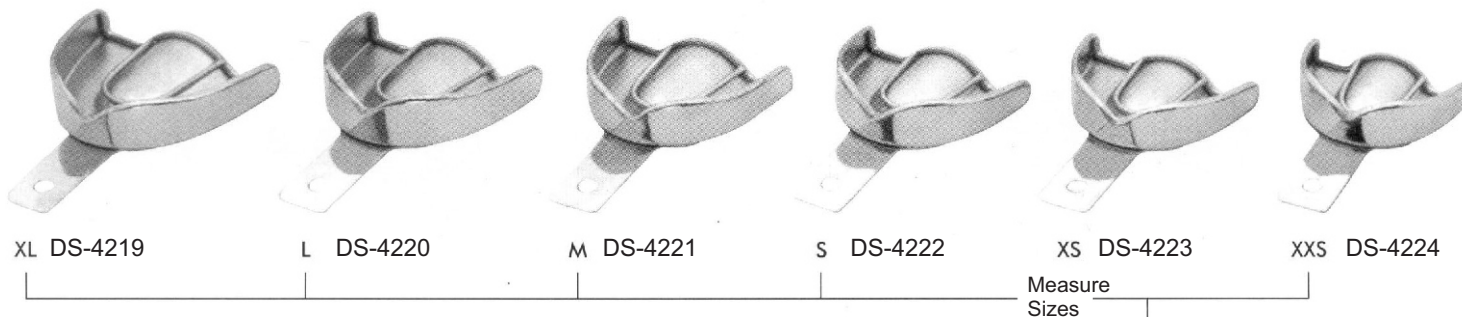

Upper		A (left-right)	B (top-bottom)
81-4219	XL	81 mm	63 mm
81-4220	L	73 mm	58 mm
81-4221	M	71 mm	52 mm
81-4222	S	67 mm	53 mm
81-4223	XS	65 mm	51 mm
81-4224	XXS	61 mm	50 mm

Lower		A (left-right)	B (top-bottom)
81-4225	XL	78 mm	63 mm
81-4226	L	74 mm	62 mm
81-4227	M	72 mm	59 mm
81-4228	S	70 mm	57 mm
81-4229	XS	69 mm	55 mm
81-4201	XXS	59 mm	50 mm

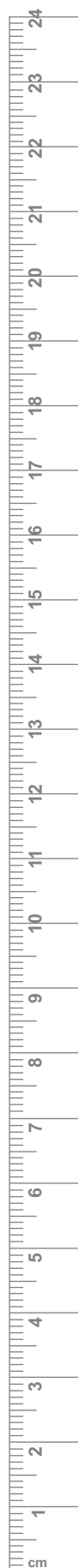
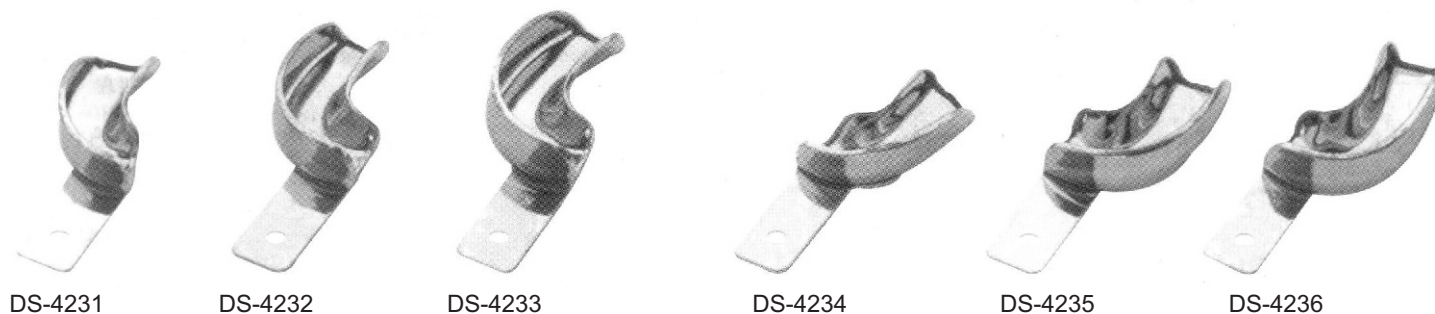
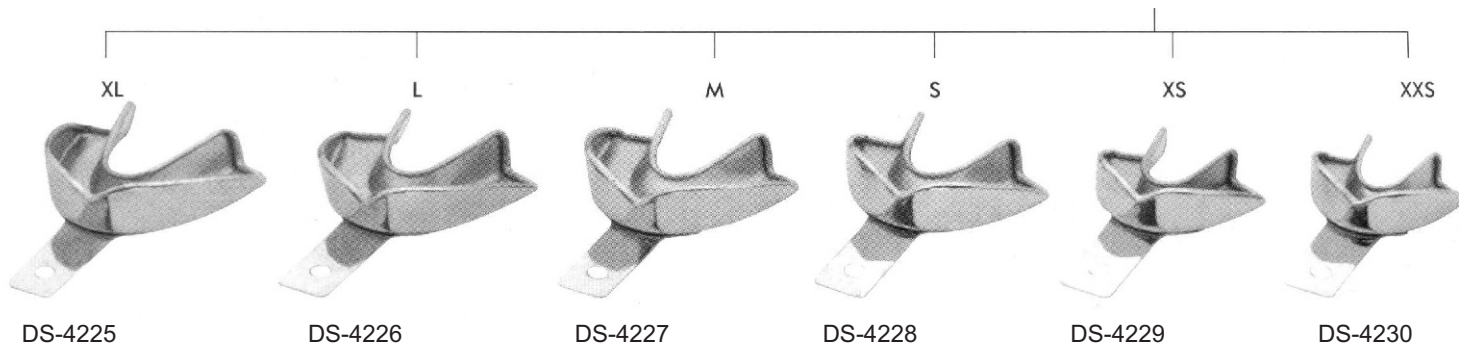

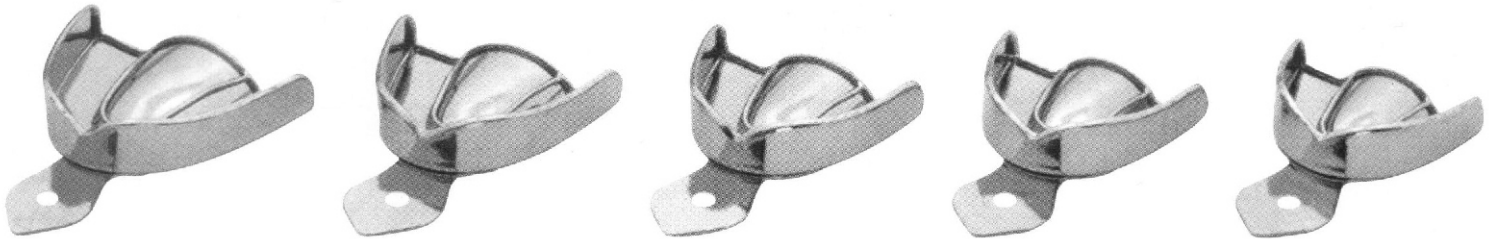

DS-4237

DS-4238

DS-4239

DS-4240

DS-4241

XL

L

M

S

XS

Upper		A (left-right)	B (top-bottom)
DS-4237	XL	81 mm	63 mm
DS-4238	L	73 mm	58 mm
DS-4239	M	71 mm	52 mm
DS-4240	S	67 mm	53 mm
DS-4241	XS	65 mm	51 mm

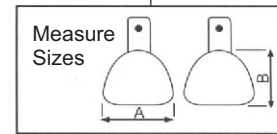

Lower		A (left-right)	B (top-bottom)
DS-4242	XL	78 mm	63 mm
DS-4243	L	74 mm	62 mm
DS-4244	M	72 mm	59 mm
DS-4245	S	70 mm	57 mm
DS-4246	XS	69 mm	55 mm

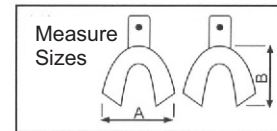

XL

L

M

S

XS

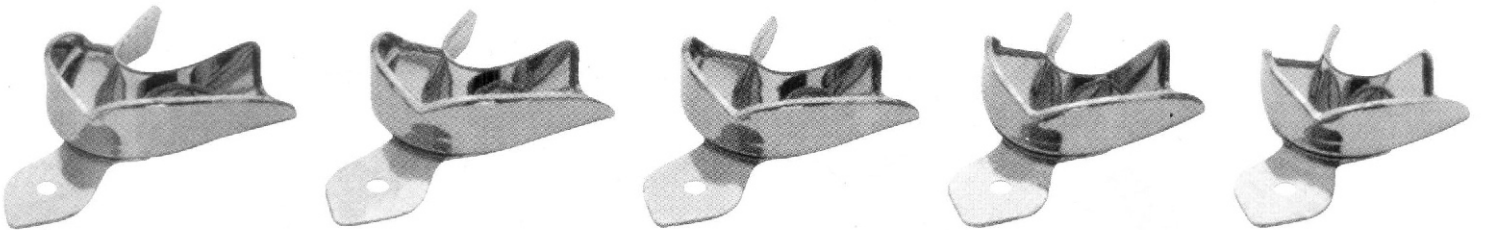

DS-4242

DS-4243

DS-4244

DS-4245

DS-4246

IMPRESSION TRAYS

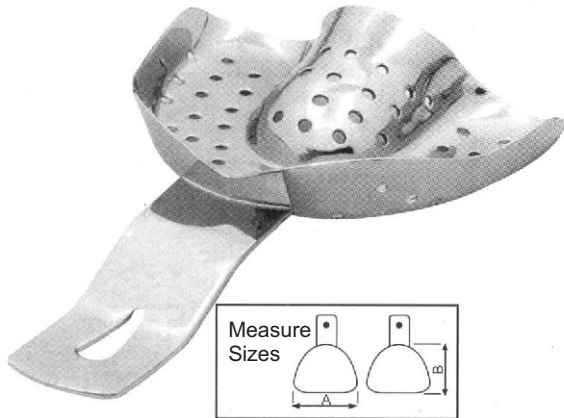

For Toothed Upper Jaws
(Fig. 0 for children)

	A	B
	mm.	mm.
DS-4247	0 59	52
DS-4248	1 66	52
DS-4249	2 71	62
DS-4250	3 71	64
DS-4251	4 80	70

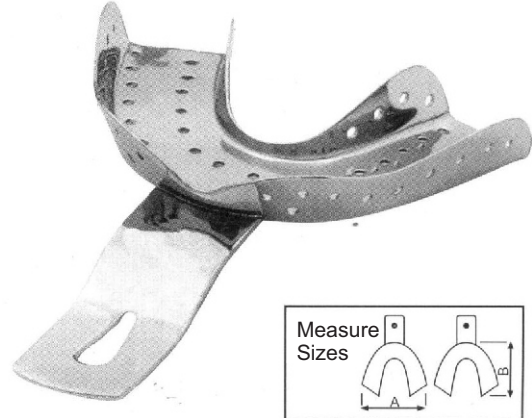

For Toothed Lower Jaws
(Fig. 0 for children)

	A	B
	mm.	mm.
DS-4252	0 65	46
DS-4253	1 67	50
DS-4254	2 76	54
DS-4255	3 79	56
DS-4256	4 79	61

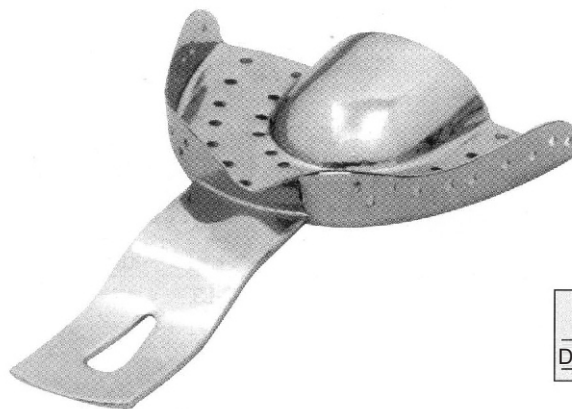

For Narrow Toothed Upper Jaws

	A	B
	mm.	mm.
DS-4257	2 70	54

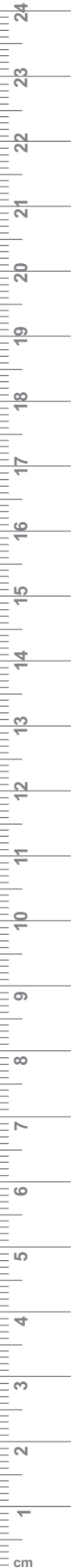

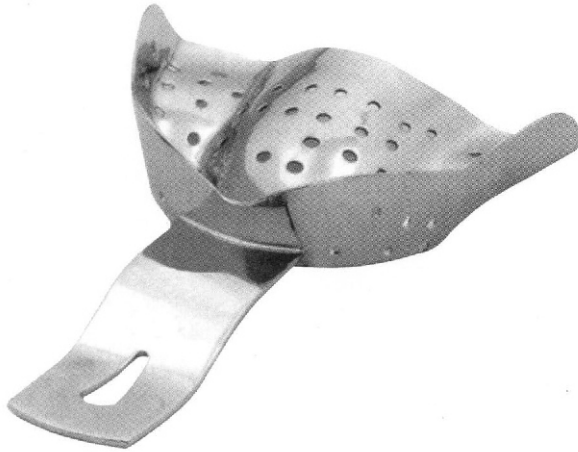

For partially toothed upper jaws

	A	B
	mm.	mm.
DS-4258	1 62	50
DS-4259	2 70	56

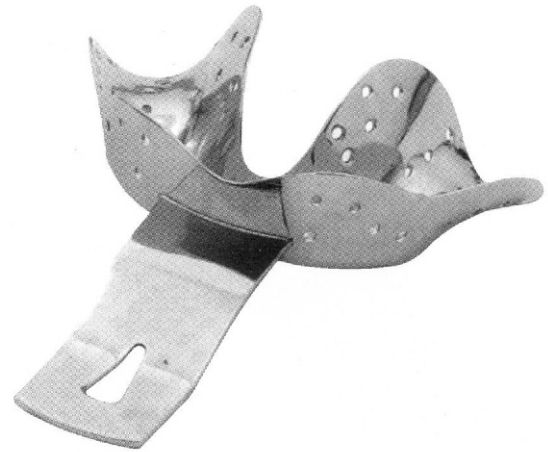
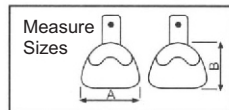

For partially toothed lower jaws

	A	B
	mm.	mm.
DS-4260	1 70	55
DS-4261	2 78	59

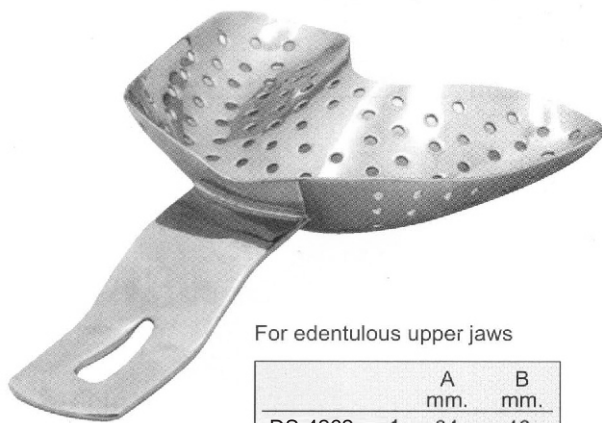
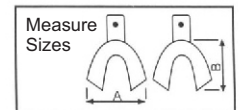

For edentulous upper jaws

	A	B
	mm.	mm.
DS-4262	1 64	46
DS-4263	2 68	53
DS-4264	3 79	61

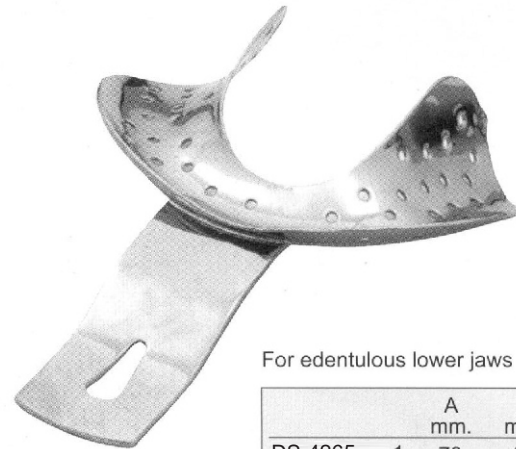

For edentulous lower jaws

	A	B
	mm.	mm.
DS-4265	1 70	48
DS-4266	2 70	53
DS-4267	3 72	57

IMPRESSION TRAYS



Solid stainless steel anterior depressed impression trays with retention rim.

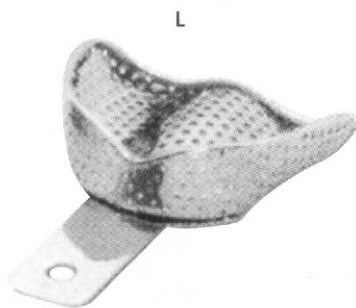
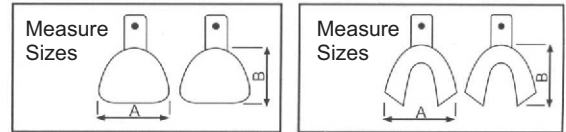

DS-4268

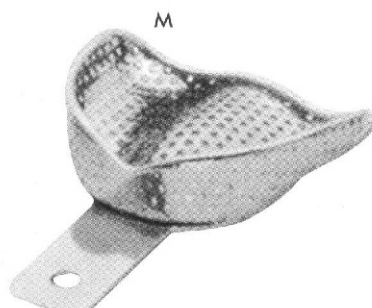

DS-4269

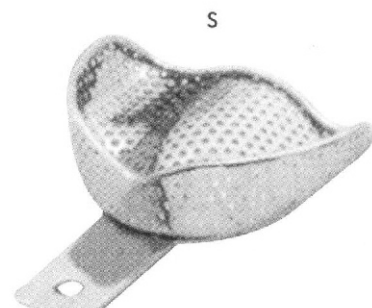

DS-4270

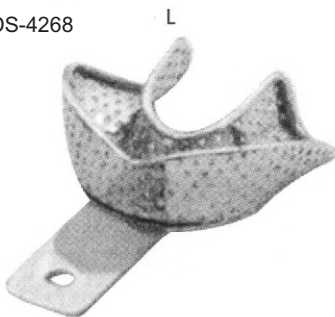

DS-4271

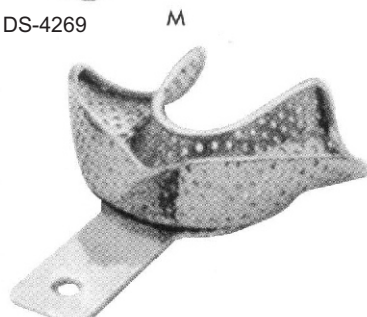

DS-4272

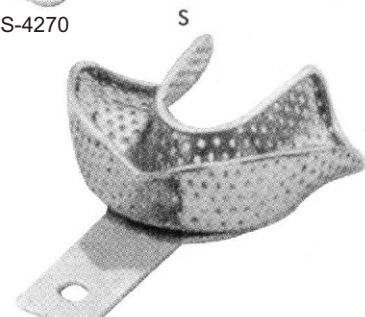

DS-4273

		A mm.	B mm.
DS-4268	L	81	67
DS-4269	M	71	64
DS-4270	S	70	57

		A mm.	B mm.
DS-4271	L	81	60
DS-4272	M	79	57
DS-4273	S	76	54

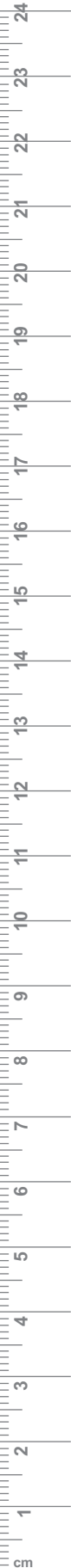



Solid total denture stainless steel impression trays with rim.

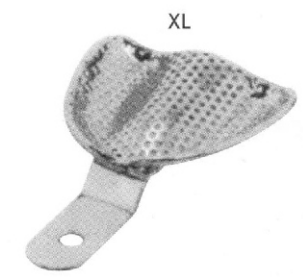
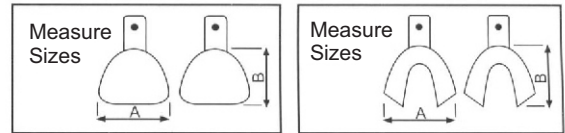

DS-4274

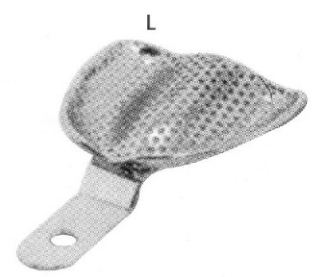

DS-4275

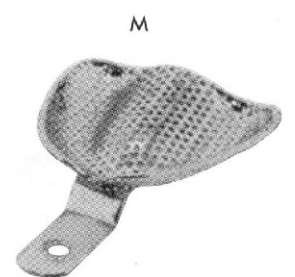

DS-4276

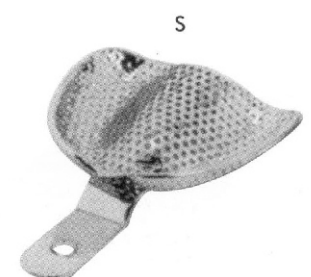

DS-4277

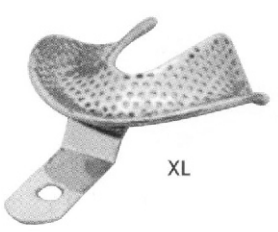

DS-4278

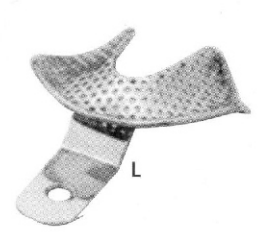

DS-4279

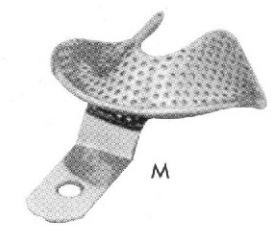

DS-4280

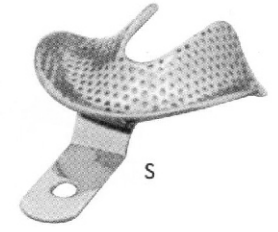

DS-4281

		A mm.	B mm.
DS-4274	XL	79	70
DS-4275	L	76	67
DS-4276	M	70	64
DS-4277	S	73	60

		A mm.	B mm.
DS-4278	XL	86	64
DS-4279	L	70	64
DS-4280	M	73	60
DS-4281	S	70	57

IMPRESSION TRAYS

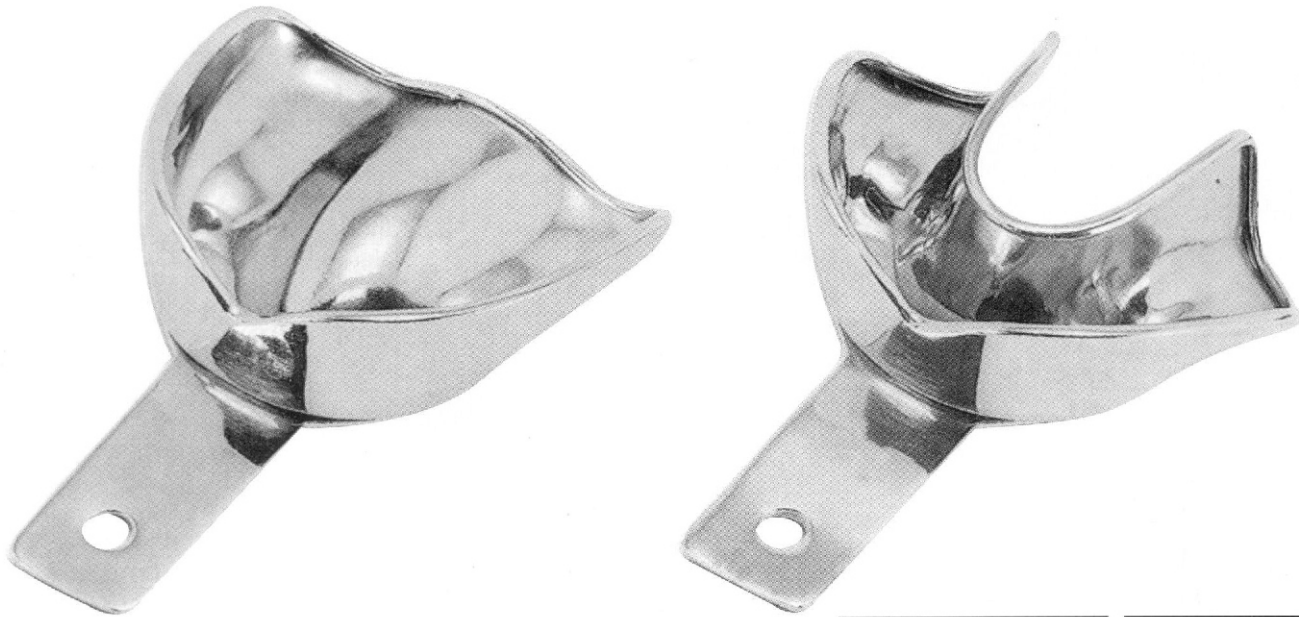

Solid stainless steel anterior depressed impression trays with retention rim.

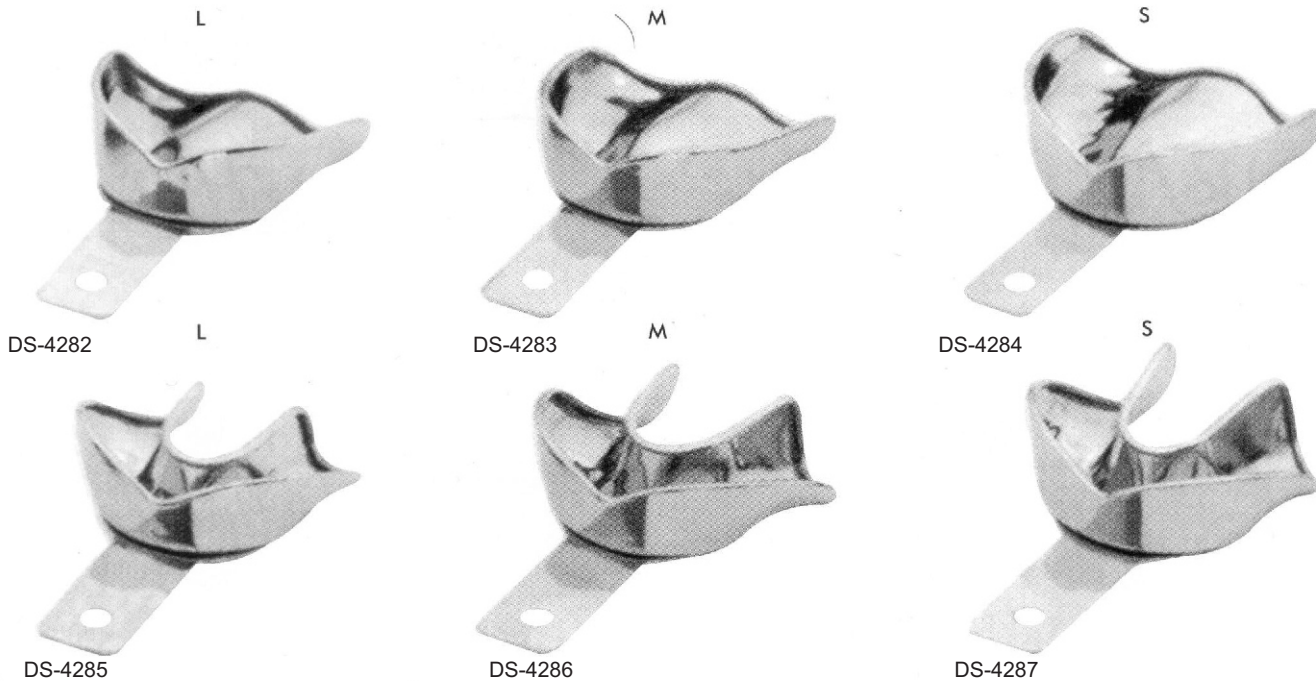
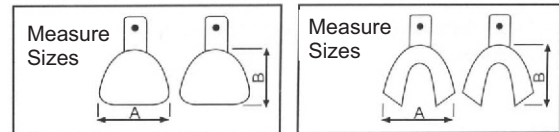

		A	B
		mm.	mm.
DS-4282	L	81	67
DS-4283	M	71	64
DS-4284	S	70	57

		A	B
		mm.	mm.
DS-4285	L	81	60
DS-4286	M	79	57
DS-4287	S	76	54

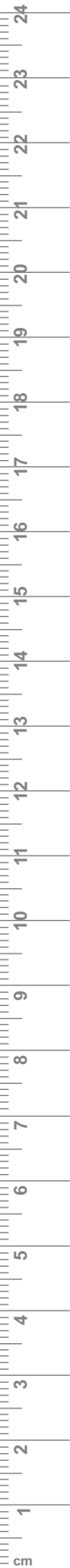

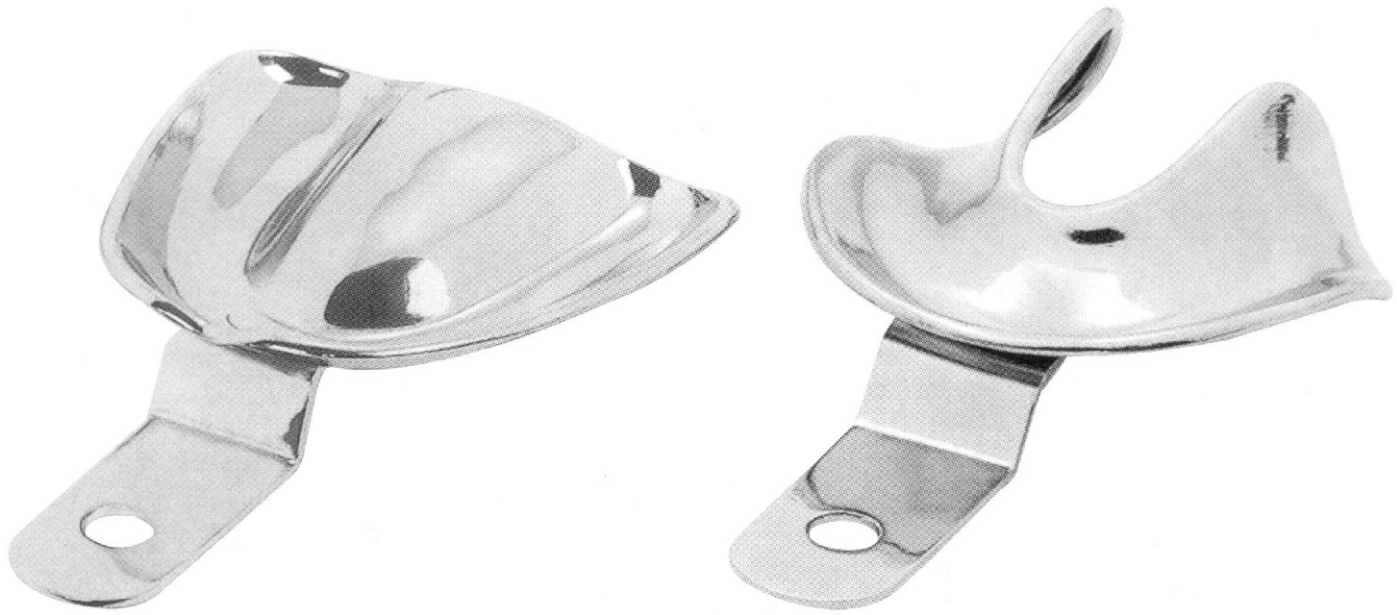

Solid total denture stainless steel impression trays with rim.

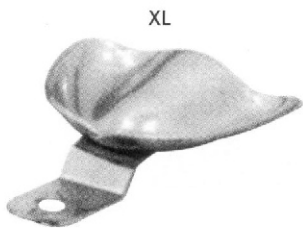
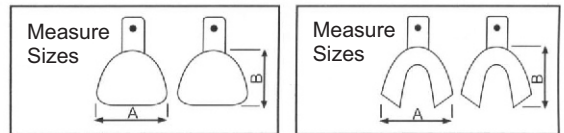

DS-4288

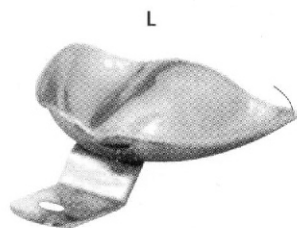

DS-4289

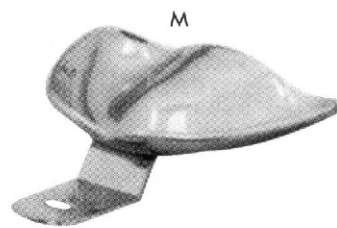

DS-4290

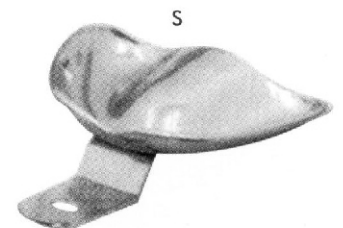

DS-4291



DS-4292

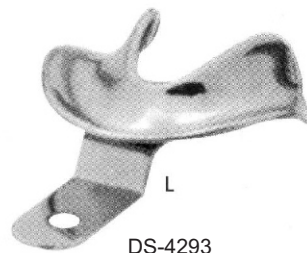

DS-4293

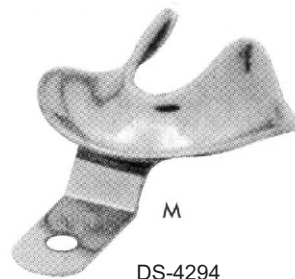

DS-4294

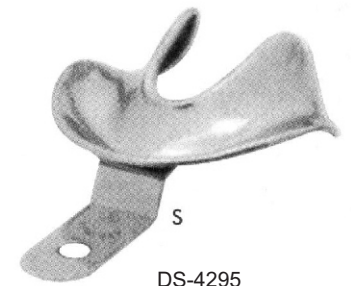

DS-4295

		A mm.	B mm.
DS-4288	XL	79	70
DS-4289	L	76	67
DS-4290	M	70	64
DS-4291	S	73	60

		A mm.	B mm.
DS-4292	XL	86	64
DS-4293	L	70	64
DS-4294	M	73	60
DS-4295	S	70	57

Impression Trays ● EN
 Knochenfeilen ● DE
 Limes à os ● ES

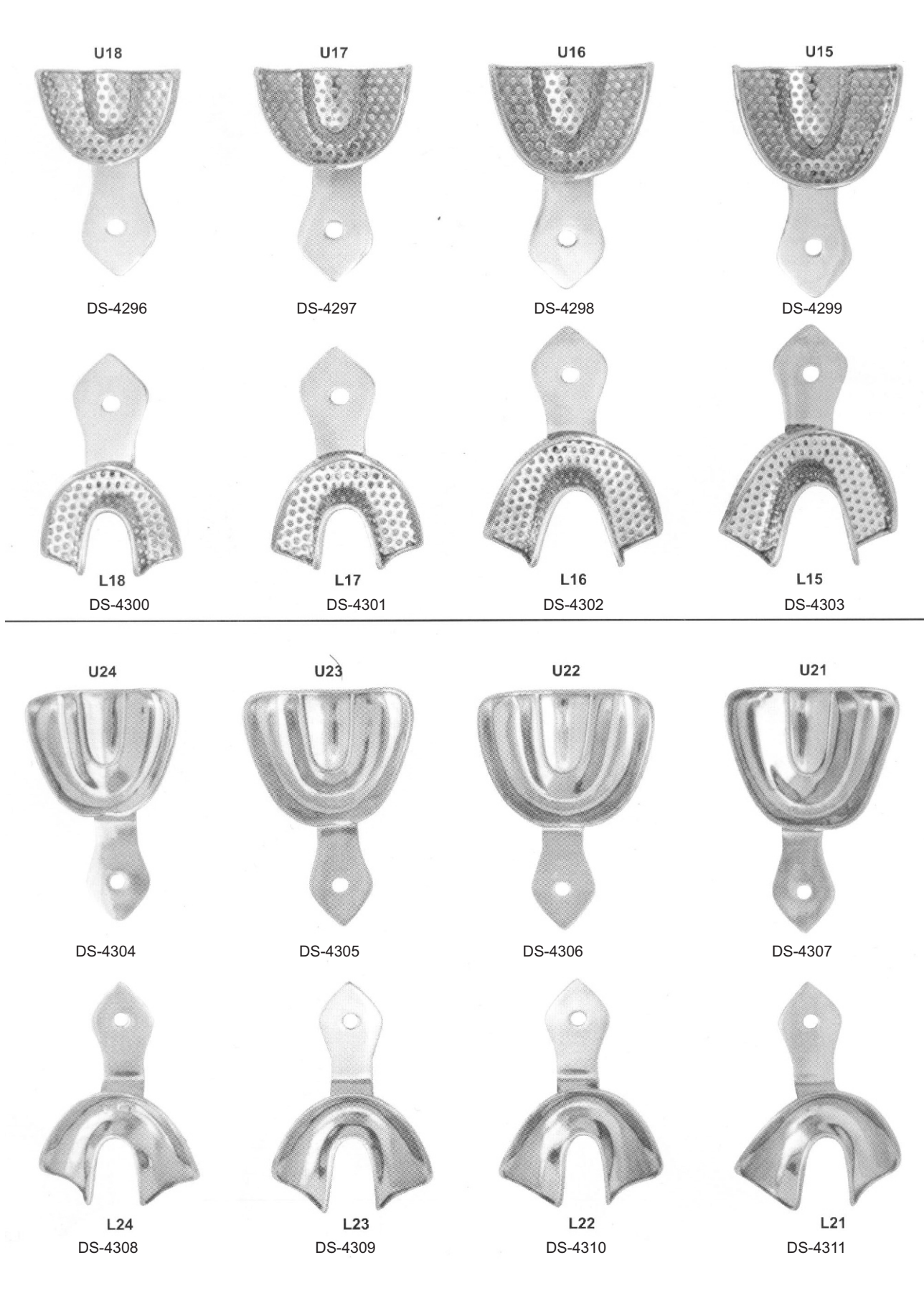

U18



DS-4296

U17



DS-4297

U16



DS-4298

U15



DS-4299

L18

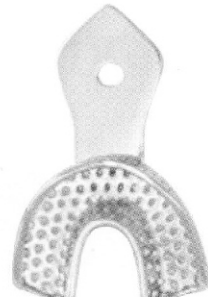

DS-4300

L17

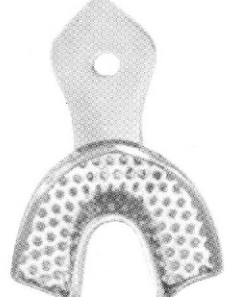

DS-4301

L16

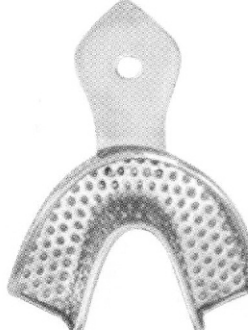

DS-4302

L15

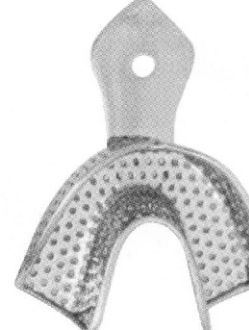

DS-4303

U24



DS-4304

U23



DS-4305

U22

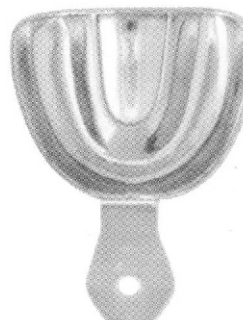

DS-4306

U21



DS-4307

L24



DS-4308

L23



DS-4309

L22



DS-4310

L21



DS-4311

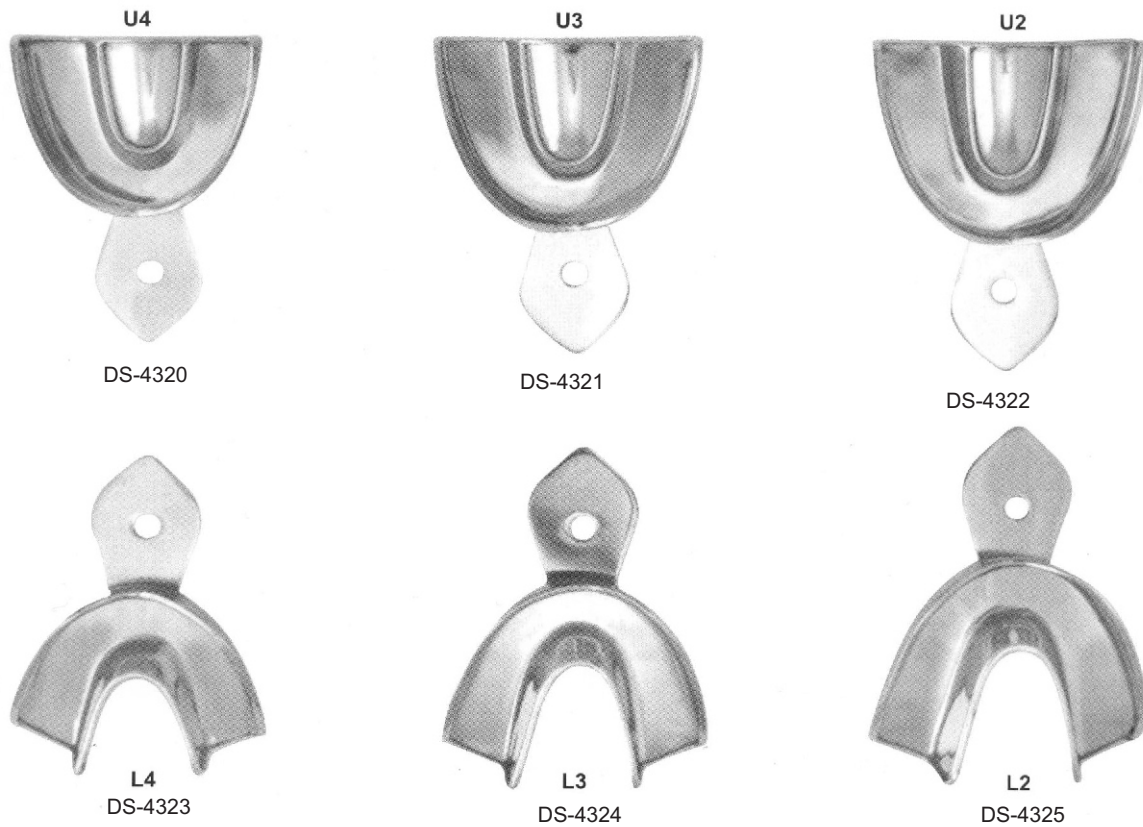
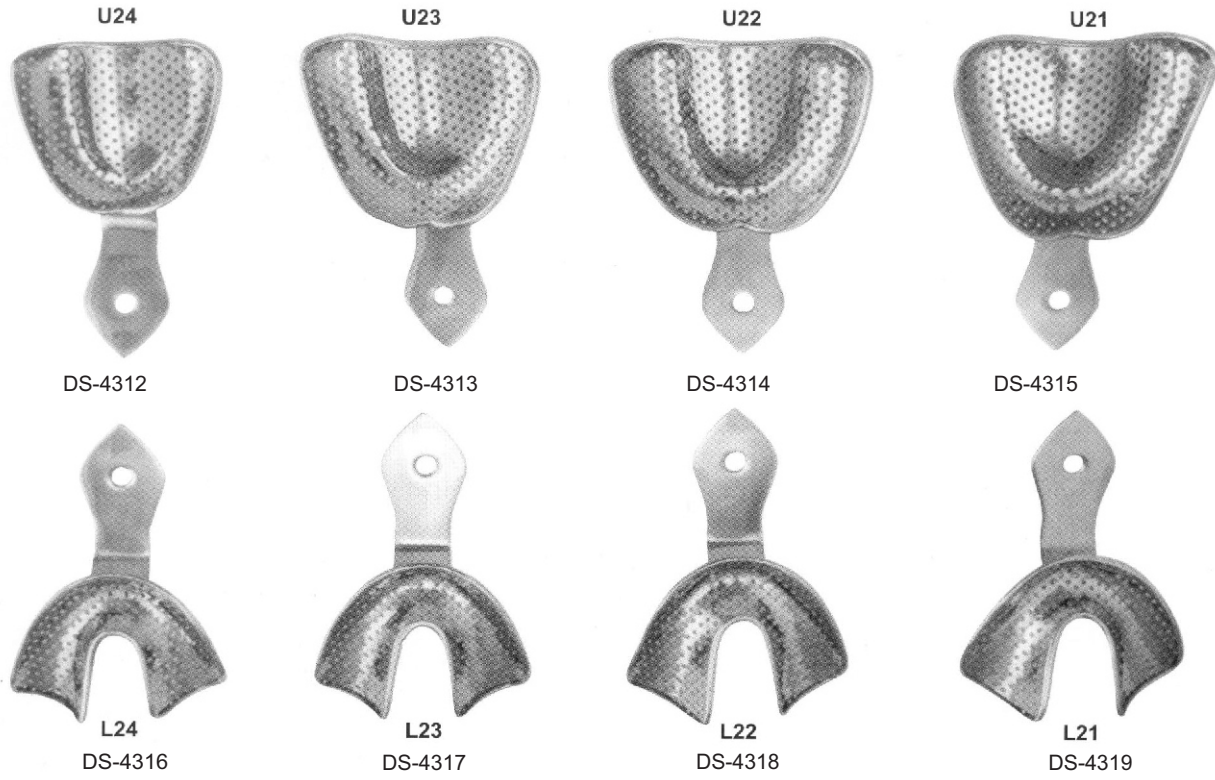

Impression Trays — EN
 Knochenfeilen — DE
 Limes à os — ES

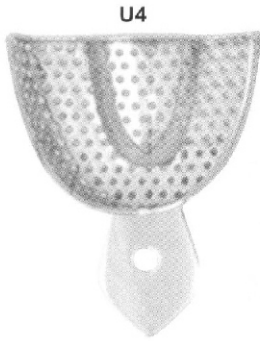

U4

DS-4326

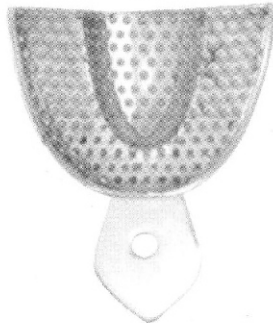

U3

DS-4327



U2

DS-4328

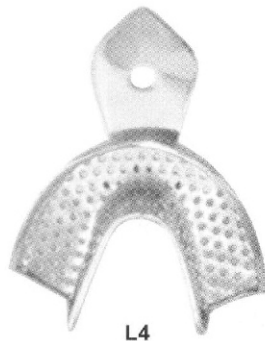

L4

DS-4329

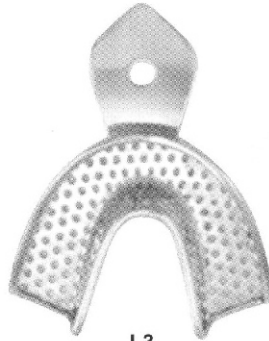

L3

DS-4330

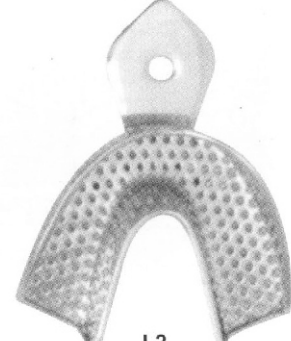

L2

DS-4331



U15

DS-4332



U16

DS-4333



U17

DS-4334



U18

DS-4335



L15

DS-4336



L16

DS-4337

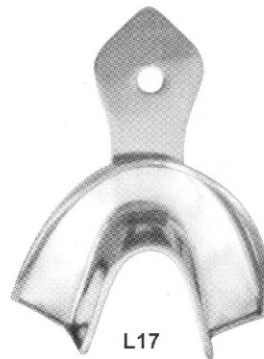

L17

DS-4338

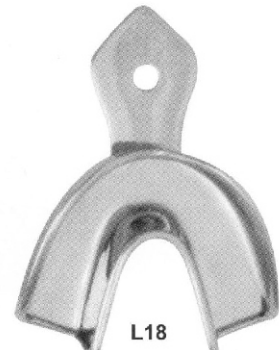

L18

DS-4339





Denis
Surgical

81

EN

Articulators

DE

Artikulatoren

ES

Articuladores

Page 229 to 230



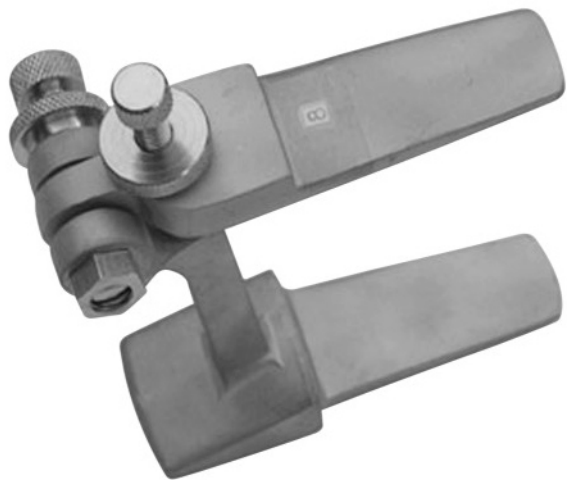

DS-4301



DS-4302



DS-4303



DS-4304



DS-4306



DS-4305



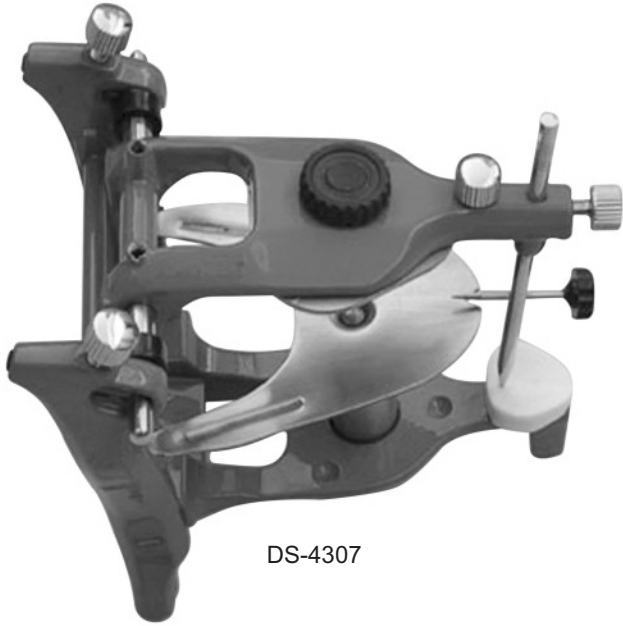

DS-4307



DS-4308



DS-4309



DS-4310



DS-4312



DS-4311



DS-4313

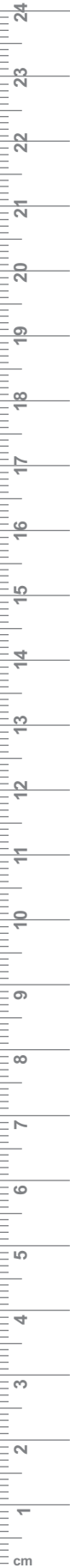



Denis
Surgical

82

EN	Holloware
DE	Holloware
ES	holloware

Page 231 to 234





Needle Case Round with Cover
DS-4401 65x15mm



Needle Case Round
DS-4402 80x20mm



Needle Case Rectangle
DS-4403 70x70x10mm

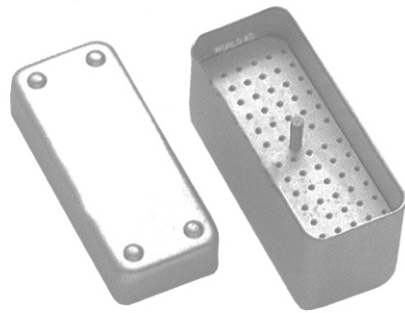

Endodontic Box
DS-4404
100x40x50mm

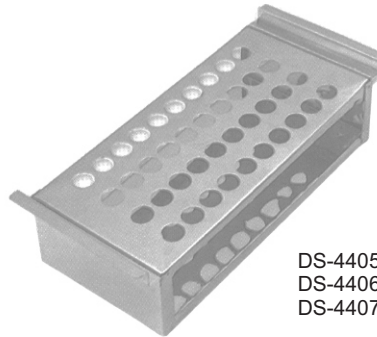

Tube Rack

DS-4405 6.35x15.25x5cm for 12 tubes
DS-4406 6.35x17.75x7.5cm for 27 tubes
DS-4407 7.50x17.75x6.35cm for 36 tubes



Sprit Lamp
DS-4408
Standard Size



Sprit Lamp
DS-4409
Standard Size

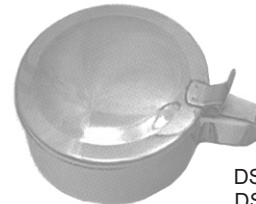

Sputum Cup
DS-4410 75x80mm
DS-4411 100x50mm
DS-4412 100x80mm



Dressing Jar

DS-4413	80x60mm	DS-4420
DS-4414	80x80mm	DS-4421
DS-4415	100x100mm	DS-4423
DS-4416	120x120mm	DS-4424
DS-4417	150x150mm	DS-4425
DS-4418	180x180mm	DS-4426
DS-4419	200x200mm	DS-4427



Dressing Jar



Fennle
DS-4428 100mm Ø
DS-4429 120mm Ø
DS-4430 150mm Ø
DS-4431 200mm Ø



Cotton Holder
DS-4432



Cotton Holder
DS-4433





Forceps Jar

- DS-4434 30x90mm
- DS-4435 50x125mm
- DS-4436 50x170mm
- DS-4437 50x200mm
- DS-4438 40x230mm
- DS-4439 70x110mm
- DS-4440 80x150mm
- DS-4441 100x200mm
- DS-4442 150x30mm

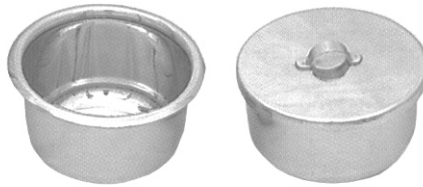

Gallipot

- | | |
|---------------|---------------|
| DS-4443 01 oz | DS-4450 09 oz |
| DS-4444 02 oz | DS-4451 10 oz |
| DS-4445 03 oz | DS-4452 11 oz |
| DS-4446 04 oz | DS-4453 12 oz |
| DS-4447 05 oz | DS-4454 13 oz |
| DS-4448 06 oz | DS-4455 14 oz |
| DS-4448 07 oz | DS-4456 15 oz |
| DS-4449 08 oz | DS-4457 16 oz |



Sponge Bowl

- DS-4458 12 cm
- DS-4459 15 cm
- DS-4460 20 cm



Lotion Bowl without spout

- | | |
|------------------|--------------------|
| DS-4464 40x19mm | DS-4471 150x65mm |
| DS-4465 50x25mm | DS-4472 180x85mm |
| DS-4466 60x30mm | DS-4473 200x100mm |
| DS-4467 80x40mm | DS-4474 250x120mm |
| DS-4468 100x50mm | DS-4475DS-12 300mm |
| DS-4469 120x60mm | DS-4476DS-13 350mm |
| DS-4470 140x60mm | DS-4477DS-14 400mm |



Wash Basin

- DS-4478 300x80mm
- DS-4479 320x85mm
- DS-4480 330x90mm
- DS-4481 350x110mm
- DS-4482 400x115mm



Medicine Cup

- DS-4461 50ml
- DS-4462 60ml
- DS-4463 70ml



Kick Bucket with Trolley
 30DS-6819DS-01
 390x280x180mm



Kidney Tray Shallow

- DS-4483 17cm
- DS-4484 22cm
- DS-4485 24cm



Kidney Tray

- DS-4486 12cm
- DS-4487 15cm
- DS-4488 18cm
- DS-4489 20cm
- DS-4490 25cm
- DS-4491 28cm
- DS-4492 30cm



Kidney Tray (with cover)

- DS-4493 15cm
- DS-4494 20cm
- DS-4495 25cm
- DS-4496 30cm

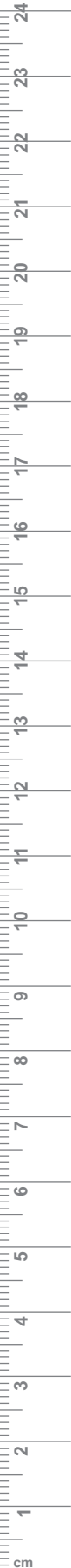

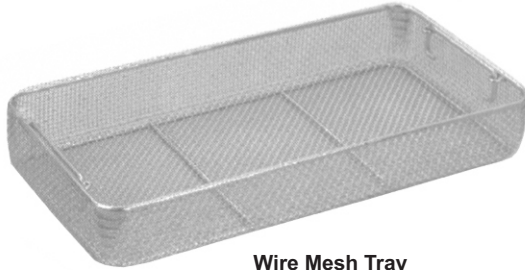

Wire Mesh Tray

- DS-4497 240x250x5mm
- DS-4498 480x250x5mm
- DS-4499 550x250x5mm
- DS-4500 240x250x7mm
- DS-4501 480x250x7mm
- DS-4502 240x250x10mm
- DS-4503 480x250x10mm

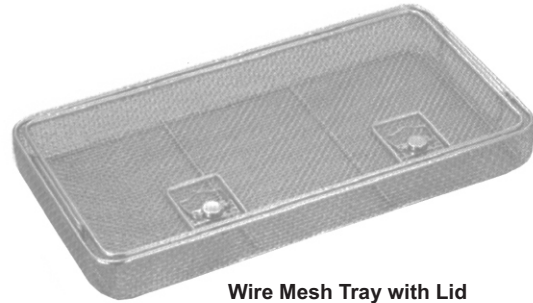

Wire Mesh Tray with Lid

- DS-4504 240x250x5mm
- DS-4505 480x250x5mm
- DS-4506 550x250x5mm
- DS-4507 240x250x7mm
- DS-4508 480x250x7mm
- DS-4509 240x250x10mm
- DS-4510 480x250x10mm



Perforated Tray

- DS-4511 200x100x40mm
- DS-4512 250x120x50mm
- DS-4513 300x150x50mm
- DS-4514 350x170x50mm
- DS-4515 400x200x50mm



Instruments Tray without Lid

- DS-4516 100x150x25mm
- DS-4517 150x200x40mm
- DS-4518 200x250x45mm
- DS-4519 250x300x50mm
- DS-4520 300x350x50mm
- DS-4521 150x300x50mm
- DS-4522 200x300x50mm
- DS-4523 230x150x50mm



Instruments Tray with Lid

- DS-4524 100x150x25mm
- DS-4525 150x200x40mm
- DS-4526 200x250x45mm
- DS-4527 250x300x50mm
- DS-4528 300x350x50mm
- DS-4529 150x300x50mm
- DS-4530 200x300x50mm
- DS-4531 230x150x50mm

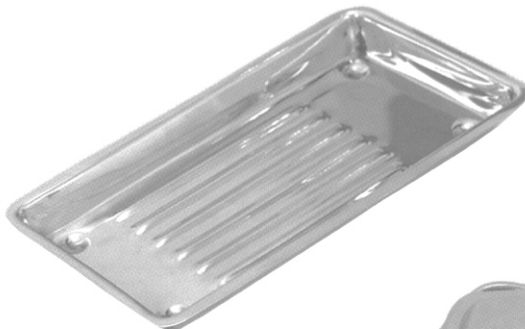

Burr Tray

- DS-4532
190x100x20mm

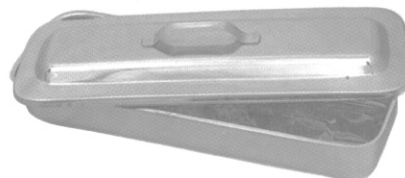

Cathetes Tray with Lid

- DS-4533 300x80x40mm
- DS-4534 350x90x45mm
- DS-4535 400x100x50mm

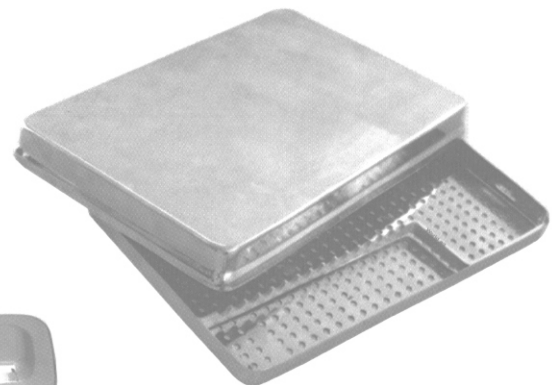

Scaler Tray with cover

- DS-4536
200x100x16mm



Hollowware ● EN
 Hohlkörper ● DE
 Hollowware ● ES



**Instruments Box
with Hooks**

- DS-4537 170x70x30mm
- DS-4538 180x80x40mm
- DS-4539 200x100x40mm
- DS-4540 230x120x50mm
- DS-4541 250x125x50mm
- DS-4542 300x150x50mm
- DS-4543 350x170x50mm
- DS-4544 400x200x90mm
- DS-4545 500x200x120mm



Instruments Box

- DS-4546 170x70x30mm
- DS-4547 180x80x40mm
- DS-4548 200x100x40mm
- DS-4549 230x120x50mm
- DS-4550 250x125x50mm
- DS-4551 300x150x50mm
- DS-4552 350x170x50mm
- DS-4553 400x200x90mm
- DS-4554 500x200x120mm



**Instruments Box
Perforated**

- DS-4555 200x100x40mm
- DS-4556 250x150x40mm
- DS-4557 300x150x40mm



Electric Sterilizer

- DS-4558 200x100x120mm
- DS-4559 250x120x140mm
- DS-4560 300x150x150mm
- DS-4561 350x170x170mm
- DS-4562 400x200x180mm
- DS-4563 450x230x190mm



Non Electric Sterilizer

- DS-4564 200x100x65mm
- DS-4565 250x125x65mm
- DS-4566 300x150x100mm
- DS-4567 350x170x65mm
- DS-4568 400x200x100mm



Electric Sterilizer
DS-4569
280x125x65mm

- DS-4570 125x80mm
- DS-4571 125x120mm
- DS-4572 150x100mm
- DS-4573 150x150mm
- DS-4574 180x180mm
- DS-4575 190x140mm
- DS-4576 190x190mm
- DS-4577 200x200mm
- DS-4578 240x120mm
- DS-4579 240x240mm
- DS-4580 290x140mm
- DS-4581 290x240mm
- DS-4582 290x290mm
- DS-4583 340x160mm
- DS-4584 340x340mm
- DS-4585 390x150mm
- DS-4586 390x200mm
- DS-4587 390x290mm



Sterilizer Drum



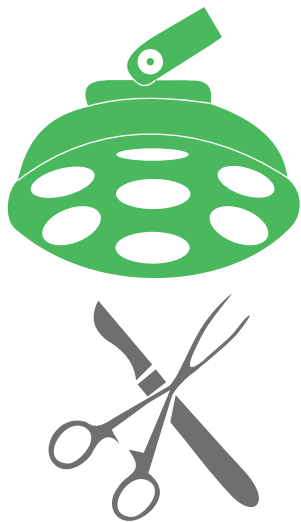

Denis
Surgical

Office Address
Vill.Harar,P.O Khas
Sialkot DS- 51310, Pakistan.

Call Us

Tel: 052 3252297

Tel: +92 345 6731954

Email

denisveterinarsurgical@gmail.com

www.denissurgical.com